

EU Declaration of Conformity

SAMSUNG



We hereby declare that the product

Type of equipment : NETWORK CAMERA
Brand Name / Trade Mark : SAMSUNG
Model number : QND-7080RP
Variant Model : -

satisfies all the technical regulations applicable to the product within the scope of Council Directives 2014/30/EU

EN 55022:2010 : Limits and methods of measurement of radio disturbance characteristics of information technology equipment
EN 50581:2012 : Technical documentation for the assessment of electrical and electronic products with respect to the restriction of hazardous substances
EN 50130-4:2011+A1:2014 : Product family standard: Immunity requirements for components of fire, intruder and social alarm systems
EN 61000-4-2:2009 : Electrostatic discharge immunity test
EN 61000-4-3:2006+A2:2010 : Radiated, radio-frequency, electromagnetic field immunity test
EN 61000-4-4:2012 : Electrical fast transient/burst immunity test
EN 61000-4-5:2014 : Surge immunity test
EN 61000-4-6:2009 : Immunity to conducted disturbances, induced by radio-frequency fields

All essential testing suites have been carried out.

Manufacturer : Tianjin Samsung Techwin Opto-Electronic Co., Ltd.
Manufacturer address : No.11 Weiliu Rd, Micro-Electronic Industrial Park, TEDA, Tianjin, 300385, People's Republic of China
Telephone / Fax : 82-02-729-2900 / 82-02-729-2904 (www.hanwhatechwin.com)
Applicant : Hanwha Techwin Co., Ltd.
Applicant address : 1204, Changwon-daero, Seongsan-gu, Chang-won-si, Gyeongsangnam-do, Korea

This declaration is issued under the sole responsibility of the manufacturer and his authorised representative.

Authorized signatory

Name / Title : Jei Soon, Kang / Principal Research Engineer
Date of issue : Jul. 10, 2016



EMC TEST REPORT For CE

Test Report No. : KES-E1-16T0336
Date of Issue : Jul. 10, 2016
Product name : NETWORK CAMERA
Model/Type No. : QND-7080RP
Variant Model : -
Applicant : Hanwha Techwin Co., Ltd.
Applicant Address : 1204, Changwon-daero, Seongsan-gu, Changwon-si,
Gyeongsangnam-do, Korea
Manufacturer : Tianjin Samsung Techwin Opto-Electronic Co., Ltd.
Manufacturer Address : No.11 Weiliu Rd, Micro-Electronic Industrial Park, TEDA,
Tianjin,
300385, People's Republic of China
Date of Receipt : Jun. 16, 2016
Test date : Jun. 27, 2016 – Jul. 01, 2016
Test Results : **In Compliance** **Not in Compliance**

Tested by

Dae Jung, Choi
EMC Test Engineer

Reviewed by

Dong-Hun, Jang
EMC Technical Manager



KES Co., Ltd.

C-3701, Simin-daero 365-40,
Dongan-gu, Anyang-si, Gyeonggi-do, 14057, Korea
Tel: +82-31-425-6200 / Fax: +82-31-424-0450
www.kes.co.kr

Test report No.:
KES-E1-16T0336
Page (2) of (78)

REPORT REVISION HISTORY

Date	Test Report No.	Revision History
Jul. 10, 2016	KES-E1-16T0336	Issued

This report shall not be reproduced except in full, without the written approval of KES Co., Ltd. This document Jun be altered or revised by KES Co., Ltd. personnel only, and shall be noted in the revision section of the document. Any alteration of this document not carried out by KES Co., Ltd. will constitute fraud and shall nullify the document.

This report shall not be reproduced except in full, without the written approval of KES Co., Ltd.
The results shown in this test report refer only to the sample(s) tested unless otherwise stated.



TABLE OF CONTENTS

1.0	General Product Description	4
1.1	Test Voltage & Frequency	6
1.2	Variant Model Differences.....	6
1.3	Device Modifications	6
1.4	Equipment Under Test.....	6
1.5	Support Equipments.....	6
1.6	External I/O Cabling.....	7
1.7	E.U.T Operating Mode(s).....	7
1.8	Configuration.....	8
1.9	Calibration Details of Equipment Used for Measurement.....	9
1.10	Test Facility	9
1.11	Laboratory Accreditations and Listings	9
2.0	Test Regulations.....	10
2.1	Conducted Emissions at Mains Power Ports.....	12
2.2	Conducted Emissions at Telecommunication Ports	13
2.3	Radiated Electric Field Emissions(Below 1 GHz)	14
2.4	Radiated Electric Field Emissions(Above 1 GHz).....	15
2.5	Harmonic Current Emissions	16
2.6	Voltage Fluctuations and Flicker	17
3.0	Criteria for compliance.....	18
3.1	Electrostatic Discharge.....	20
3.2	Radiated Electric Field Immunity	24
3.3	Electrical Fast Transients/Bursts	27
3.4	Surge Transients.....	30
3.5	Conducted Disturbance.....	33
3.6	Voltage Dips and Short Interruptions.....	36
APPENDIX A – TEST DATA.....		38
Conducted Emissions at Mains Power Ports.....		38
Conducted Emissions at Telecommunication Ports		40
Radiated Electric Field Emissions(Below 1 GHz)		44
Radiated Electric Field Emissions(Above 1 GHz).....		45
Harmonic Current Emissions and Voltage Fluctuations and Flicker		53
Test Setup Photos and Configuration		56
Conducted Voltage Emissions		56
Conducted Telecommunication Emissions		57
Radiated Electric Field Emissions(Below 1 GHz)		59
Radiated Electric Field Emissions(Above 1 GHz).....		61
Harmonic Current Emissions and Voltage Fluctuations and Flicker		63
Electrostatic Discharge		64
Radiated Electric Field Immunity		65
Electrical Fast Transients/Bursts.....		66
Surge Transients.....		68
Conducted Disturbance.....		69
Voltage Dips and Short Interruptions.....		71
EUT External Photographs.....		72
EUT Internal Photographs		73

This report shall not be reproduced except in full, without the written approval of KES Co., Ltd.
The results shown in this test report refer only to the sample(s) tested unless otherwise stated.

1.0 General Product Description

Main Specifications of E.U.T are:

QND-7080R	
Video	
Imaging Device	1/3" 4M CMOS
Total Pixels	2720x1536
Effective Pixels	2688x1520
Scanning System	Progressive
Min. Illumination	Color : 0.15Lux, B/W : 0Lux
Lens	
Focal Length (Zoom Ratio)	Motorized 2.8~12mm
Max. Aperture Ratio	F1.4
Angular Field of View	H 109.7°~26.0° / V 60.8°~15.2° / D 131.3°~30.1°
Min. Object Distance	0.5m
Focus control	Simple focus(Motorized V/F) / Manual, Remote control via network
Lens Type	DC auto iris, P iris
Mount Type	Board type
Pan / Tilt / Rotate	
Pan Range	0~350°
Tilt Range	0~67°
Rotate Range	0~355°
Operational	
IR Viewable Length	20m
Camera Title	Off / On (Displayed up to 20 characters per line) - W/W : English/Numeric/Special Characters - China : English/Numeric/Special/Chinese Characters - Common : Multi-line (Max 5), Color (Grey/Green/Red/Blue/Black/White), Transparency, Auto Scale by Resolution
Day & Night	True Day & Night
Backlight Compensation	Off / BLC
Wide Dynamic Range	120dB
Digital Noise Reduction	SSNR(Off / On)
Motion Detection	Off / On (4ea polygon zones)
Privacy Masking	Off / On (6ea rectangular zones)
Gain Control	Off / Low / Middle / High
White Balance	ATW / AWC / Manual / Indoor / Outdoor
LDC(Lens distortion control)	On/Off (5 levels with Min/Max)
Electronic Shutter Speed	Minimum / Maximum / Anti flicker
Flip / Mirror	Flip / Mirror / Hallway view
Intelligent Video Analytics	Motion Detection with metadata, Tampering, Defocus
Alarm I/O	Input 1 / Output 1
Alarm Triggers	Motion detection, Tampering Detection, SD card error, NAS error, Alarm input, Defocus detection
Alarm Events	File upload via FTP and E-Mail Local storage recording at Event Notification via E-Mail External output
Pixel Counter	Support (plug-in viewer only)
Network	
Ethernet	RJ-45 (10/100BASE-T)
Video Compression Format	H.265, H.264, MJPEG
Resolution	2592x1520, 2560x1440(16:9) / 2304x1296 / 1920x1080 / 1280x1024 / 1280x960 / 1280x720 / 1024x768 / 800x600 / 800x450 / 720x576 / 720x480 / 640x480 / 640x380 / 320x240
Max. Framerate	H.265 : Max 20fps at 4M, Max 30fps at 2M all resolutions H.264 : Max 20fps at 4M, Max 30fps at 2M all resolutions MJPEG : Max 5fps

This report shall not be reproduced except in full, without the written approval of KES Co., Ltd.
The results shown in this test report refer only to the sample(s) tested unless otherwise stated.



KES Co., Ltd.

C-3701, Simin-daero 365-40,
 Dongan-gu, Anyang-si, Gyeonggi-do, 14057, Korea
 Tel: +82-31-425-6200 / Fax: +82-31-424-0450
 www.kes.co.kr

Test report No.:
 KES-E1-16T0336
 Page (5) of (8)

Smart codec	WiseStream
Video Quality Ajustment	H.265 : Target Bitrate Level Control H.264 : Target Bitrate Level Control MJPEG : Quality Level Control
Bitrate control method	H.265 : CBR or VBR H.264 : CBR or VBR MJPEG : VBR
Streaming Capability	Multiple Streaming(Up to 3 Profiles)
Audio I/O	Built-in MIC
Audio Compression Format	G.711 u-law /G.726 Selectable G.726(ADPCM) : 8KHz, G.711 : 8KHz G.726 : 16Kbps, 24Kbps, 32Kbps, 40Kbps
Audio Communication	Uni-directional
IP	IPv4, IPv6
Protocol	TCP/IP, UDP/IP, RTP(UDP), RTP(TCP), RTCP,RTSP, NTP, HTTP, HTTPS, SSL, DHCP, PPPoE, FTP, SMTP, ICMP, IGMP, SNMPv1/v2c/v3(MIB-2), ARP, DNS, DDNS, QoS, PIM-SM, UPnP, Bonjour
Security	HTTPS(SSL) Login Authentication Digest Login Authentication IP Address Filtering User access Log 802.1X Authentication
Streaming Method	Unicast / Multicast
Max. User Access	6 users at Unicast Mode
Edge storage	Micro SD/SDHC/SDXC Max 128G, NAS - Motion images recorded in the SD memory card can be downloaded - Manual recording at Local PC
Application Programming Inter	ONVIF Profile S, G SUNAPI(HTTP API)
Webpage Language	English, Korean, Chinese, French, Italian, Spanish, German, Japanese, Russian, Swedish, Portuguese, Czech, Polish, Turkish, Dutch, Hungary, Greek
Web Viewer	Supported OS: Windows 7, 8, 10, Mac OS X 10.8, 10.9, 10.10, 10.11 [Non-plugin Webviewer] Supported Browser: Google Chrome 47, MS Edge 20 Support Codec : Video-H.264, MJPEG (Max. 1M 15fps), Audio-G.711 [Plug-in Webviewer] Supported Browser : MS Explore 11 , Mozilla Firefox 43, Apple Safari 9 * Mac OS X only
Central Management Software	SmartViewer
Environmental	
Operating Temperature / Hum	-10°C ~ +55°C / Less than 90% RH
Storage Temperature / Humidi	-30°C ~ +60°C (-22°F ~ +140°F) / Less than 90% RH
Ingress Protection	-
Vandal Resistance	-
Electrical	
Input Voltage / Current	PoE(IEEE802.3af, Class3), DC 12V
Power Consumption	Max.7.2W(PoE), Max.6.4W(DC12V)
Mechanical	
Color / Material	Ivory / Plastic
Dimension (WxHxD)	φ119.8x98.8mm
Weight	355g

This report shall not be reproduced except in full, without the written approval of KES Co., Ltd.
 The results shown in this test report refer only to the sample(s) tested unless otherwise stated.



1.1 Test Voltage & Frequency

Unless indicated otherwise on the individual data sheet or test results, the test voltage and frequency was as indicated below.

Voltage 220 Vac 230 Vac 240 Vac PoE 12 Vdc
Frequency 50 Hz 60 Hz Hz

1.2 Variant Model Differences

Not applicable

1.3 Device Modifications

Not applicable

1.4 Equipment Under Test

Description	Model Number	Serial Number	Manufacturer	Remarks
NETWORK CAMERA	QND-7080RP	-	Tianjin Samsung Techwin Opto-Electronic Co., Ltd.	E.U.T

1.5 Support Equipments

Description	Model Number	Serial Number	Manufacturer	Remarks
Notebook	NT63025J	JK9091EF400432X	Samsung Electronics Co., Ltd.	-
AC/DC ADAPTER	A13-040N2A	CN60BA4400313AD 0N843KO243	Chicony Power Technology (suzhou)Co., Ltd.	-
PoE	ANY4805C-LT1	-	ANY ELECTRONICS CO., LTD.	-
Alarm	-	-	-	-

1.6 External I/O Cabling

- 12 V (dc) Mode

Start		END		Cable Spec.	
Description	I/O Port	Description	I/O Port	Length	Shield
NETWORK CAMERA (E.U.T)	LAN(RJ-45)	Notebook	LAN(RJ-45)	5.0	U
	Alarm	Alarm	Alarm	3.0	U

- PoE Mode

Start		END		Cable Spec.	
Description	I/O Port	Description	I/O Port	Length	Shield
NETWORK CAMERA (E.U.T)	LAN(PoE)	PoE	LAN(PoE)	5.0	U
	Alarm	Alarm	Alarm	3.0	U
PoE	LAN(RJ-45)	Notebook	LAN(RJ-45)	4.0	U

* Unshielded=U, Shielded=S

1.7 E.U.T Operating Mode(s)

Equipment under test was operated during the measurement under the following conditions:

Test mode	Normal operating
OP	MONITORING Network ping test

- Input power condition during the measurements was 12 V (dc) , PoE

1.8 Configuration

■ AC Main
□ DC Main

- 12 V (dc) Mode

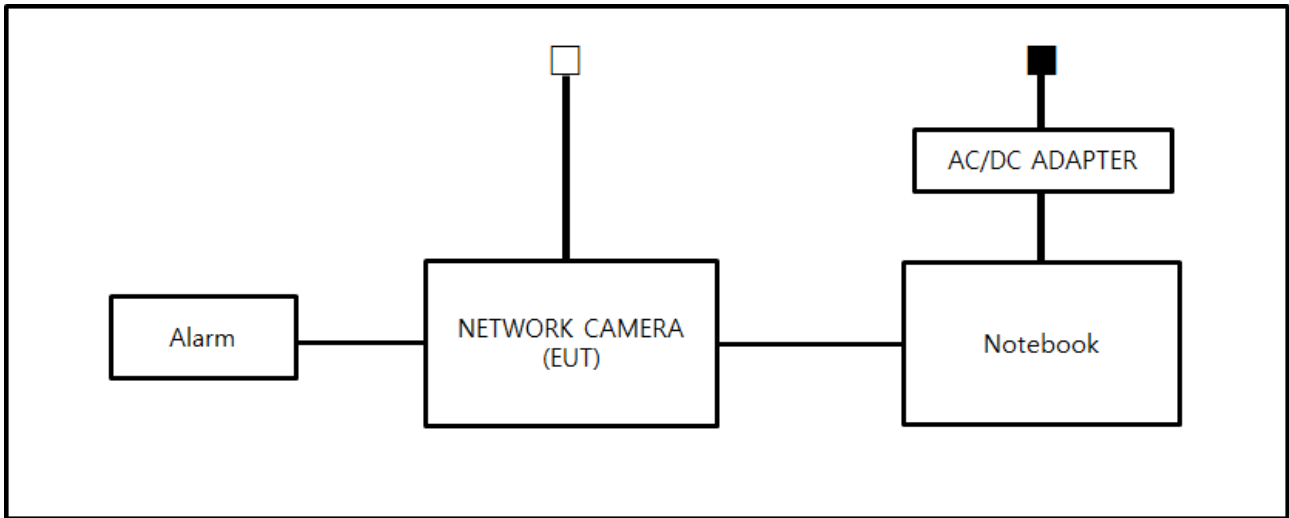

- PoE Mode

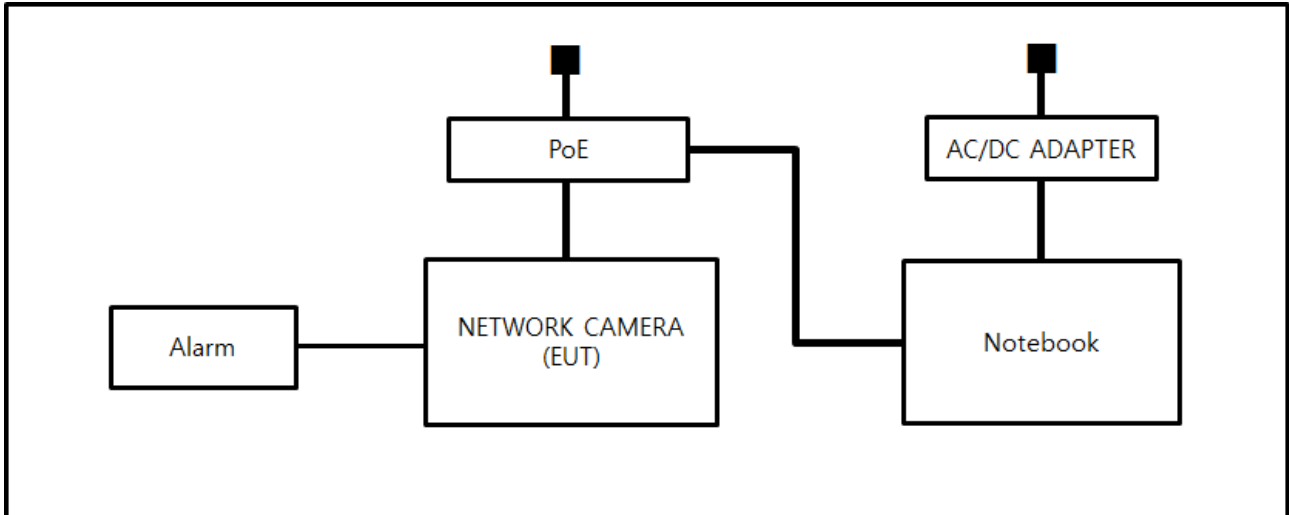

This report shall not be reproduced except in full, without the written approval of KES Co., Ltd.
The results shown in this test report refer only to the sample(s) tested unless otherwise stated.







1.9 Calibration Details of Equipment Used for Measurement

Test equipment and test accessories are calibrated on regular basis. The maximum time between calibrations is one year or what is recommended by the manufacturer, whichever is less.

1.10 Test Facility

The measurement facility is located at 473-29 Gayeo-ro, Yeosu-si, Gyeonggi-do, 12658, Korea. The sites are constructed in conformance with the requirements of ANSI C63.4 and CISPR Publication 22.

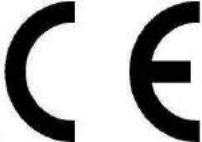
1.11 Laboratory Accreditations and Listings

Country	Agency	Scope of Accreditation	Logo
USA	FCC	3 & 10 meter Open Area Test Sites and one conducted site to perform FCC Part 15/18 measurements.	
JAPAN	VCCI	Mains Ports Conducted Interference Measurement, Telecommunication Ports Conducted Disturbance Measurement and Radiation 10 meter site, Facility for measuring radiated disturbance above 1 GHz	 R-4308, C-4798, T-2311, G-914
KOREA	MSIP	EMI (10 meter Open Area Test Site and two conducted sites) Radio(3 & 10 meter Open Area Test Sites and one conducted site) EMS (ESD, RS, EFT/Burst, Surge, CS, Magnetic, Dips and interruptions)	 KR0100
Canada	IC	3 & 10 meter Open Area Test Sites and one conducted site	 4769B-1
Europe	CE	EMI (10 meter Open Area Test Site and two conducted sites) Radio(3 & 10 meter Open Area Test Sites and one conducted site) EMS (ESD, RS, EFT/Burst, Surge, CS, Magnetic, Dips and interruptions)	
International	KOLAS	EMI (10 meter Open Area Test Site and two conducted sites) Radio(3 & 10 meter Open Area Test Sites and one conducted site) EMS (ESD, RS, EFT/Burst, Surge, CS, Magnetic, Dips and interruptions)	

2.0 Test Regulations

The emissions tests were performed according to following regulations:

EMC – Directive 2014/30/EU

EN 61000-6-3:2011

EN 61000-6-1:2007

EN 61000-6-4:2007 +A1:2011

EN 61000-6-2:2005

EN 55011:2007 +A1:2010

Group 1
 Class A

Group 2
 Class B

EN 55014-1:2006 +A2:2011

EN 55014-2:1997 +A2:2008

EN 55015:2013

EN 61547:2009

EN 55022:2010

Class A

Class B

EN 55024:2010 +A1:2015

EN 50130-4:2011 +A1:2014

EN 61000-3-2:2014

EN 61000-3-3:2013

EN 61326-1:2013



-
- | | | |
|---|----------------------------------|----------------------------------|
| <input type="checkbox"/> VCCI V-3 / 2015.04 | <input type="checkbox"/> Class A | <input type="checkbox"/> Class B |
| <input type="checkbox"/> AS/NZS CISPR22:2009 +A1:2010 | <input type="checkbox"/> Class A | <input type="checkbox"/> Class B |
| <input type="checkbox"/> 47 CFR Part 15, Subpart B | | |
| <input type="checkbox"/> CISPR 22:2009 +A1:2010 | <input type="checkbox"/> Class A | <input type="checkbox"/> Class B |
| <input type="checkbox"/> ANSI C63.4-2009 | | |
| <input type="checkbox"/> IC Regulation ICES-003 : 2016 | | |
| <input type="checkbox"/> CAN/CSA CISPR 22-10 | <input type="checkbox"/> Class A | <input type="checkbox"/> Class B |
| <input type="checkbox"/> ANSI C63.4-2014 | | |
|
 | | |
| <input type="checkbox"/> RE- Directive 2014/53/EU | | |
|
 | | |
| <input type="checkbox"/> EN 301 489-1 V1.9.2 | | |
| <input type="checkbox"/> Equipment for fixed use | | |
| <input type="checkbox"/> Equipment for vehicular use | | |
| <input type="checkbox"/> Equipment for portable use | | |
|
 | | |
| <input type="checkbox"/> EN 301 489-3 V1.6.1 | | |
| <input type="checkbox"/> EN 301 489-17 V2.2.1 | | |
| <input type="checkbox"/> EN 60945:2002 | | |

This report shall not be reproduced except in full, without the written approval of KES Co., Ltd.
The results shown in this test report refer only to the sample(s) tested unless otherwise stated.

2.1 Conducted Emissions at Mains Power Ports

Test Date

N/A

Test Location

Electro wave Shieldroom

Test Equipment

Used	Description	Model Number	Manufacturer	Serial Number	Cal. Due
<input type="checkbox"/>	EMI Test Receiver	ESR3	R&S	101783	05, 03, 2017
<input type="checkbox"/>	LISN	ENV216	R&S	101137	02, 04, 2017
<input type="checkbox"/>	LISN	ENV216	R&S	101786	05, 02, 2017
<input type="checkbox"/>	Electro wave Shieldroom	-	SEMITEC	-	-

Test ConditionsTemperature: °C
Relative Humidity: %**Frequency Range of Measurement**

150 kHz to 30 MHz

Instrument Settings

IF Band Width: 9 kHz

Test Results

The requirements are:

- PASS
 NOT PASS
 NOT APPLICABLE

Remarks

Because the E.U.T power is 12 V (dc) power and PoE, limits are not specified.

2.2 Conducted Emissions at Telecommunication Ports

Test Date

Jun. 28, 2016

Test Location

Electro wave Shieldroom

Test Equipment

Used	Description	Model Number	Manufacturer	Serial Number	Cal. Due
<input checked="" type="checkbox"/>	EMI Test Receiver	ESR3	R&S	101783	05, 03, 2017
<input checked="" type="checkbox"/>	LISN	ENV216	R&S	101137	02, 04, 2017
<input checked="" type="checkbox"/>	LISN	ENV216	R&S	101786	05, 02, 2017
<input checked="" type="checkbox"/>	8-Wire ISN CAT3	CAT3 8158	Schwarzbeck Mess	8158-0019	04, 01, 2017
<input checked="" type="checkbox"/>	8-Wire ISN CAT5	CAT5 8158	Schwarzbeck Mess	8158-0030	04, 01, 2017
<input type="checkbox"/>	8-Wire ISN CAT6	NTFM 8158	Schwarzbeck Mess	8158-0029	08, 14, 2016
<input checked="" type="checkbox"/>	Electro wave Shieldroom	-	SEMITEC	-	-

Test Conditions

Temperature: 24,5 °C

Relative Humidity: 47,7 %

Frequency Range of Measurement

150 kHz to 30 MHz

Instrument Settings

IF Band Width: 9 kHz

Test Results

The requirements are:

- PASS
- NOT PASS
- NOT APPLICABLE

Remarks

See Appendix A for test data.



2.3 Radiated Electric Field Emissions(Below 1 GHz)

Test Date

Jun. 27, 2016

Test Location

Open Area Test Site #1 Open Area Test Site #2

Test Equipment

Used	Description	Model Number	Manufacturer	Serial Number	Cal. Due
<input checked="" type="checkbox"/>	EMI Test Receiver	ESR3	R&S	101781	05, 03, 2017
<input checked="" type="checkbox"/>	Trilog-Broadband Antenna	VULB 9163	SCHWARZBECK	9163-713	05, 15, 2017
<input checked="" type="checkbox"/>	Open Area Test Site	-	KES	-	-
<input checked="" type="checkbox"/>	Antenna Mast	-	DAEIL EMC	-	-
<input checked="" type="checkbox"/>	Turn Table	-	DAEIL EMC	-	-

Test Conditions

Temperature: 30,5 °C
Relative Humidity: 43,0 %

Frequency Range of Measurement

30 MHz to 1 GHz

Instrument Settings

IF Band Width: 120 kHz

Test Results

The requirements are:

- PASS
 NOT PASS
 NOT APPLICABLE

Remarks

See Appendix A for test data.

2.4 Radiated Electric Field Emissions(Above 1 GHz)

Test Date

Jun. 28, 2016

Test Location

Semi Anchoic Chamber #2

Test Equipment

Used	Description	Model Number	Manufacturer	Serial Number	Cal. Due
<input checked="" type="checkbox"/>	EMI Test Receiver	ESU26	R&S	100552	04, 24, 2017
<input checked="" type="checkbox"/>	Broadband Coaxial Preampfier	BBV 9718	Schwarzbeck Mess - Elektronik	9718-246	10, 23, 2016
<input checked="" type="checkbox"/>	DOUBLE RIDGED HORN ANTENNA	SAS-571	A.H.SYSTEM,INC	781	05, 07, 2017
<input checked="" type="checkbox"/>	Semi Anchoic Chamber #2	-	SEMITEC	-	-
<input checked="" type="checkbox"/>	Antenna Mast	-	AUDIX	-	-
<input checked="" type="checkbox"/>	Turn Table	-	AUDIX	-	-

Test ConditionsTemperature: 24,5 °C
Relative Humidity: 47,7 %**Frequency Range of Measurement**

1 GHz to 6 GHz

Instrument Settings

IF Band Width: 1 MHz

Test Results

The requirements are:

- PASS
 NOT PASS
 NOT APPLICABLE

RemarksSee Appendix A for test data.



2.5 Harmonic Current Emissions

Test Date

N/A

Test Location

Electro wave Shieldroom

Test Equipment

Used	Description	Model Number	Manufacturer	Serial Number	Cal. Due
<input type="checkbox"/>	AC Source	ACS 500 N	EM TEST	V1024106760	08, 13, 2016
<input type="checkbox"/>	Digital Power Analyzer	DPA 500 N	EM TEST	V1024106759	08, 13, 2016

Test Conditions

Temperature: °C
Relative Humidity: %

Classification of Equipment for Harmonic Current Emissions

- Class A
- Class B
- Class C(Below 25 W)
- Class C(Above 25 W)
- Class D

Test Results

The requirements are:

- PASS
- NOT PASS
- NOT APPLICABLE

Remarks

Because the E.U.T power is less than 75 W, limits are not specified.



2.6 Voltage Fluctuations and Flicker

Test Date

N/A

Test Location

Electro wave Shieldroom

Test Equipment

Used	Description	Model Number	Manufacturer	Serial Number	Cal. Due
<input type="checkbox"/>	AC Source	ACS 500 N	EM test	V1024106760	08, 13, 2016
<input type="checkbox"/>	Digital Power Analyzer	DPA 500 N	EM test	V1024106759	08, 13, 2016

Test Conditions

Temperature: °C
Relative Humidity: %

Test Results

The requirements are:

- PASS
- NOT PASS
- NOT APPLICABLE

Remarks

Because the E.U.T power is 12 V (dc) power and PoE.

This report shall not be reproduced except in full, without the written approval of KES Co., Ltd.
The results shown in this test report refer only to the sample(s) tested unless otherwise stated.

3.0 Criteria for compliance

Criteria for compliance was based on the following guidelines:
EN 50130-4:2011 +A1:2014 Alarm systems-Part 4: Electromagnetic compatibility Product family standard: Immunity requirements for components of fire, intruder and social alarm systems

The variety and the diversity of the apparatus within the scope of this document makes it difficult to define precise criteria for the evaluation of the immunity test results.

If as a result of the application of the tests defined in this standard, the apparatus becomes dangerous or unsafe then the apparatus shall be deemed to have failed the test.

A functional description and a definition of performance by the manufacture and noted in the test report, based on the following criteria:

Electrostatic discharge

There shall be no damage, malfunction or change of status due to the conditioning.
Flickering of an indicator during the application of discharge is permissible, providing that is no residual change in the EUT or any change in outputs, which could be interpreted by associated equipment as a change.

Radiated electromagnetic fields

There shall be no damage, malfunction or change of status due to the conditioning.
Flickering of an indicator during the application of discharge is permissible, providing which could be interpreted by associated equipment as a change, and no such
Flickering of indicators occurs at a field strength of 3 V/m.
For components of CCTV systems, where the picture is allowed at 10 V/m, providing.
(a) there is no permanent damage or change to EUT
(e.g. no corruption of memory or changes to programmable setting etc.)
(b) at 3 V/m, any deterioration of the picture is so minor that the system could still be used; and
(c) there is no observable deterioration of the picture at 1 V/m.



Fast transient burst / slow high energy voltage surge

There shall be no damage, malfunction or change of status due to the conditioning.

Flickering of an indicator during the application of discharge is permissible, providing

That there is no residual is permissible, providing that there is no residual change in the EUT or any change in outputs, which could be interpreted by associated equipment as a change.

Conducted RF immunity

There shall be no damage, malfunction or change of status due to the conditioning.

Flickering of an indicator during the application of discharge is permissible, providing

That there is no residual is permissible, providing that there is no residual change in the EUT or any change in outputs, which could be interpreted by associated equipment as a change,
and no such flickering of indicators oeuvres at $U = 130 \text{ dB}\mu\text{V}$.

For component of CCTV systems, where the status is monitored by observing the TV picture,
then deterioration of the picture is allowed at $U = 140 \text{ dB}\mu\text{V}$, providing:

- (a) there is no permanent damage or change to the EUT
(e.g. no corruption of memory or changes to programmable settings etc.)
- (b) at $U = 130 \text{ dB}\mu\text{V}$, any deterioration of the picture is so minor that the system could still be used; and
- (c) there in no observable deterioration of the picture at $U = 120 \text{ dB}\mu\text{V}$.

Voltage dip/interruption / Voltage variation

There shall be no damage, malfunction or change of status due to the conditioning.

Flickering of an indicator during the conditioning is permissible, providing that there is no residual change in the EUT or any change in outputs, which could be interpreted by associated equipment as a change. The EUT shall meet the acceptance criteria for the functional test, after the conditioning.

3.1 Electrostatic Discharge

Reference Standard

EN 61000-4-2:2009

Test Date

Jun. 27, 2016

Test Location

EMS-ESD: Electro wave Shieldroom

Test Equipment

Used	Description	Model Number	Manufacturer	Serial Number	Cal. Due
<input checked="" type="checkbox"/>	ESD SIMULATOR	ESS-2000	Noise Ken	ESS05X4620	02, 24, 2017
<input checked="" type="checkbox"/>	HCP	-	Noise Ken	-	-
<input checked="" type="checkbox"/>	VCP	-	Noise Ken	-	-

Test Conditions

Temperature: 24,9 °C
Relative Humidity: 42,1 %
Atmospheric Pressure: 99,0 kPa

Test Specifications

Discharge Factor: ≥ 1 s

Discharge Impedance: 330 ohm / 150 pF

Kind of Discharge: Air, Contact (direct and indirect)

Polarity: Positive and Negative

Number of Discharge: 10 at all locations for Air discharge
10 at all locations for Contact discharge

Discharge Voltage:	Contact	Air	HCP	VCP
	<input type="checkbox"/> 2 kV	<input checked="" type="checkbox"/> 2 kV	<input type="checkbox"/> 2 kV	<input type="checkbox"/> 2 kV
	<input type="checkbox"/> 4 kV	<input checked="" type="checkbox"/> 4 kV	<input type="checkbox"/> 4 kV	<input type="checkbox"/> 4 kV
	<input checked="" type="checkbox"/> 6 kV	<input type="checkbox"/> 6 kV	<input checked="" type="checkbox"/> 6 kV	<input checked="" type="checkbox"/> 6 kV
	<input type="checkbox"/> 8 kV	<input checked="" type="checkbox"/> 8 kV	<input type="checkbox"/> 8 kV	<input type="checkbox"/> 8 kV
	<input type="checkbox"/> 15 kV	<input type="checkbox"/> 15 kV	<input type="checkbox"/> 15 kV	<input type="checkbox"/> 15 kV

Notes: HCP: Horizontal coupling plane
VCP: Vertical coupling plane

Required Performance Criteria: Complied

This report shall not be reproduced except in full, without the written approval of KES Co., Ltd.
The results shown in this test report refer only to the sample(s) tested unless otherwise stated.

Location of Discharge:

- 12 V (dc) Mode

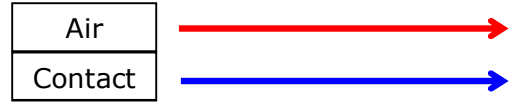

This report shall not be reproduced except in full, without the written approval of KES Co., Ltd.
The results shown in this test report refer only to the sample(s) tested unless otherwise stated.

- PoE Mode



This report shall not be reproduced except in full, without the written approval of KES Co., Ltd.
The results shown in this test report refer only to the sample(s) tested unless otherwise stated.



Test Data

- 12 V (dc) Mode

Indirect Discharge

No.	Test Point	Discharge Method	Performance	Remarks
			Observation	
1	HCP Contact	Contact Discharge	Complied	-
2	VCP Contact	Contact Discharge	Complied	-

Direct Discharge

No.	Test Point	Discharge Method	Performance	Remarks
			Observation	
1	Enclosure 1	Air Discharge	Complied	-
2	Enclosure 2	Air Discharge	Complied	-

- PoE Mode

Indirect Discharge

No.	Test Point	Discharge Method	Performance	Remarks
			Observation	
1	HCP Contact	Contact Discharge	Complied	-
2	VCP Contact	Contact Discharge	Complied	-

Direct Discharge

No.	Test Point	Discharge Method	Performance	Remarks
			Observation	
1	Enclosure 1	Air Discharge	Complied	-
2	Enclosure 2	Air Discharge	Complied	-

Note: "Blank" = Not performed

Observations:
Complied – No degradation of function

Test Results

- PASS Required Performance Criteria
- NOT PASS Required Performance Criteria

Remarks

PASS Required Performance Criteria.

3.2 Radiated Electric Field Immunity

Reference Standard

EN 61000-4-3:2006 +A2:2010

Test Date

Jun. 29, 2016

Test Location

EMS-RS: Semi Anchoic Chamber #1 Semi Anchoic Chamber #2

Test Equipment

Used	Description	Model Number	Manufacturer	Serial Number	Cal. Due
<input checked="" type="checkbox"/>	SIGNAL GENERATOR	SMB 100A	R&S	108252	08, 13, 2016
<input checked="" type="checkbox"/>	BROADBAND AMPLIFIER	BBA100	R&S	101239	08, 13, 2016
<input checked="" type="checkbox"/>	BROADBAND AMPLIFIER	100S1G6M1	AR	579931	08, 13, 2016
<input checked="" type="checkbox"/>	POWER METER	NRP2	R&S	103475	08, 13, 2016
<input checked="" type="checkbox"/>	AVG POWER SENSOR	NRP-Z91	R&S	102526	08, 13, 2016
<input checked="" type="checkbox"/>	AVG POWER SENSOR	NRP-Z91	R&S	102527	08, 13, 2016
<input checked="" type="checkbox"/>	Stacked Log.-Per.Antenna	STLP 9128 D	Schwarzbeck	9128D038	-
<input checked="" type="checkbox"/>	DIRECTIONAL COUPLER	KYDC-D1070-DX40	KyTelecom Co., Ltd.	KY150001	09, 25, 2016
<input checked="" type="checkbox"/>	Semi Anchoic Chamber #2		SEMITEC	-	-

This report shall not be reproduced except in full, without the written approval of KES Co., Ltd.
The results shown in this test report refer only to the sample(s) tested unless otherwise stated.

Test Conditions

Temperature: 23,8 °C
Relative Humidity: 49,2 %
Atmospheric Pressure: 99,0 kPa

Test Specifications

Antenna Polarization: Horizontal & vertical unless indicated otherwise

Antenna Distance: 3 m

Field Strength: 1 V/m 3 V/m
 10 V/m

Frequency Range: 80 MHz to 1 GHz 1,4 GHz to 2,7 GHz
 80 MHz to 2,7 GHz

Modulation: AM, 80 %, 1 kHz sine wave
 PM, 1 Hz (0,5 s ON : 0,5 s OFF)

Frequency step: 1 % step

Dwell Time: 1 s 3 s

of Sides Radiated: 4

Required Performance Criteria: Complied

Test Data

- 12 V (dc) Mode

Side Exposed	Observation	
	Horizontal	Vertical
Front	Complied	Complied
Right	Complied	Complied
Back	Complied	Complied
Left	Complied	Complied



KES Co., Ltd.

C-3701, Simin-daero 365-40,
Dongan-gu, Anyang-si, Gyeonggi-do, 14057, Korea
Tel: +82-31-425-6200 / Fax: +82-31-424-0450
www.kes.co.kr

Test report No.:
KES-E1-16T0336
Page (26) of (78)

- PoE Mode

Side Exposed	Observation	
	Horizontal	Vertical
Front	Complied	Complied
Right	Complied	Complied
Back	Complied	Complied
Left	Complied	Complied

Note: "Blank" = Not performed

Observations:
Complied – No degradation of function

Test Results

- PASS Required Performance Criteria
- NOT PASS Required Performance Criteria

Remarks

PASS Required Performance Criteria.

This report shall not be reproduced except in full, without the written approval of KES Co., Ltd.
The results shown in this test report refer only to the sample(s) tested unless otherwise stated.

3.3 Electrical Fast Transients/Bursts

Reference Standard

EN 61000-4-4:2012

Test Date

Jun. 29, 2016

Test Location

EMS-EFT: Electro wave Shieldroom

Test Equipment

Used	Description	Model Number	Manufacturer	Serial Number	Cal. Due
<input checked="" type="checkbox"/>	Ultra Compact Simulator	UCS 500 N5	EM TEST	V0936105120	06, 27, 2017
<input checked="" type="checkbox"/>	Capacitive Coupling Clamp	HFK	EM TEST	070925	06, 27, 2017
<input checked="" type="checkbox"/>	Motor Variac	MV2616	EM TEST	V0936105123	06, 27, 2017

Test Conditions

Temperature: 23,9 °C
Relative Humidity: 49,4 %
Atmospheric Pressure: 99,0 kPa

Test Specifications

Pulse Amplitude & Polarity:
(AC Power Lines) ± 1.0 kV ± 2.0 kV
 ± 4.0 kV

Pulse Amplitude & Polarity:
(Other supply / Signal Lines) ± 0.5 kV ± 1.0 kV
 ± 2.0 kV

Burst Period: 300 ms 2 s

Repetition Rate: 5 klz 100 klz

Duration of Test Voltage: ≥ 1 min

Required Performance Criteria: Complied

This report shall not be reproduced except in full, without the written approval of KES Co., Ltd.
The results shown in this test report refer only to the sample(s) tested unless otherwise stated.



Test Data

- 12 V (dc) Mode

Input a.c. power ports – Coupling/Decoupling Network used

Mode of Application	OBSERVATIONS	
	(+) Burst (kV)	(-) Burst (kV)
-	-	-

Input d.c. power ports – Coupling/Decoupling Network used

Mode of Application	OBSERVATIONS	
	(+) Burst (kV)	(-) Burst (kV)
L1 – L2	Complied	Complied

Signal ports and telecommunication ports – Coupling Clamp used

Mode of Application	OBSERVATIONS	
	(+) Burst (kV)	(-) Burst (kV)
LAN(RJ-45)	Complied	Complied
Alarm	Complied	Complied

This report shall not be reproduced except in full, without the written approval of KES Co., Ltd.
The results shown in this test report refer only to the sample(s) tested unless otherwise stated.



- PoE Mode

Input a.c. power ports – Coupling/Decoupling Network used

Mode of Application	OBSERVATIONS	
	(+) Burst (kV)	(-) Burst (kV)
-	-	-

Input d.c. power ports – Coupling/Decoupling Network used

Mode of Application	OBSERVATIONS	
	(+) Burst (kV)	(-) Burst (kV)
-	-	-

Signal ports and telecommunication ports – Coupling Clamp used

Mode of Application	OBSERVATIONS	
	(+) Burst (kV)	(-) Burst (kV)
LAN(PoE)	Complied	Complied
Alarm	Complied	Complied

Note: “Blank” = Not performed

Observations:
Complied – No degradation of function

Test Results

- PASS Required Performance Criteria
- NOT PASS Required Performance Criteria

Remarks

PASS Required Performance Criteria.

3.4 Surge Transients

Reference Standard

EN 61000-4-5:2014

Test Date

Jun. 30, 2016

Test Location

EMS-Surge: Electro wave Shieldroom

Test Equipment

Used	Description	Model Number	Manufacturer	Serial Number	Cal. Due
<input checked="" type="checkbox"/>	Ultra Compact Simulator	UCS 500 N5	EM TEST	V0936105120	06, 27, 2017
<input checked="" type="checkbox"/>	Motor Variac	MV2616	EM TEST	V0936105123	06, 27, 2017
<input type="checkbox"/>	CDN	CNV 504N	EM TEST	V0936105121	03, 25, 2017
<input checked="" type="checkbox"/>	CDN	CNV 508N1	EM TEST	P1551168979	04, 27, 2017
<input type="checkbox"/>	CDN	CNV 508T5	EM TEST	P1549168422	04, 27, 2017

Test Conditions

Temperature: 23,9 °C
Relative Humidity: 49,4 %
Atmospheric Pressure: 99,0 kPa

Test Specifications

AC Power Lines

Source Impedance: 12 ohm for common mode and 2 ohm for differential mode

Surge Amplitude : Common Mode
 (0,5 / 1,0 / 2,0) kV
Differential Mode
 (0,5 / 1,0) kV

Number of Surges: 5 surges per angle

Angle: 0°, 90°, 180°, 270° (input a.c. power port)

Polarity: Positive & Negative

Repetition Rate: 1 surge per min 1 surge per 30 sec.

Required Performance Criteria: Complied



Other supply / Signal Lines

Source Impedance: 42 ohm for common mode
Surge Amplitude: Common Mode
 (0,5 / 1,0) kV

Number of Surges: 5 Surges

Polarity: Positive & Negative

Repetition Rate: 1 surge per min 1 surge per 30 sec.

Required Performance Criteria: Complied

Test Data

- 12 V (dc) Mode

Line to Line – Differential Mode

Mode of Application	OBSERVATIONS	
	(+) Surge (kV)	(-) Surge (kV)
-	-	-

Line to Earth – Common Mode

Mode of Application	OBSERVATIONS	
	(+) Surge (kV)	(-) Surge (kV)
-	-	-

Signal Lines

Line to Earth – Common Mode

Mode of Application	OBSERVATIONS	
	(+) Surge (kV)	(-) Surge (kV)
LAN(RJ-45)	Complied	Complied
Alarm	Complied	Complied



- PoE Mode

Line to Line – Differential Mode

Mode of Application	OBSERVATIONS	
	(+) Surge (kV)	(-) Surge (kV)
-	-	-

Line to Earth – Common Mode

Mode of Application	OBSERVATIONS	
	(+) Surge (kV)	(-) Surge (kV)
-	-	-

Signal Lines

Line to Earth – Common Mode

Mode of Application	OBSERVATIONS	
	(+) Surge (kV)	(-) Surge (kV)
LAN(PoE)	Complied	Complied
Alarm	Complied	Complied

Note: "Blank" = Not performed

Observations:
Complied – No degradation of function

Test Results

- PASS Required Performance Criteria
- NOT PASS Required Performance Criteria

Remarks

PASS Required Performance Criteria.

3.5 Conducted Disturbance

Reference Standard

EN 61000-4-6:2014

Test Date

Jul. 01, 2016

Test Location

EMS-CS: Electro wave Shieldroom

Test Equipment

Used	Description	Model Number	Manufacturer	Serial Number	Cal. Due
<input checked="" type="checkbox"/>	Continuous Wave Generator	CWS 500N1	EM TEST	V0936105119	09, 25, 2016
<input checked="" type="checkbox"/>	6dB Attenuator	ATT6	EM TEST	1208-34	08, 13, 2016
<input checked="" type="checkbox"/>	CDN	CDN-M2/M3N	EM TEST	0909-06	08, 13, 2016
<input type="checkbox"/>	CDN	CDN-T2-RJ11	EM TEST	0909-07	08, 13, 2016
<input type="checkbox"/>	CDN	CDN-T4	EM TEST	0909-08	08, 13, 2016
<input type="checkbox"/>	CDN	CDN-T8RJ45	EM TEST	0909-09	08, 13, 2016
<input type="checkbox"/>	CDN	CDN-AF2	EM TEST	0909-10	08, 13, 2016
<input type="checkbox"/>	CDN	CDN-AF4	EM TEST	0909-11	08, 13, 2016
<input checked="" type="checkbox"/>	EM Injection Clamp	EM 101	Liithi	35943	02, 04, 2017

Test Conditions

Temperature: 23,7 °C
Relative Humidity: 53,4 %
Atmospheric Pressure: 99,7 kPa



Test Specifications

- Frequency range: 150 kHz to 100 MHz 150 kHz to 80 MHz
- Voltage Level: 1 Vrms 3 Vrms
 10 Vrms
- Modulation: AM, 80 %, 1 kHz sine wave
 PM, 1 Hz (0,5 s ON : 0,5 s OFF)
- Frequency step: 1 % step
- Dwell Time: 1 s 3 s
- Required Performance Criteria: Complied

Test Data

- 12 V (dc) Mode

Input a.c. power ports

Coupling Location (Line Stressed)	Coupling Method	Observation
-	CDN (<input type="checkbox"/> M2, <input type="checkbox"/> M3)	-

Input d.c. power ports

Coupling Location (Line Stressed)	Coupling Method	Observation
L1 - L2	CDN (<input checked="" type="checkbox"/> M2, <input type="checkbox"/> M3)	Complied

Signal ports and telecommunication ports

Coupling Location (Line Stressed)	Coupling Method	Observation
LAN(RJ-45)	EM Injection Clamp	Complied
Alarm	EM Injection Clamp	Complied

- PoE Mode

Input a.c. power ports

Coupling Location (Line Stressed)	Coupling Method	Observation
-	CDN (<input type="checkbox"/> M2, <input type="checkbox"/> M3)	-

Input d.c. power ports

Coupling Location (Line Stressed)	Coupling Method	Observation
-	CDN (<input type="checkbox"/> M2, <input type="checkbox"/> M3)	-

Signal ports and telecommunication ports

Coupling Location (Line Stressed)	Coupling Method	Observation
LAN(PoE)	EM Injection Clamp	Complied
Alarm	EM Injection Clamp	Complied

Notes: CDN = Coupling Decoupling Network
"blank" = Not performed

Observations:

Complied – No degradation of function

Test Results

- PASS Required Performance Criteria
- NOT PASS Required Performance Criteria

Remarks

PASS Required Performance Criteria.



3.6 Voltage Dips and Short Interruptions

Reference Standard

EN 61000-4-11:2004

Test Date

N/A

Test Location

EMS-Voltage dip: Electro wave Shieldroom

Test Equipment

Used	Description	Model Number	Manufacturer	Serial Number	Cal. Due
<input type="checkbox"/>	Ultra Compact Simulator	UCS 500 N5	EM TEST	V0936105120	06, 27, 2017
<input type="checkbox"/>	Motor Variac	MV2616	EM TEST	V0936105123	06, 27, 2017

Test Conditions

Temperature: °C
Relative Humidity: %
Atmospheric Pressure: kPa

This report shall not be reproduced except in full, without the written approval of KES Co., Ltd.
The results shown in this test report refer only to the sample(s) tested unless otherwise stated.



Test Specifications & Observations/Remarks

<u>Test Level</u>	<u>Duration [in period/ms (50 Hz)]</u>	<u>Results</u>
<input type="checkbox"/> 20 % dip	<input type="checkbox"/> 250 /10	_____
<input type="checkbox"/> 30 % dip	<input type="checkbox"/> 25 /10	_____
<input type="checkbox"/> 60 % dip	<input type="checkbox"/> 10 /10	_____
<input type="checkbox"/> 100 % dip	<input type="checkbox"/> 250 /10	_____

- Voltage variations

<input type="checkbox"/> Unom + 10 %	<input type="checkbox"/> 253 V (ac)	_____
<input type="checkbox"/> Unom - 15 %	<input type="checkbox"/> 195.5 V (ac)	_____

Observations:

Complied – No degradation of function

Test Results

- PASS Required Performance Criteria
- NOT PASS Required Performance Criteria
- NOT APPLICABLE

Remarks

NOT APPLICABLE



KES Co., Ltd.

C-3701, Simin-daero 365-40,
Dongan-gu, Anyang-si, Gyeonggi-do, 14057, Korea
Tel: +82-31-425-6200 / Fax: +82-31-424-0450
www.kes.co.kr

Test report No.:
KES-E1-16T0336
Page (38) of (78)

APPENDIX A – TEST DATA

Conducted Emissions at Mains Power Ports

[HOT]

N/A

This report shall not be reproduced except in full, without the written approval of KES Co., Ltd.
The results shown in this test report refer only to the sample(s) tested unless otherwise stated.



KES Co., Ltd.

C-3701, Simin-daero 365-40,
Dongan-gu, Anyang-si, Gyeonggi-do, 14057, Korea
Tel: +82-31-425-6200 / Fax: +82-31-424-0450
www.kes.co.kr

Test report No.:
KES-E1-16T0336
Page (39) of (78)

[NEUTRAL]

N/A

This report shall not be reproduced except in full, without the written approval of KES Co., Ltd.
The results shown in this test report refer only to the sample(s) tested unless otherwise stated.

Conducted Emissions at Telecommunication Ports

- 12 V (dc) Mode

[10 Mbps]

Common Information

Test Description:	Telecommunication Emission
Model No.:	QND-7080RP
Mode	12 V (dc) , 10 Mbps
Operator Name:	KES

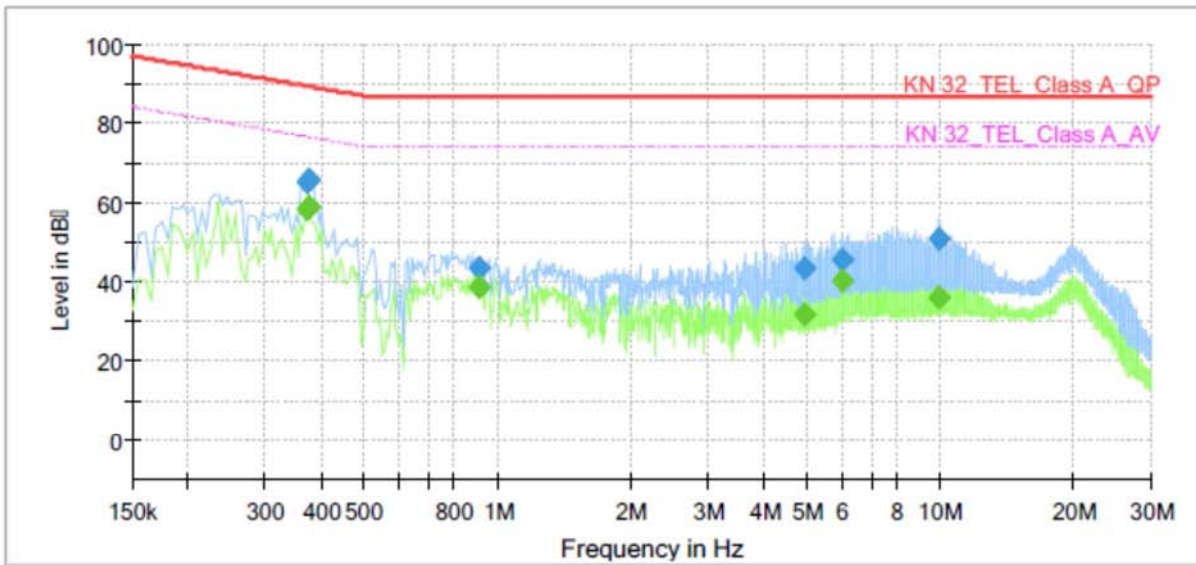

Final Result

Frequency (MHz)	QuasiPeak (dBμ)	CAverage (dBμ)	Limit (dBμ)	Margin (dB)	Meas. Time (ms)	Bandwidth (kHz)	Line	Corr. (dB)
0.370000	---	58.41	76.50	18.09	1000.0	9.000	Single Line	10.0
0.370000	65.05	---	89.50	24.45	1000.0	9.000	Single Line	10.0
0.375000	---	58.50	76.39	17.89	1000.0	9.000	Single Line	10.0
0.375000	65.51	---	89.39	23.88	1000.0	9.000	Single Line	10.0
0.905000	---	38.76	74.00	35.24	1000.0	9.000	Single Line	9.9
0.905000	43.37	---	87.00	43.63	1000.0	9.000	Single Line	9.9
4.935000	---	31.88	74.00	42.12	1000.0	9.000	Single Line	9.9
4.935000	43.39	---	87.00	43.61	1000.0	9.000	Single Line	9.9
6.050000	---	40.07	74.00	33.93	1000.0	9.000	Single Line	9.9
6.050000	45.65	---	87.00	41.35	1000.0	9.000	Single Line	9.9
10.005000	---	35.87	74.00	38.13	1000.0	9.000	Single Line	10.1
10.005000	50.91	---	87.00	36.09	1000.0	9.000	Single Line	10.1

This report shall not be reproduced except in full, without the written approval of KES Co., Ltd.
The results shown in this test report refer only to the sample(s) tested unless otherwise stated.

[100 Mbps]

Common Information

Test Description:	Telecommunication Emission
Model No.:	QND-7080RP
Mode	12 V (dc) , 100 Mbps
Operator Name:	KES

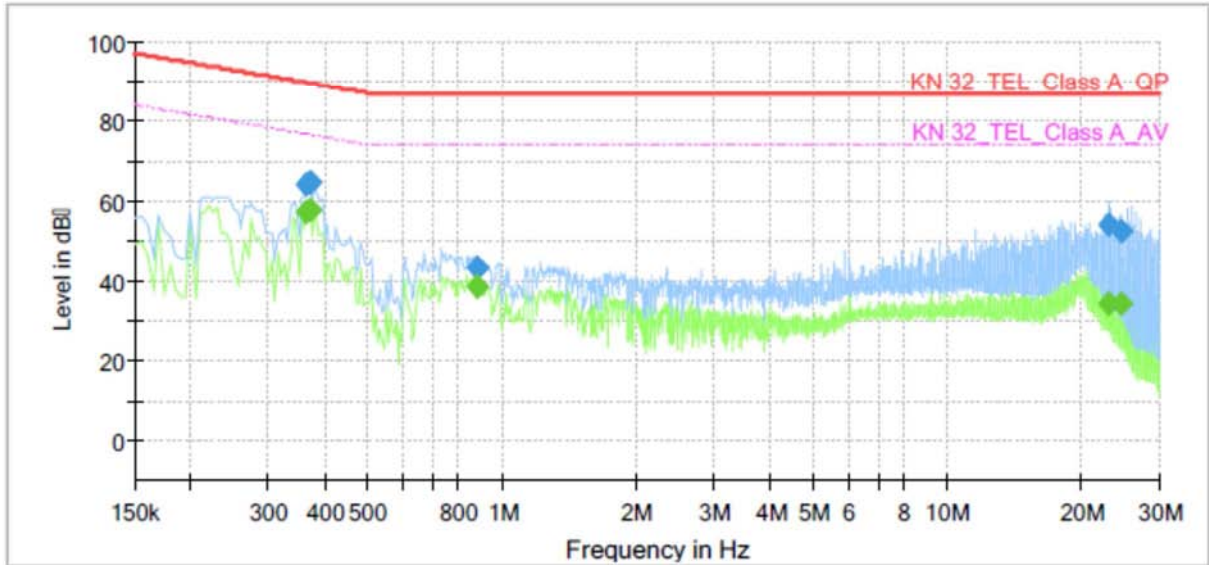

Final_Result

Frequency (MHz)	QuasiPeak (dB μ V)	CAverage (dB μ V)	Limit (dB μ V)	Margin (dB)	Meas. Time (ms)	Bandwidth (kHz)	Line	Corr. (dB)
0.365000	---	57.36	76.61	19.25	1000.0	9.000	Single Line	9.5
0.365000	63.81	---	89.61	25.80	1000.0	9.000	Single Line	9.5
0.370000	---	57.69	76.50	18.81	1000.0	9.000	Single Line	9.5
0.370000	64.36	---	89.50	25.14	1000.0	9.000	Single Line	9.5
0.885000	---	38.78	74.00	35.22	1000.0	9.000	Single Line	9.4
0.885000	43.38	---	87.00	43.62	1000.0	9.000	Single Line	9.4
23.130000	---	34.28	74.00	39.72	1000.0	9.000	Single Line	9.5
23.130000	53.90	---	87.00	33.10	1000.0	9.000	Single Line	9.5
24.550000	---	34.19	74.00	39.81	1000.0	9.000	Single Line	9.4
24.550000	52.27	---	87.00	34.73	1000.0	9.000	Single Line	9.4

This report shall not be reproduced except in full, without the written approval of KES Co., Ltd.
The results shown in this test report refer only to the sample(s) tested unless otherwise stated.

- PoE Mode

[10 Mbps]

Common Information

Test Description:	Telecommunication Emission
Model No.:	QND-7080RP
Mode	PoE , 10 Mbps
Operator Name:	KES

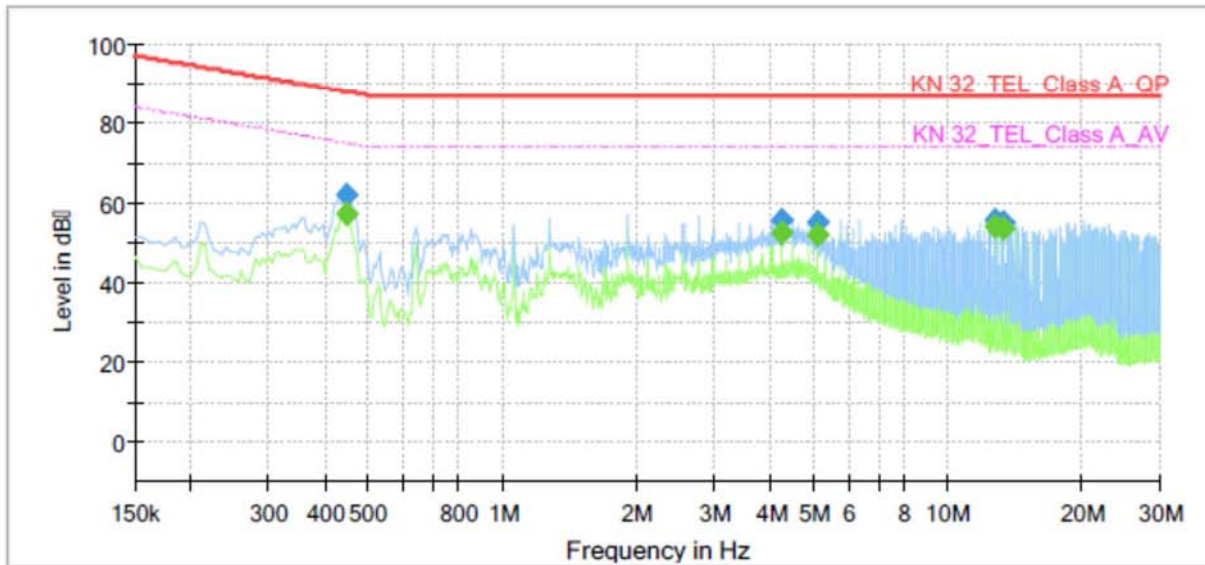

Final Result

Frequency (MHz)	QuasiPeak (dB μ V)	CAverage (dB μ V)	Limit (dB μ V)	Margin (dB)	Meas. Time (ms)	Bandwidth (kHz)	Line	Corr. (dB)
0.445000	---	57.24	74.97	17.73	1000.0	9.000	Single Line	10.0
0.445000	61.90	---	87.97	26.07	1000.0	9.000	Single Line	10.0
4.255000	---	52.34	74.00	21.66	1000.0	9.000	Single Line	9.8
4.255000	55.61	---	87.00	31.39	1000.0	9.000	Single Line	9.8
5.105000	---	52.05	74.00	21.95	1000.0	9.000	Single Line	9.9
5.105000	55.31	---	87.00	31.69	1000.0	9.000	Single Line	9.9
12.760000	---	53.95	74.00	20.05	1000.0	9.000	Single Line	10.1
12.760000	55.43	---	87.00	31.57	1000.0	9.000	Single Line	10.1
13.400000	---	53.70	74.00	20.30	1000.0	9.000	Single Line	10.1
13.400000	55.05	---	87.00	31.95	1000.0	9.000	Single Line	10.1

This report shall not be reproduced except in full, without the written approval of KES Co., Ltd.
The results shown in this test report refer only to the sample(s) tested unless otherwise stated.

[100 Mbps]

Common Information

Test Description:	Telecommunication Emission
Model No.:	QND-7080RP
Mode	PoE , 100 Mbps
Operator Name:	KES

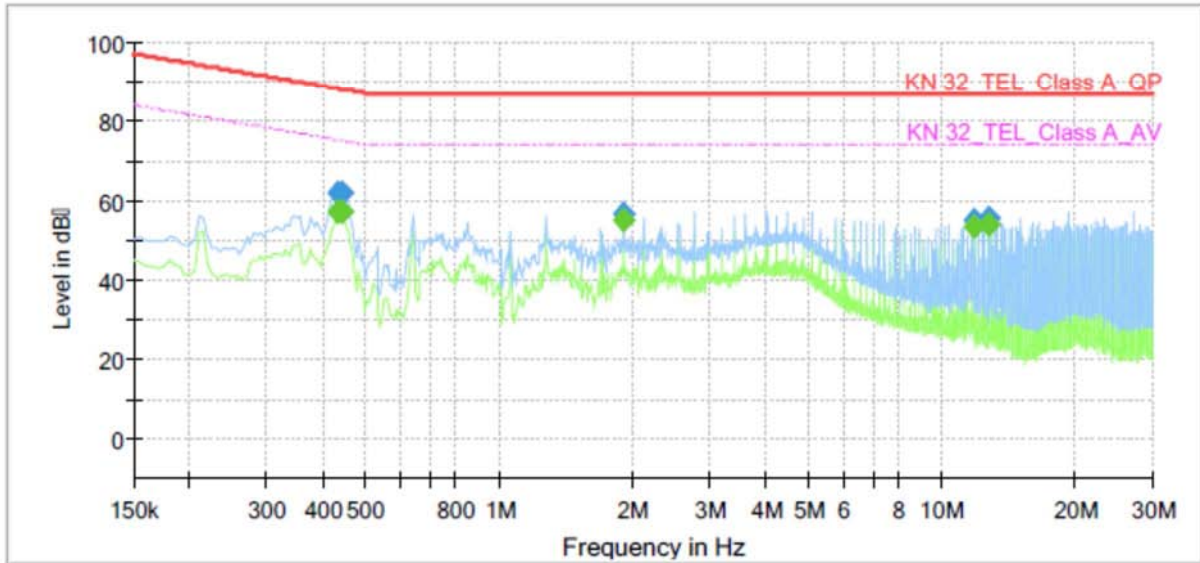

Final Result

Frequency (MHz)	QuasiPeak (dBμV)	CAverage (dBμV)	Limit (dBμV)	Margin (dB)	Meas. Time (ms)	Bandwidth (kHz)	Line	Corr. (dB)
0.435000	---	57.12	75.16	18.04	1000.0	9.000	Single Line	9.5
0.435000	61.81	---	88.16	26.35	1000.0	9.000	Single Line	9.5
0.440000	---	57.34	75.06	17.72	1000.0	9.000	Single Line	9.5
0.440000	61.93	---	88.06	26.13	1000.0	9.000	Single Line	9.5
1.915000	---	54.80	74.00	19.20	1000.0	9.000	Single Line	9.3
1.915000	56.80	---	87.00	30.20	1000.0	9.000	Single Line	9.3
11.910000	---	53.26	74.00	20.74	1000.0	9.000	Single Line	9.6
11.910000	54.96	---	87.00	32.04	1000.0	9.000	Single Line	9.6
12.760000	---	53.82	74.00	20.18	1000.0	9.000	Single Line	9.6
12.760000	55.50	---	87.00	31.50	1000.0	9.000	Single Line	9.6

This report shall not be reproduced except in full, without the written approval of KES Co., Ltd.
The results shown in this test report refer only to the sample(s) tested unless otherwise stated.



Radiated Electric Field Emissions(Below 1 GHz)

- 12 V (dc) Mode

Frequency [MHz]	Amplitude [dB μ V]	ANT Polar. (H/V)	ANT. Height [m]	Correction Factor		Corrected Amplitude [dB μ V/m]	Applicable Limit [dB μ V/m]	Margin [dB]
				ANT. [dB/m]	Cable [dB]			
148.51	12.84	V	1.05	8.15	2.76	23.75	40.00	16.25
216.01	8.91	H	4.00	11.66	3.44	24.01	40.00	15.99
375.00	13.46	H	3.86	15.12	4.85	33.43	47.00	13.57
455.99	14.51	V	1.00	16.48	5.44	36.43	47.00	10.57
456.00	8.14	H	3.91	16.48	5.44	30.06	47.00	16.94
504.00	11.02	V	1.00	17.19	5.77	33.98	47.00	13.02
504.02	7.31	H	3.45	17.19	5.77	30.27	47.00	16.73

* H : Horizontal, V : Vertical

- PoE Mode

Frequency [MHz]	Amplitude [dB μ V]	ANT Polar. (H/V)	ANT. Height [m]	Correction Factor		Corrected Amplitude [dB μ V/m]	Applicable Limit [dB μ V/m]	Margin [dB]
				ANT. [dB/m]	Cable [dB]			
49.01	11.18	V	1.03	13.90	1.44	26.52	40.00	13.48
148.51	11.25	V	1.10	8.15	2.76	22.16	40.00	17.84
216.00	8.70	H	4.00	11.66	3.44	23.80	40.00	16.20
374.99	13.02	H	3.79	15.12	4.85	32.99	47.00	14.01
456.00	8.42	H	3.84	16.48	5.44	30.34	47.00	16.66
456.00	14.59	V	1.00	16.48	5.44	36.51	47.00	10.49
503.99	9.53	V	1.00	17.19	5.77	32.49	47.00	14.51
504.01	7.90	H	3.38	17.19	5.77	30.86	47.00	16.14

* H : Horizontal, V : Vertical



Radiated Electric Field Emissions(Above 1 GHz)

- 12 V (dc) Mode

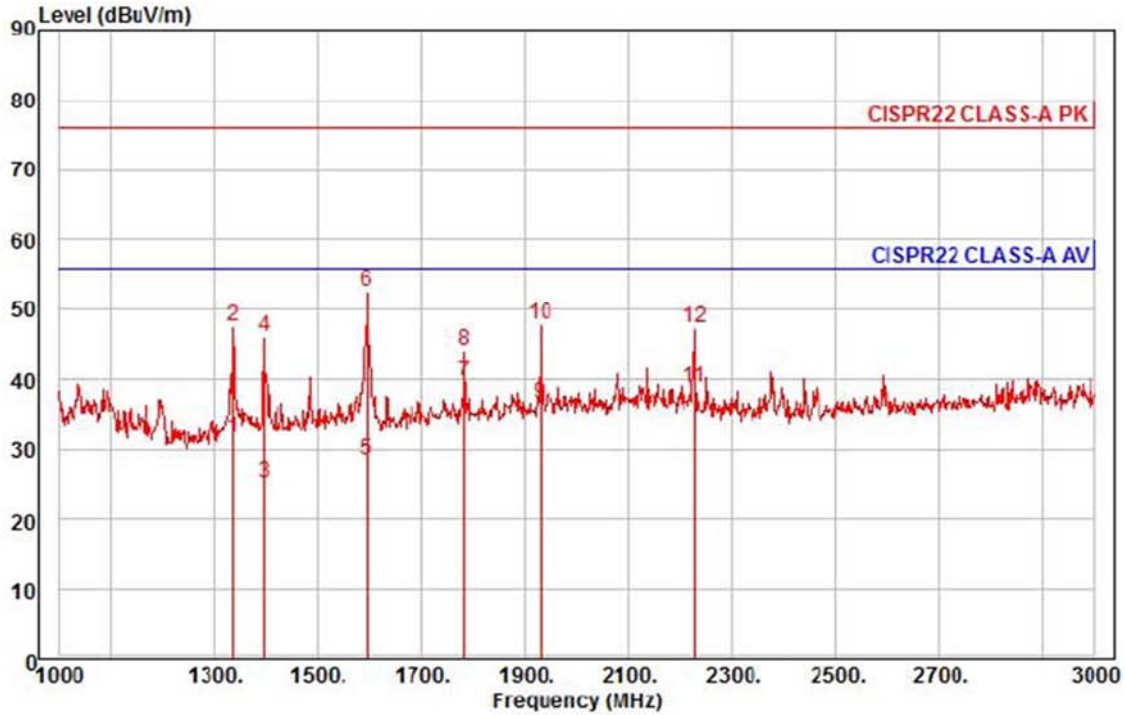

Site : chamber
Condition: CISPR22 CLASS-A PK 3m HORN781(2015.05.07) horizontal
: RBW:1000.000kHz VBW:1000.000kHz SWT:Auto
Project : NETWORK CAMERA
Model : QND-7080RP
Mode : 12 V (dc)
Memo : (1 - 3) GHz

	Read Freq	Ant Level	Ant Factor	Cable Loss	Preamp Factor	TPos	Limit Line	Over Limit	Pol/Phase	Remark
	MHz	dBuV	dB/m	dB	dB	deg	dBuV/m	dB		
1	1336.00	38.76	25.24	7.48	39.96	336	56.00	-24.48	horizontal	Average
2	1336.00	54.87	25.24	7.48	39.96	336	76.00	-28.37	horizontal	Peak
3	1396.00	31.93	25.48	7.66	39.93	111	56.00	-30.86	horizontal	Average
4	1396.00	52.92	25.48	7.66	39.93	111	76.00	-29.87	horizontal	Peak
5	1596.00	33.70	26.28	8.24	39.83	88	56.00	-27.61	horizontal	Average
6 pk	1596.00	58.14	26.28	8.24	39.83	88	76.00	-23.17	horizontal	Peak
7 pp	1782.00	43.66	27.01	8.75	39.74	33	56.00	-16.32	horizontal	Average
8	1782.00	48.07	27.01	8.75	39.74	33	76.00	-31.91	horizontal	Peak
9	1930.00	39.38	27.60	9.16	39.66	5	56.00	-19.52	horizontal	Average
10	1930.00	50.66	27.60	9.16	39.66	5	76.00	-28.24	horizontal	Peak
11	2228.00	40.46	28.44	9.70	39.76	356	56.00	-17.16	horizontal	Average
12	2228.00	48.93	28.44	9.70	39.76	356	76.00	-28.69	horizontal	Peak

This report shall not be reproduced except in full, without the written approval of KES Co., Ltd.
The results shown in this test report refer only to the sample(s) tested unless otherwise stated.

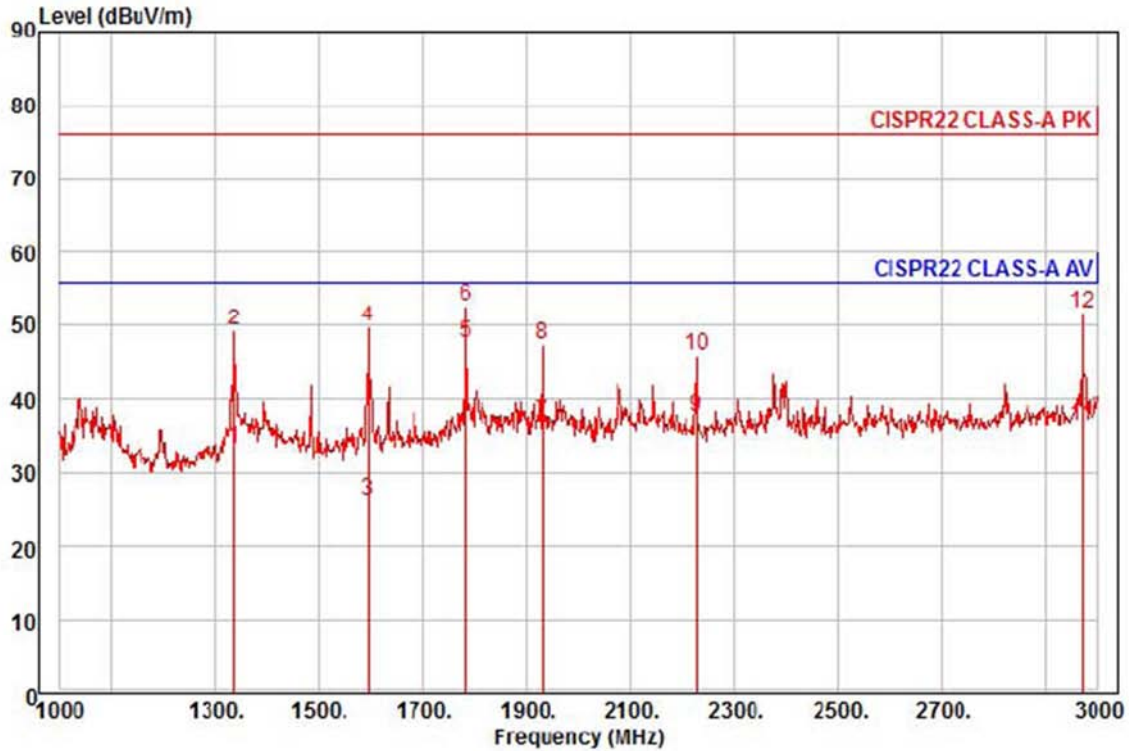

Site : chamber
 Condition: CISPR22 CLASS-A PK 3m HORN781(2015.05.07) vertical
 : RBW:1000.000kHz VBW:1000.000kHz SWT:Auto
 Project : NETWORK CAMERA
 Model : QND-7080RP
 Mode : 12 V (dc)
 Memo : (1 - 3) GHz

	Freq	Read Level	Ant Factor	Cable Loss	Preamp Factor	TPos	Limit Line	Over Limit	Pol/Phase	Remark
	MHz	dBuV	dB/m	dB	dB	deg	dBuV/m	dB		
1	1336.00	40.62	25.24	7.48	39.96	263	56.00	-22.62	vertical	Average
2	1336.00	56.64	25.24	7.48	39.96	263	76.00	-26.60	vertical	Peak
3	1596.00	31.62	26.28	8.24	39.83	41	56.00	-29.69	vertical	Average
4	1596.00	55.17	26.28	8.24	39.83	41	76.00	-26.14	vertical	Peak
5 pp	1782.00	51.54	27.01	8.75	39.74	283	56.00	-8.44	vertical	Average
6 pk	1782.00	56.71	27.01	8.75	39.74	283	76.00	-23.27	vertical	Peak
7	1930.00	39.66	27.60	9.16	39.66	110	56.00	-19.24	vertical	Average
8	1930.00	50.28	27.60	9.16	39.66	110	76.00	-28.62	vertical	Peak
9	2228.00	39.19	28.44	9.70	39.76	86	56.00	-18.43	vertical	Average
10	2228.00	47.49	28.44	9.70	39.76	86	76.00	-30.13	vertical	Peak
11	2970.00	35.19	30.26	11.15	40.19	154	56.00	-19.59	vertical	Average
12	2970.00	50.61	30.26	11.15	40.19	154	76.00	-24.17	vertical	Peak

This report shall not be reproduced except in full, without the written approval of KES Co., Ltd.
 The results shown in this test report refer only to the sample(s) tested unless otherwise stated.

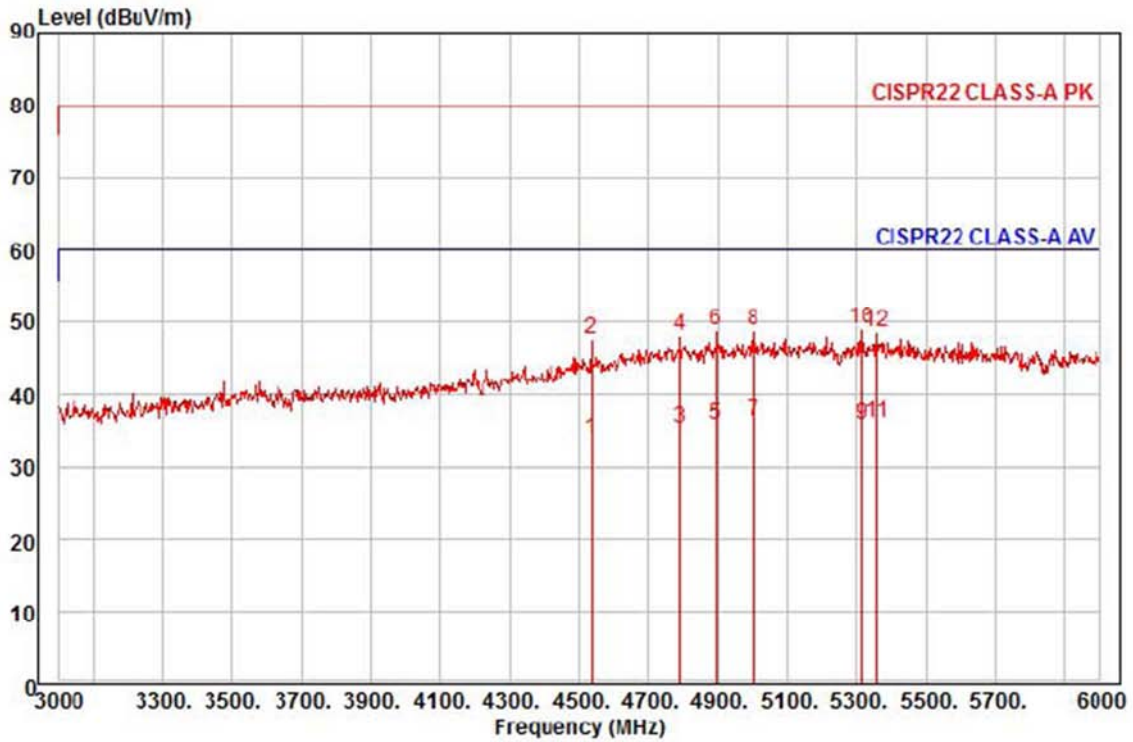

Site : chamber
 Condition: CISPR22 CLASS-A PK 3m HORN781(2015.05.07) horizontal
 : RBW:1000.000kHz VBW:1000.000kHz SWT:Auto
 Project : NETWORK CAMERA
 Model : QND-7080RP
 Mode : 12 V (dc)
 Memo : (3 - 6) GHz

	Freq	Read Level	Ant Factor	Cable Loss	Preamp Factor	TPos	Limit Line	Over Limit	Pol/Phase	Remark
	MHz	dBuV	dB/m	dB	dB	deg	dBuV/m	dB		
1	4536.00	24.71	35.07	14.49	40.41	33	60.00	-26.14	horizontal	Average
2	4536.00	38.32	35.07	14.49	40.41	33	80.00	-32.53	horizontal	Peak
3	4788.00	24.26	36.51	14.95	40.41	128	60.00	-24.69	horizontal	Average
4	4788.00	37.11	36.51	14.95	40.41	128	80.00	-31.84	horizontal	Peak
5	4896.00	24.01	37.13	15.14	40.41	157	60.00	-24.13	horizontal	Average
6	4896.00	36.87	37.13	15.14	40.41	157	80.00	-31.27	horizontal	Peak
7 pp	5001.00	23.54	37.72	15.33	40.41	45	60.00	-23.82	horizontal	Average
8	5001.00	36.20	37.72	15.33	40.41	45	80.00	-31.16	horizontal	Peak
9	5316.00	23.49	37.08	15.70	40.37	33	60.00	-24.10	horizontal	Average
10 pk	5316.00	36.65	37.08	15.70	40.37	33	80.00	-30.94	horizontal	Peak
11	5358.00	23.55	37.00	15.75	40.36	56	60.00	-24.06	horizontal	Average
12	5358.00	36.19	37.00	15.75	40.36	56	80.00	-31.42	horizontal	Peak

This report shall not be reproduced except in full, without the written approval of KES Co., Ltd.
 The results shown in this test report refer only to the sample(s) tested unless otherwise stated.

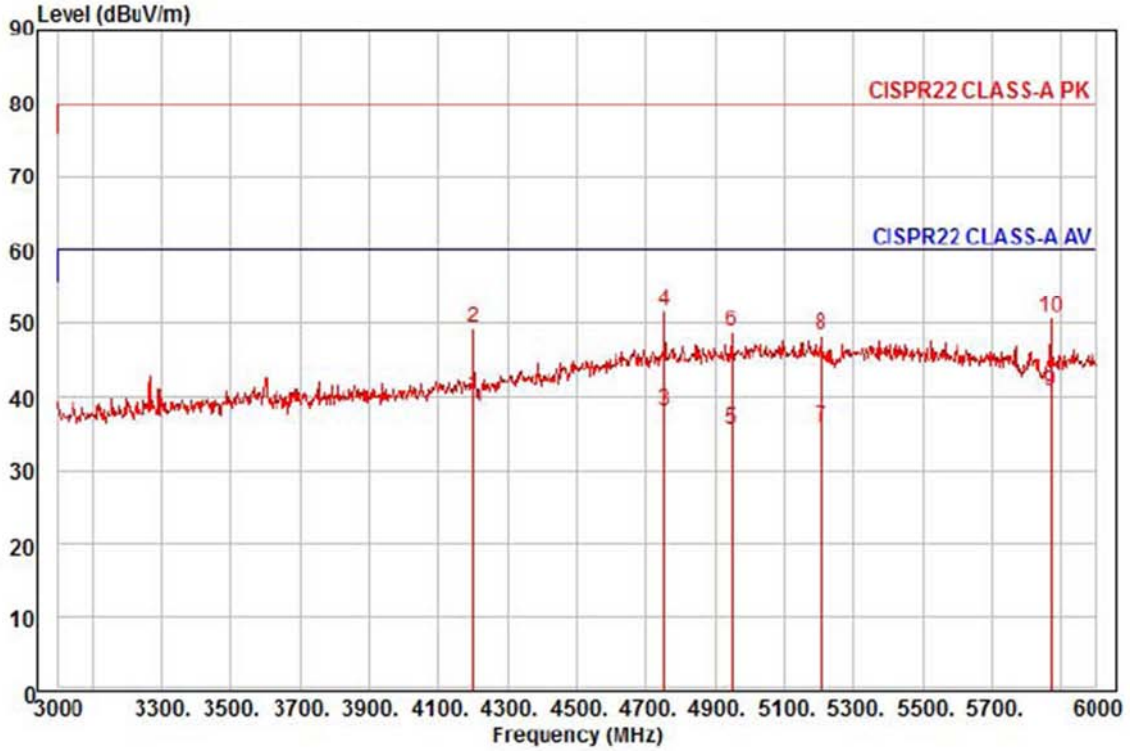

Site : chamber
 Condition: CISPR22 CLASS-A PK 3m HORN781(2015.05.07) vertical
 : RBW:1000.000kHz VBW:1000.000kHz SWT:Auto
 Project : NETWORK CAMERA
 Model : QND-7080RP
 Mode : 12 V (dc)
 Memo : (3 - 6) GHz

	Read	Ant	Cable	Preamp	TPos	Limit	Over			
Freq	Level	Factor	Loss	Factor		Line	Limit	Pol/Phase	Remark	
MHz	dBuV	dB/m	dB	dB	deg	dBuV/m	dB			
1	4200.00	33.55	33.15	13.88	40.41	223	60.00	-19.83	vertical	Average
2	4200.00	42.76	33.15	13.88	40.41	223	80.00	-30.62	vertical	Peak
3	4752.00	27.30	36.30	14.88	40.41	205	60.00	-21.93	vertical	Average
4 pk	4752.00	41.06	36.30	14.88	40.41	205	80.00	-28.17	vertical	Peak
5	4947.00	23.44	37.42	15.23	40.41	1	60.00	-24.32	vertical	Average
6	4947.00	36.47	37.42	15.23	40.41	1	80.00	-31.29	vertical	Peak
7	5208.00	23.36	37.30	15.58	40.38	122	60.00	-24.14	vertical	Average
8	5208.00	35.87	37.30	15.58	40.38	122	80.00	-31.63	vertical	Peak
9 pp	5871.00	28.53	35.96	16.62	40.29	65	60.00	-19.18	vertical	Average
10	5871.00	38.37	35.96	16.62	40.29	65	80.00	-29.34	vertical	Peak

This report shall not be reproduced except in full, without the written approval of KES Co., Ltd.
 The results shown in this test report refer only to the sample(s) tested unless otherwise stated.



- PoE Mode

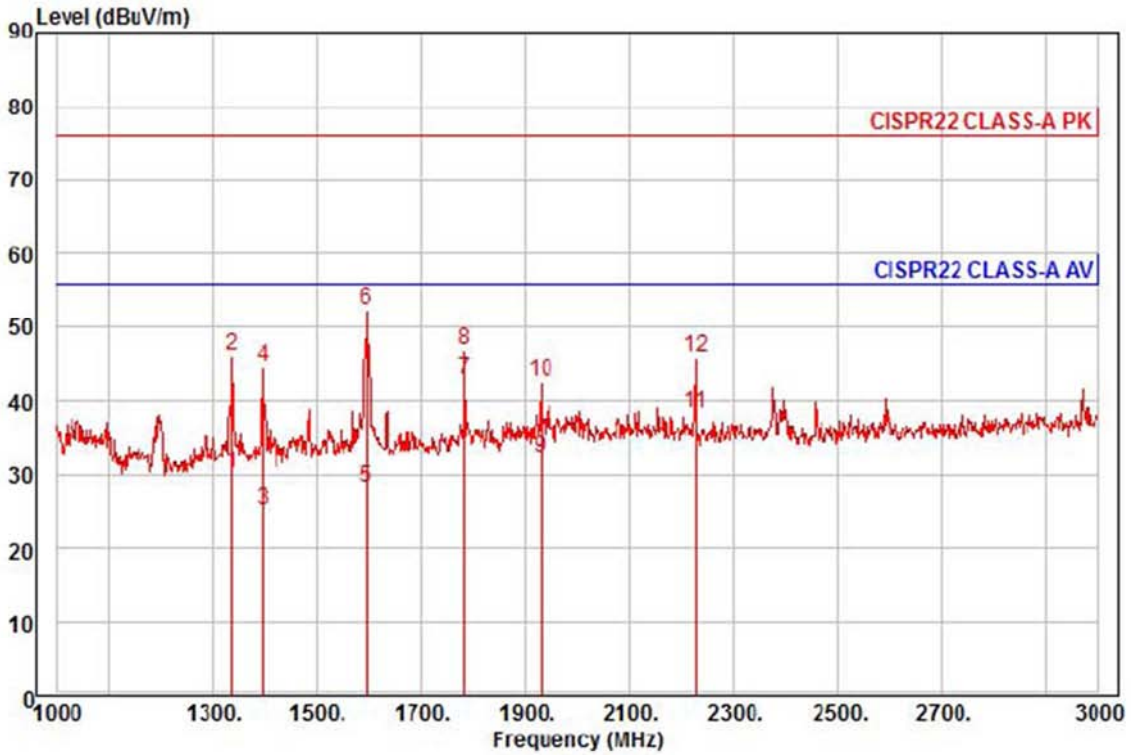

Site : chamber
 Condition: CISPR22 CLASS-A PK 3m HORN781(2015.05.07) horizontal
 : RBW:1000.000kHz VBW:1000.000kHz SWT:Auto
 Project : NETWORK CAMERA
 Model : QND-7080RP
 Mode : PoE
 Memo : (1 - 3) GHz

	Freq	Read Level	Ant Factor	Cable Loss	Preamp Factor	TPos	Limit Line	Over Limit	Pol/Phase	Remark
	MHz	dBuV	dB/m	dB	dB	deg	dBuV/m	dB		
1	1336.00	37.49	25.24	7.48	39.96	274	56.00	-25.75	horizontal	Average
2	1336.00	53.26	25.24	7.48	39.96	274	76.00	-29.98	horizontal	Peak
3	1396.00	31.93	25.48	7.66	39.93	118	56.00	-30.86	horizontal	Average
4	1396.00	51.40	25.48	7.66	39.93	118	76.00	-31.39	horizontal	Peak
5	1596.00	33.61	26.28	8.24	39.83	271	56.00	-27.70	horizontal	Average
6 pk	1596.00	57.86	26.28	8.24	39.83	271	76.00	-23.45	horizontal	Peak
7 pp	1782.00	46.83	27.01	8.75	39.74	199	56.00	-13.15	horizontal	Average
8	1782.00	50.82	27.01	8.75	39.74	199	76.00	-29.16	horizontal	Peak
9	1930.00	35.23	27.60	9.16	39.66	210	56.00	-23.67	horizontal	Average
10	1930.00	45.51	27.60	9.16	39.66	210	76.00	-33.39	horizontal	Peak
11	2228.00	39.77	28.44	9.70	39.76	342	56.00	-17.85	horizontal	Average
12	2228.00	47.39	28.44	9.70	39.76	342	76.00	-30.23	horizontal	Peak

This report shall not be reproduced except in full, without the written approval of KES Co., Ltd.
 The results shown in this test report refer only to the sample(s) tested unless otherwise stated.

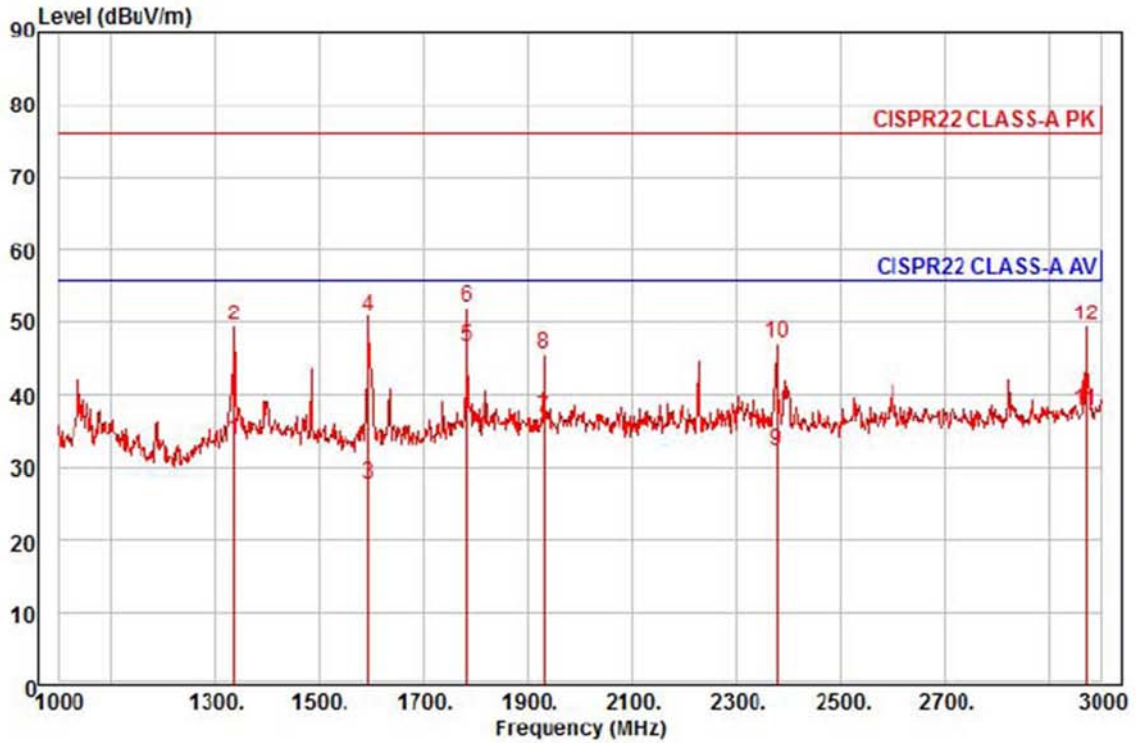

Site : chamber
 Condition: CISPR22 CLASS-A PK 3m HORN781(2015.05.07) vertical
 : RBW:1000.000kHz VBW:1000.000kHz SWT:Auto
 Project : NETWORK CAMERA
 Model : QND-7080RP
 Mode : PoE
 Memo : (1 - 3) GHz

	Read Freq	Ant Level	Ant Factor	Cable Loss	Preamp Factor	TPos	Limit Line	Over Limit	Pol/Phase	Remark
	MHz	dBuV	dB/m	dB	dB	deg	dBuV/m	dB		
1	1336.00	41.10	25.24	7.48	39.96	189	56.00	-22.14	vertical	Average
2	1336.00	56.83	25.24	7.48	39.96	189	76.00	-26.41	vertical	Peak
3	1594.00	33.08	26.27	8.23	39.83	14	56.00	-28.25	vertical	Average
4	1594.00	56.22	26.27	8.23	39.83	14	76.00	-25.11	vertical	Peak
5 pp	1782.00	50.50	27.01	8.75	39.74	270	56.00	-9.48	vertical	Average
6 pk	1782.00	56.17	27.01	8.75	39.74	270	76.00	-23.81	vertical	Peak
7	1930.00	39.56	27.60	9.16	39.66	25	56.00	-19.34	vertical	Average
8	1930.00	48.47	27.60	9.16	39.66	25	76.00	-30.43	vertical	Peak
9	2378.00	33.53	28.81	9.93	39.85	276	56.00	-23.58	vertical	Average
10	2378.00	48.16	28.81	9.93	39.85	276	76.00	-28.95	vertical	Peak
11	2970.00	36.43	30.26	11.15	40.19	201	56.00	-18.35	vertical	Average
12	2970.00	48.40	30.26	11.15	40.19	201	76.00	-26.38	vertical	Peak

This report shall not be reproduced except in full, without the written approval of KES Co., Ltd.
 The results shown in this test report refer only to the sample(s) tested unless otherwise stated.

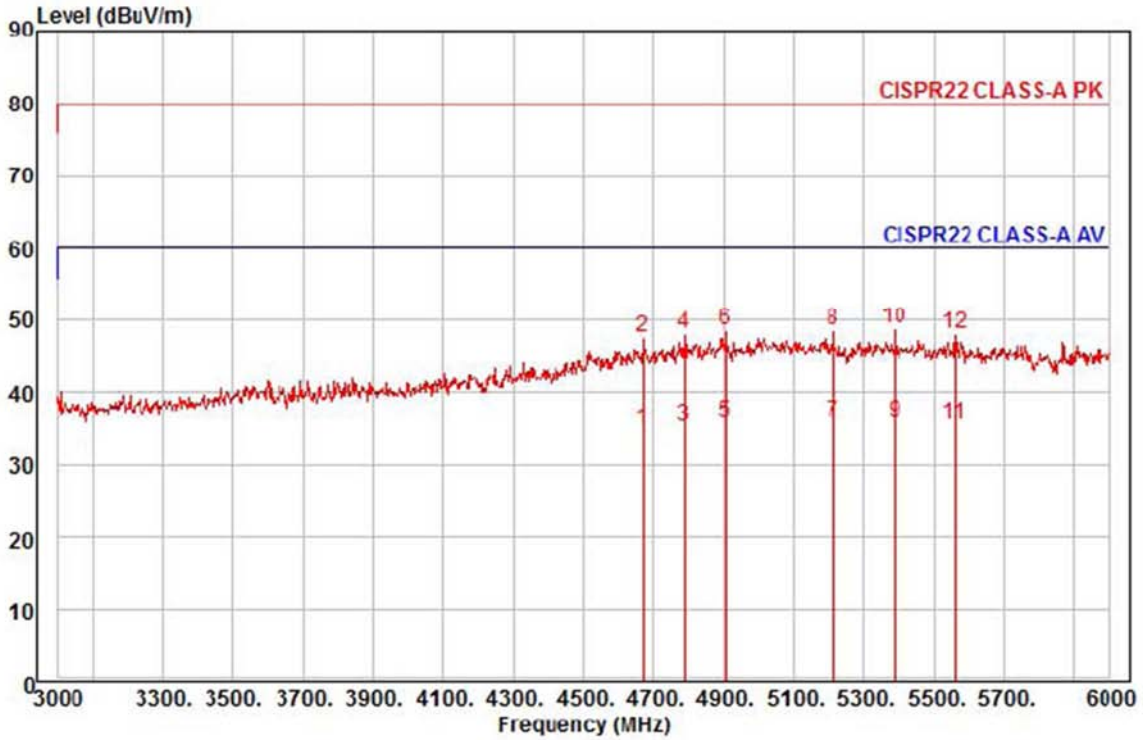

Site : chamber
 Condition: CISPR22 CLASS-A PK 3m HORN781(2015.05.07) horizontal
 : RBW:1000.000kHz VBW:1000.000kHz SWT:Auto
 Project : NETWORK CAMERA
 Model : QND-7080RP
 Mode : PoE
 Memo : (3 - 6) GHz

	Read Freq	Ant Level	Ant Factor	Cable Loss	Preamp Factor	TPos	Limit Line	Over Limit	Pol/Phase	Remark
	MHz	dBuV	dB/m	dB	dB	deg	dBuV/m	dB		
1	4671.00	24.68	35.84	14.74	40.41	213	60.00	-25.15	horizontal	Average
2	4671.00	37.47	35.84	14.74	40.41	213	80.00	-32.36	horizontal	Peak
3	4785.00	24.20	36.49	14.94	40.41	141	60.00	-24.78	horizontal	Average
4	4785.00	37.00	36.49	14.94	40.41	141	80.00	-31.98	horizontal	Peak
5	4905.00	23.77	37.18	15.16	40.41	46	60.00	-24.30	horizontal	Average
6	4905.00	36.73	37.18	15.16	40.41	46	80.00	-31.34	horizontal	Peak
7 pp	5214.00	23.37	37.29	15.58	40.38	279	60.00	-24.14	horizontal	Average
8	5214.00	36.14	37.29	15.58	40.38	279	80.00	-31.37	horizontal	Peak
9	5388.00	23.47	36.94	15.79	40.36	152	60.00	-24.16	horizontal	Average
10 pk	5388.00	36.35	36.94	15.79	40.36	152	80.00	-31.28	horizontal	Peak
11	5559.00	23.23	36.59	16.03	40.33	342	60.00	-24.48	horizontal	Average
12	5559.00	35.83	36.59	16.03	40.33	342	80.00	-31.88	horizontal	Peak

This report shall not be reproduced except in full, without the written approval of KES Co., Ltd.
 The results shown in this test report refer only to the sample(s) tested unless otherwise stated.

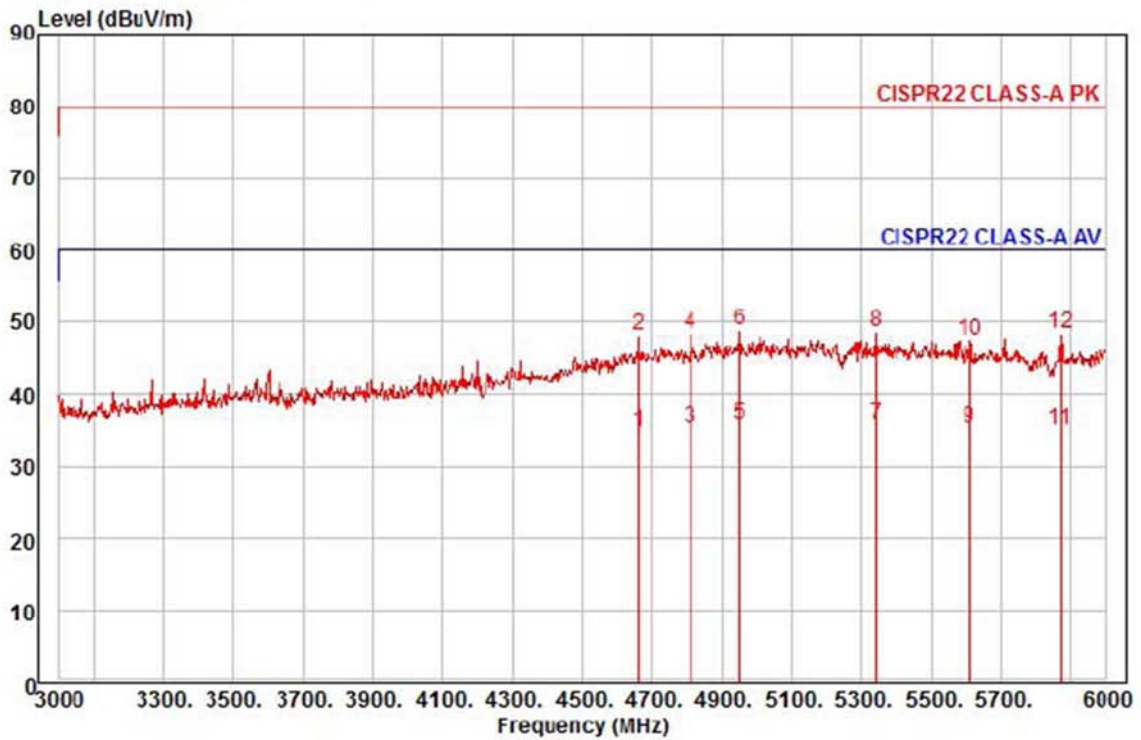

Site : chamber
 Condition: CISPR22 CLASS-A PK 3m HORN781(2015.05.07) vertical
 : RBW:1000.000kHz VBW:1000.000kHz SWT:Auto
 Project : NETWORK CAMERA
 Model : QND-7080RP
 Mode : PoE
 Memo : (3 - 6) GHz

	Freq	Read Level	Ant Factor	Cable Loss	Preamp Factor	TPos	Limit Line	Over Limit	Pol/Phase	Remark
	MHz	dBuV	dB/m	dB	dB	deg	dBuV/m	dB		
1	4662.00	24.69	35.79	14.72	40.41	309	60.00	-25.21	vertical	Average
2	4662.00	37.93	35.79	14.72	40.41	309	80.00	-31.97	vertical	Peak
3	4812.00	24.02	36.65	14.99	40.41	209	60.00	-24.75	vertical	Average
4	4812.00	37.04	36.65	14.99	40.41	209	80.00	-31.73	vertical	Peak
5	4950.00	23.44	37.43	15.24	40.41	75	60.00	-24.30	vertical	Average
6 pk	4950.00	36.44	37.43	15.24	40.41	75	80.00	-31.30	vertical	Peak
7 pp	5340.00	23.52	37.03	15.73	40.36	212	60.00	-24.08	vertical	Average
8	5340.00	36.27	37.03	15.73	40.36	212	80.00	-31.33	vertical	Peak
9	5610.00	22.97	36.49	16.13	40.32	130	60.00	-24.73	vertical	Average
10	5610.00	35.05	36.49	16.13	40.32	130	80.00	-32.65	vertical	Peak
11	5871.00	22.90	35.96	16.62	40.29	87	60.00	-24.81	vertical	Average
12	5871.00	36.07	35.96	16.62	40.29	87	80.00	-31.64	vertical	Peak

This report shall not be reproduced except in full, without the written approval of KES Co., Ltd.
 The results shown in this test report refer only to the sample(s) tested unless otherwise stated.



Harmonic Current Emissions and Voltage Fluctuations and Flicker

Average harmonic current results

Hn	I _{eff} [A]	% of Limit	Limit [A]	Result
1	N/A			
2				
3				
4				
5				
6				
7				
8				
9				
10				
11				
12				
13				
14				
15				
16				
17				
18				
19				
20				
21				
22				
23				
24				
25				
26				
27				
28				
29				
30				
31				
32				
33				
34				
35				
36				
37				
38				
39				
40				

Harmonic currents less than 0.6% of the input current measured under the test conditions, or less than 5 mA, whichever is greater, are disregarded.

This report shall not be reproduced except in full, without the written approval of KES Co., Ltd.
The results shown in this test report refer only to the sample(s) tested unless otherwise stated.



Test Data - Harmonics (continued)

Maximum harmonic current results				
Hn	I _{eff} [A]	% of Limit	Limit [A]	Result
1	N/A			
2				
3				
4				
5				
6				
7				
8				
9				
10				
11				
12				
13				
14				
15				
16				
17				
18				
19				
20				
21				
22				
23				
24				
25				
26				
27				
28				
29				
30				
31				
32				
33				
34				
35				
36				
37				
38				
39				
40				

Harmonic currents less than 0.6% of the input current measured under the test conditions, or less than 5 mA, whichever is greater, are disregarded.

This report shall not be reproduced except in full, without the written approval of KES Co., Ltd.
The results shown in this test report refer only to the sample(s) tested unless otherwise stated.



Test Data - Voltage Fluctuations

Maximum Flicker results

	EUT values	Limit	Result
Pst	N/A		
Plt			
dc [%]			
dmax [%]			
Tmax [s]			

This report shall not be reproduced except in full, without the written approval of KES Co., Ltd.
The results shown in this test report refer only to the sample(s) tested unless otherwise stated.



KES Co., Ltd.

C-3701, Simin-daero 365-40,
Dongan-gu, Anyang-si, Gyeonggi-do, 14057, Korea
Tel: +82-31-425-6200 / Fax: +82-31-424-0450
www.kes.co.kr

Test report No.:
KES-E1-16T0336
Page (56) of (78)

Test Setup Photos and Configuration

Conducted Voltage Emissions

N/A

N/A

This report shall not be reproduced except in full, without the written approval of KES Co., Ltd.
The results shown in this test report refer only to the sample(s) tested unless otherwise stated.

Conducted Telecommunication Emissions

- 12 V (dc) Mode



This report shall not be reproduced except in full, without the written approval of KES Co., Ltd.
The results shown in this test report refer only to the sample(s) tested unless otherwise stated.

- PoE Mode

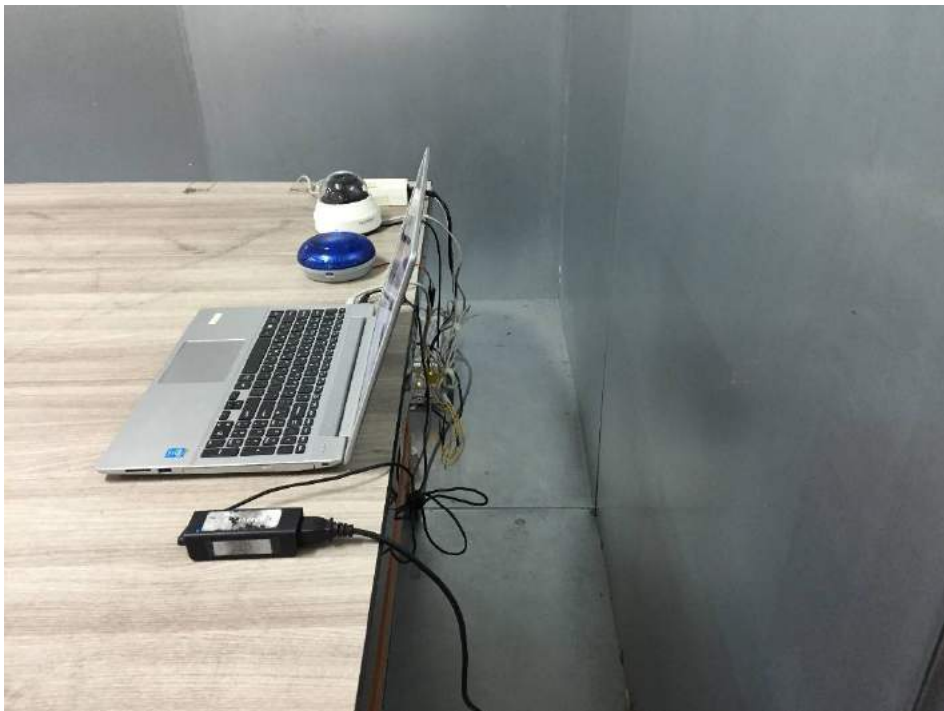

This report shall not be reproduced except in full, without the written approval of KES Co., Ltd.
The results shown in this test report refer only to the sample(s) tested unless otherwise stated.

Radiated Electric Field Emissions(Below 1 GHz)

- 12 V (dc) Mode

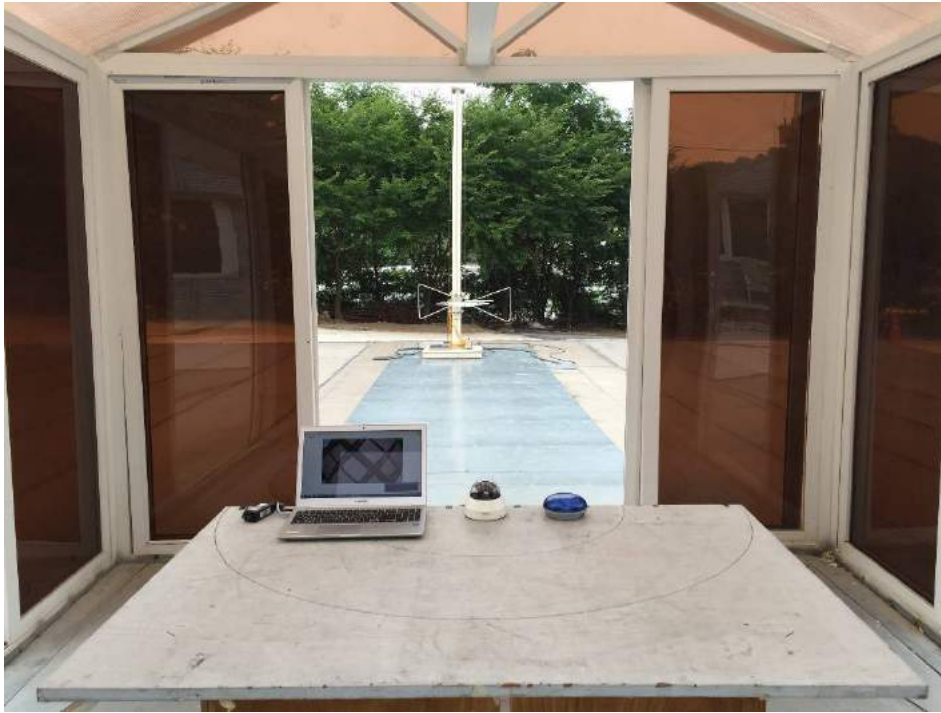

This report shall not be reproduced except in full, without the written approval of KES Co., Ltd.
The results shown in this test report refer only to the sample(s) tested unless otherwise stated.

- PoE Mode

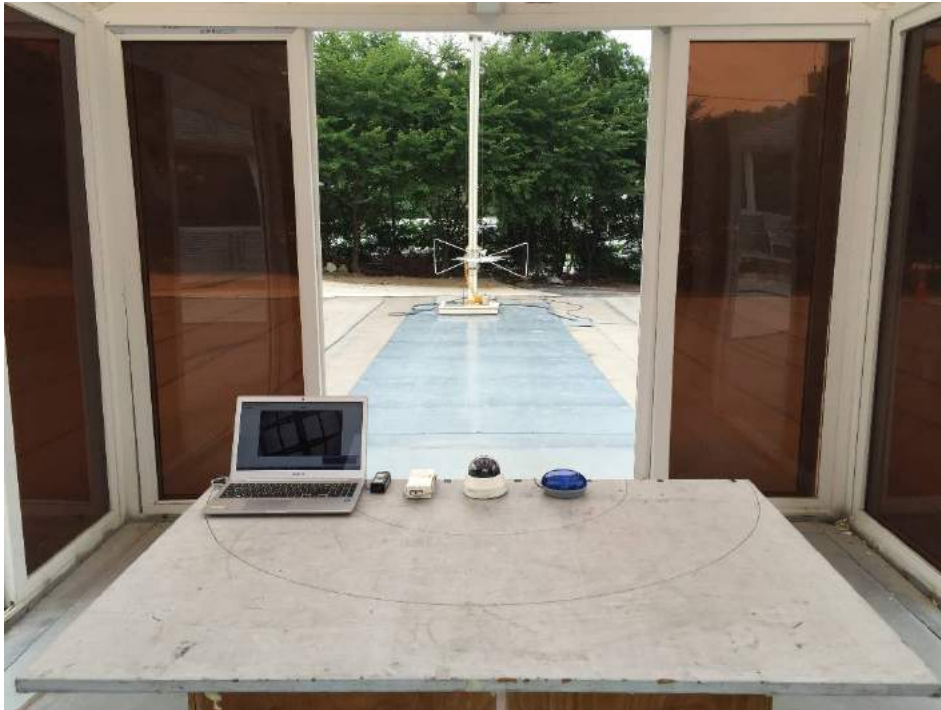

This report shall not be reproduced except in full, without the written approval of KES Co., Ltd.
The results shown in this test report refer only to the sample(s) tested unless otherwise stated.

Radiated Electric Field Emissions(Above 1 GHz)

- 12 V (dc) Mode

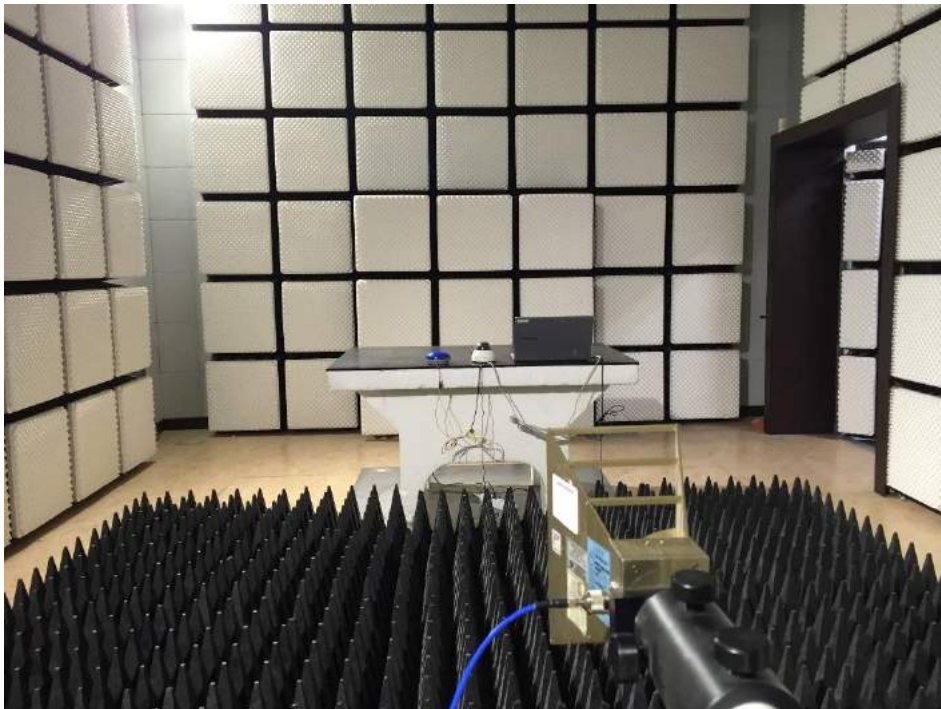
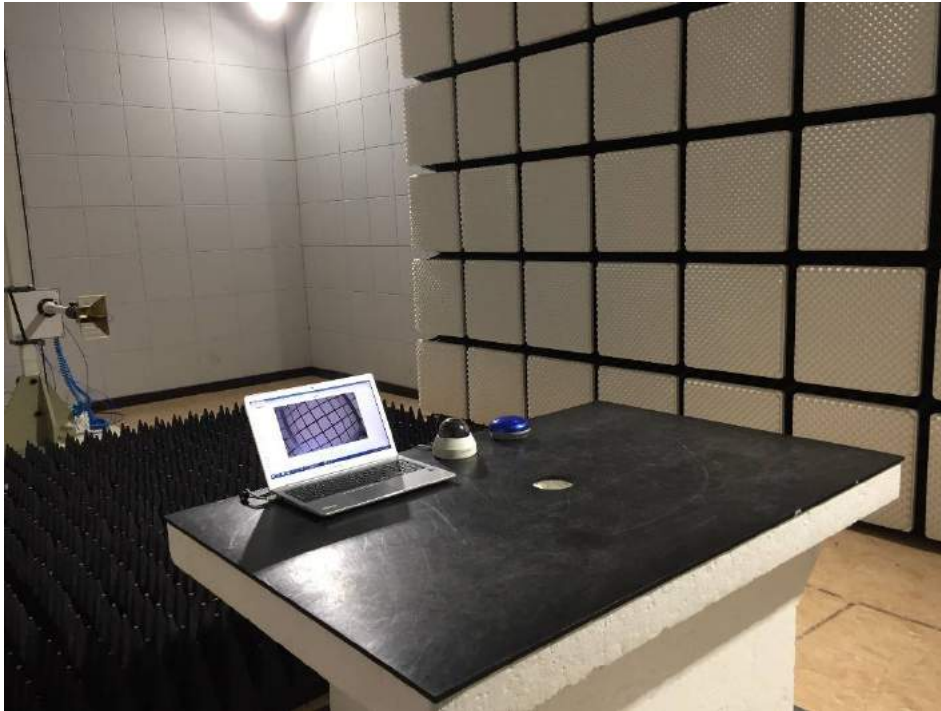

This report shall not be reproduced except in full, without the written approval of KES Co., Ltd.
The results shown in this test report refer only to the sample(s) tested unless otherwise stated.

- PoE Mode



This report shall not be reproduced except in full, without the written approval of KES Co., Ltd.
The results shown in this test report refer only to the sample(s) tested unless otherwise stated.



KES Co., Ltd.

C-3701, Simin-daero 365-40,
Dongan-gu, Anyang-si, Gyeonggi-do, 14057, Korea
Tel: +82-31-425-6200 / Fax: +82-31-424-0450
www.kes.co.kr

Test report No.:
KES-E1-16T0336
Page (63) of (78)

Harmonic Current Emissions and Voltage Fluctuations and Flicker

N/A

This report shall not be reproduced except in full, without the written approval of KES Co., Ltd.
The results shown in this test report refer only to the sample(s) tested unless otherwise stated.

Electrostatic Discharge

- 12 V (dc) Mode



- PoE Mode



This report shall not be reproduced except in full, without the written approval of KES Co., Ltd.
The results shown in this test report refer only to the sample(s) tested unless otherwise stated.

Radiated Electric Field Immunity

- 12 V (dc) Mode



- PoE Mode

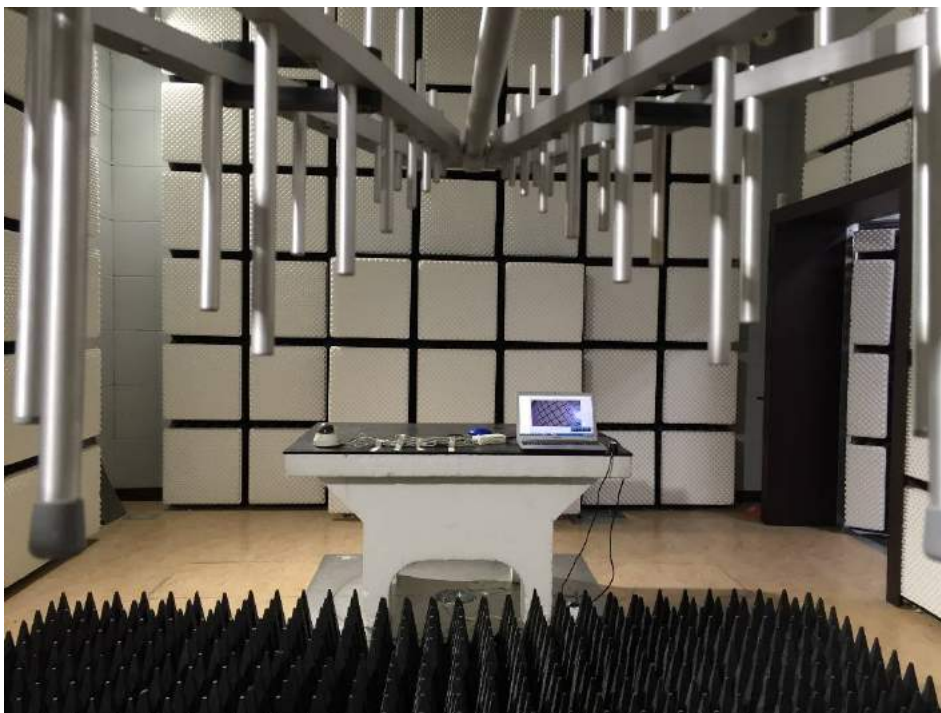

This report shall not be reproduced except in full, without the written approval of KES Co., Ltd.
The results shown in this test report refer only to the sample(s) tested unless otherwise stated.

Electrical Fast Transients/Bursts

- 12 V (dc) Mode



This report shall not be reproduced except in full, without the written approval of KES Co., Ltd.
The results shown in this test report refer only to the sample(s) tested unless otherwise stated.

- PoE Mode



This report shall not be reproduced except in full, without the written approval of KES Co., Ltd.
The results shown in this test report refer only to the sample(s) tested unless otherwise stated.

Surge Transients

- 12 V (dc) Mode



- PoE Mode



This report shall not be reproduced except in full, without the written approval of KES Co., Ltd.
The results shown in this test report refer only to the sample(s) tested unless otherwise stated.

Conducted Disturbance

- 12 V (dc) Mode

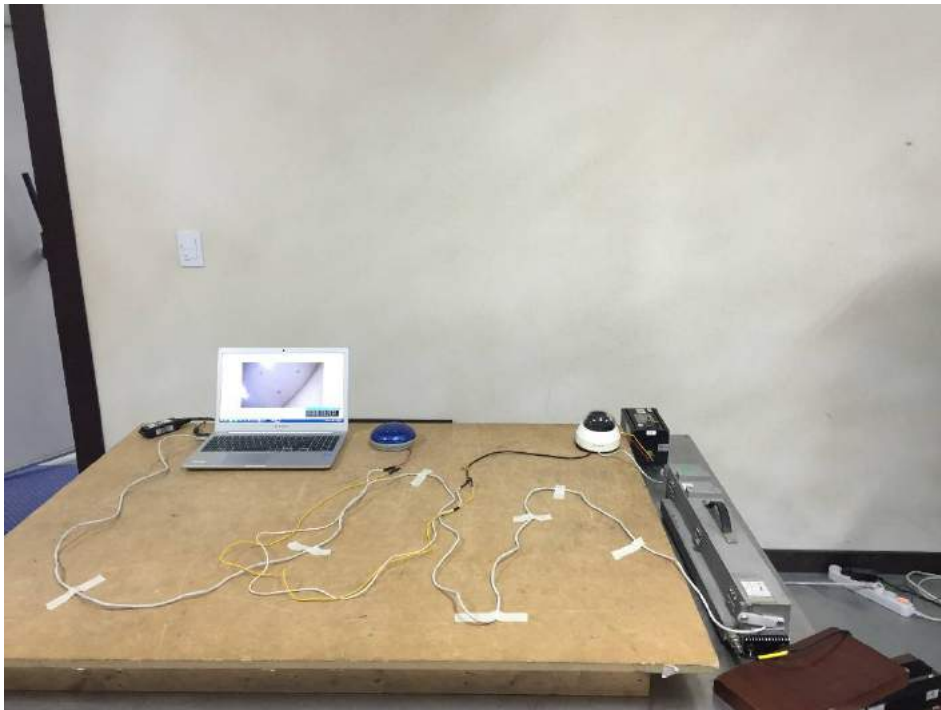

This report shall not be reproduced except in full, without the written approval of KES Co., Ltd.
The results shown in this test report refer only to the sample(s) tested unless otherwise stated.

- PoE Mode



This report shall not be reproduced except in full, without the written approval of KES Co., Ltd.
The results shown in this test report refer only to the sample(s) tested unless otherwise stated.



KES Co., Ltd.

C-3701, Simin-daero 365-40,
Dongan-gu, Anyang-si, Gyeonggi-do, 14057, Korea
Tel: +82-31-425-6200 / Fax: +82-31-424-0450
www.kes.co.kr

Test report No.:
KES-E1-16T0336
Page (71) of (78)

Voltage Dips and Short Interruptions

N/A

This report shall not be reproduced except in full, without the written approval of KES Co., Ltd.
The results shown in this test report refer only to the sample(s) tested unless otherwise stated.

EUT External Photographs

(Top)



(Bottom)



This report shall not be reproduced except in full, without the written approval of KES Co., Ltd.
The results shown in this test report refer only to the sample(s) tested unless otherwise stated.

EUT Internal Photographs

(Internal View)



This report shall not be reproduced except in full, without the written approval of KES Co., Ltd.
The results shown in this test report refer only to the sample(s) tested unless otherwise stated.

EUT Internal View – Main Board

(Top)

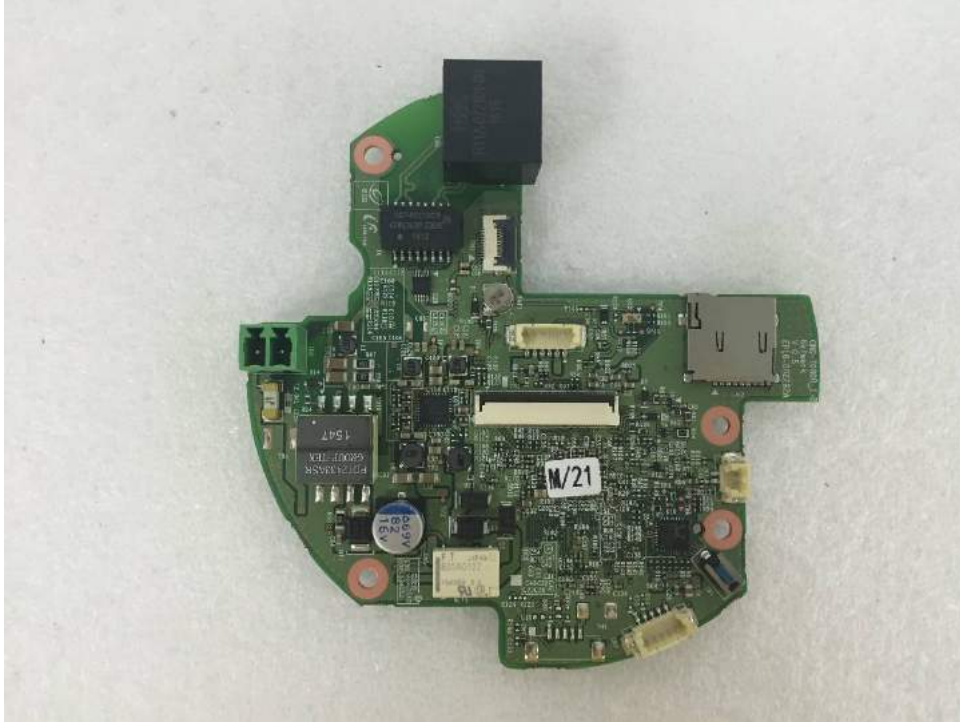

(Bottom)



This report shall not be reproduced except in full, without the written approval of KES Co., Ltd.
The results shown in this test report refer only to the sample(s) tested unless otherwise stated.

EUT Internal View – IR LED Board

(Top)



(Bottom)



This report shall not be reproduced except in full, without the written approval of KES Co., Ltd.
The results shown in this test report refer only to the sample(s) tested unless otherwise stated.

EUT Internal View – SENSOR Board

(Top)

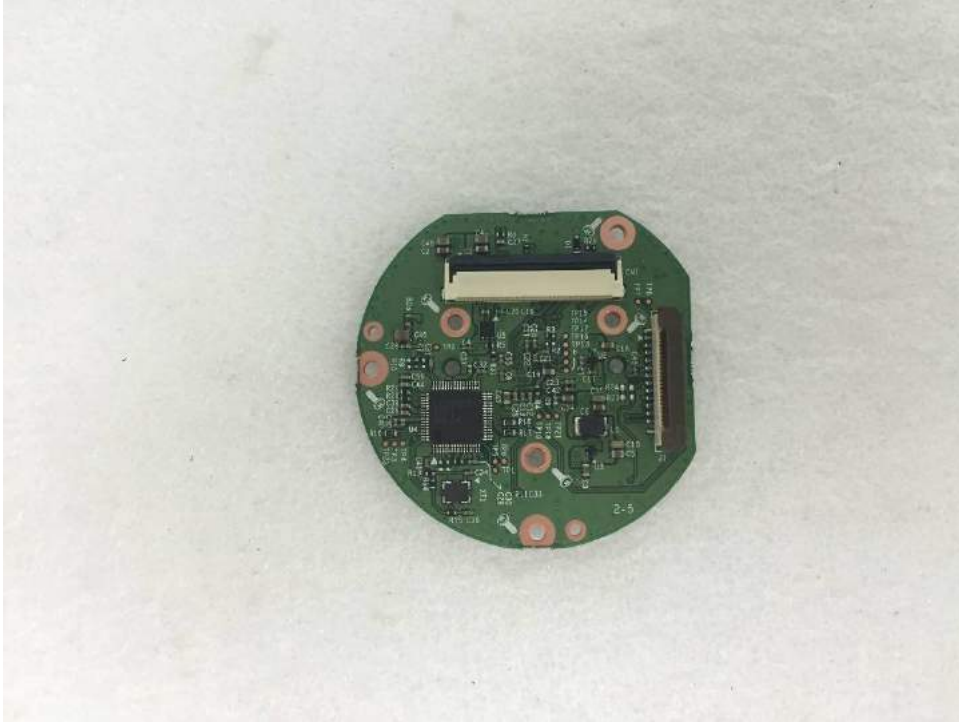

(Bottom)

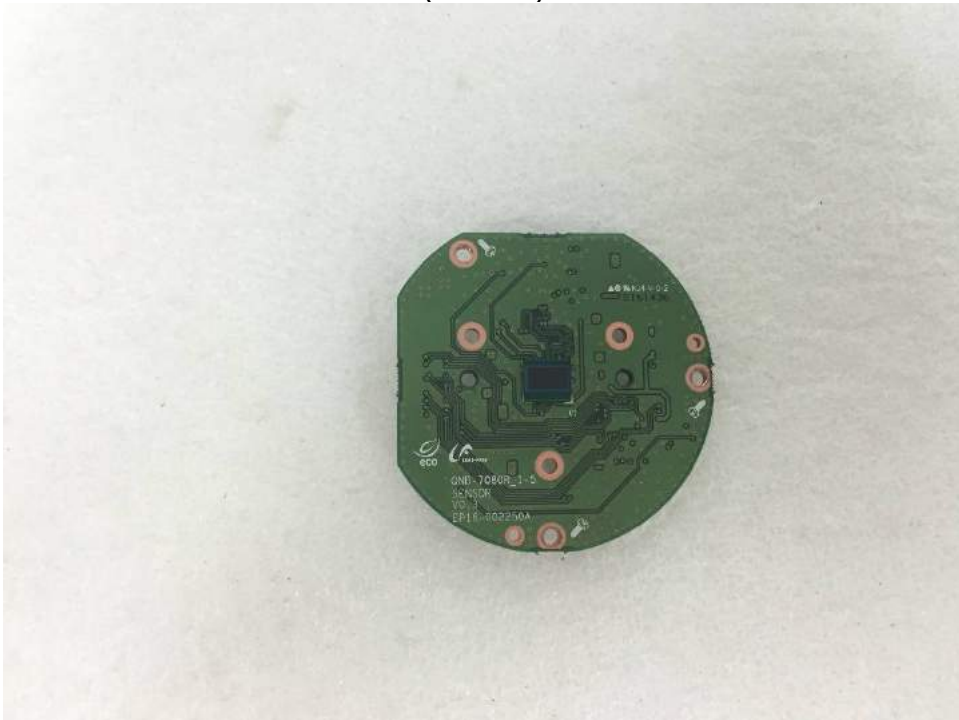

This report shall not be reproduced except in full, without the written approval of KES Co., Ltd.
The results shown in this test report refer only to the sample(s) tested unless otherwise stated.

EUT Internal View – Lens

(Top)



(Bottom)



This report shall not be reproduced except in full, without the written approval of KES Co., Ltd.
The results shown in this test report refer only to the sample(s) tested unless otherwise stated.

Label and Location

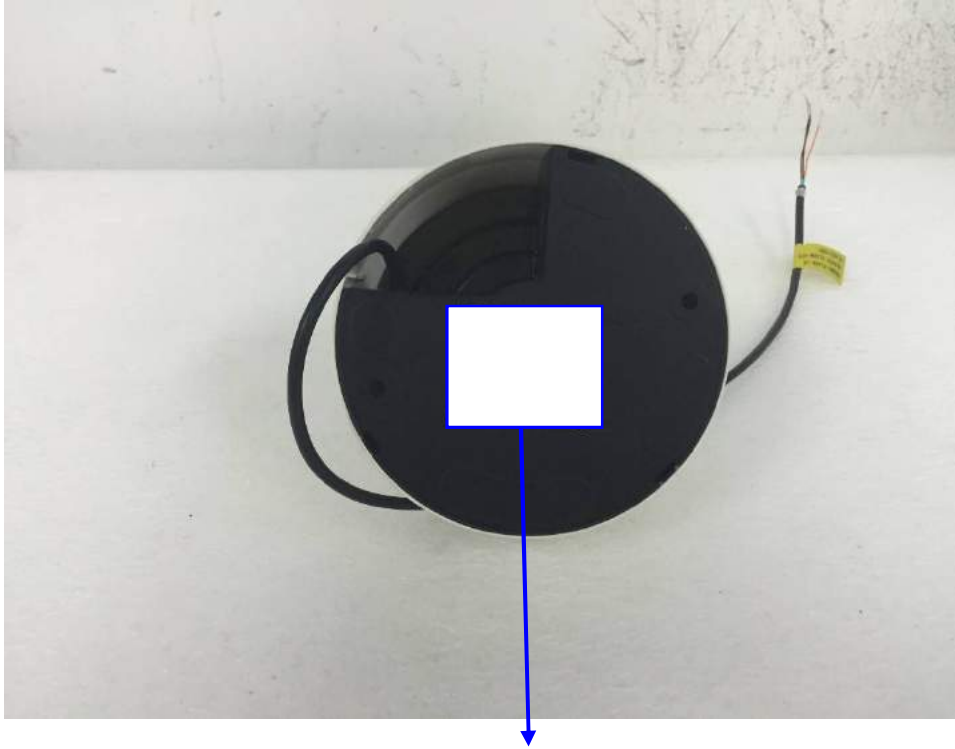

NETWORK CAMERA

Model No : QND-7080RP

Manufacturer : Tianjin Samsung Techwin Opto-Electronic Co.,Ltd.

Made in China