



Declaration of Conformity



Type of equipment: Network Encoder
Brand Name /Trade Mark: SAMSUNG
Type designation /model: SPE-400
Applicant: SAMSUNG TECHWIN CO., LTD.

In accordance with the following Directives:

2004/108/EC The Electromagnetic Compatibility Directive

Including amendments by the CE Marking Directive 93/68/EEC

The following harmonized European standards or technical specifications have been applied:

EN 55022:2007	Limits and methods of measurement of radio disturbance characteristics of information technology equipment
EN 50130-4:1995 +A1:1998 +A2:2003	Product family standard: Immunity requirements for components of fire, intruder and social alarm systems
EN 61000-4-2:1995 +A1:1998 +A2:2001	Electrostatic discharge immunity test
EN 61000-4-3:2006	Radiated, radio-frequency, electromagnetic field immunity test
EN 61000-4-4:2004	Electrical fast transient/burst immunity test
EN 61000-4-5: 2006	Surge immunity test
EN 61000-4-6:2007	Immunity to conducted disturbances, induced by radio-frequency fields

The CE Marking on the products and/or their packaging signifies that SAMSUNG TECHWIN CO., LTD. holds the reference technical file available to the European Union authorities.

Place and date of issue: #42 Seongju-Dong, Changwon-si, Kyungsangnam-do,
Korea #/ November 17, 2010

Authorized Signatory: Name : Kang Jei Soon
Title : Principal Research Engineer
Signature :

Chang Suk Oh
SAMSUNG TECHWIN CO., LTD

EMC TEST REPORT

Test report No: EMC-CE-2345
Type of Equipment: Network Encoder
Model Name: SPE-400
Applicant: SAMSUNG TECHWIN CO., LTD.
#42 Seongju-Dong, Changwon-si,
Kyungsangnam-do, Korea
Manufacturer: SAMSUNG TECHWIN CO., LTD.
#42 Seongju-Dong, Changwon-si,
Kyungsangnam-do, Korea
Test standards: EN 55022:2007, Class A
EN 50130-4:1995+A1:1998+A2:2003
EN 61000-3-2:2006
EN 61000-3-3:1995+A1:2001+A2:2005
Testing Laboratory: EMC Compliance Ltd.
Test result: Complied

This product complies with the requirements of the EMC Directive 2004/108/EC.
The results in this report apply only to the sample tested.
This test report shall not be reproduced, except in full, without the written approval
of EMC compliance Laboratory.

Date of receipt: 2010. 11. 04

Date of testing: 2010. 11. 10 ~ 11. 13

Issued date: 2010. 11. 17

Tested by: _____

KIM, IN-HO

Approved by: _____

YU, SANG-HOON

Contents

1. Applicant information	3
2. Laboratory information	4
3. Test system configuration.....	5
3.1 Operation environment	5
3.2 Measurement Uncertainty	6
4. Description of E.U.T.	7
4.1 General information.....	7
4.2 Product description	8
4.3 Auxiliary equipments	8
4.4 Test configuration	9
4.5 Operating conditions.....	10
5. Summary of test results.....	11
5.1 Modification to the E.U.T.	11
5.2 Summary of EMI emission test results	11
5.3 Summary of immunity test results	11
5.4 Performance criteria.....	12
6. Test results	14
6.1 Conducted Emission	14
6.2 Radiated Emission	23
6.3 Harmonics.....	29
6.4 Flicker.....	34
6.5 Electrostatic Discharge	37
6.6 Radio Frequency Electromagnetic Fields	41
6.7 Electric Fast Transient/BURST.....	43
6.8 Surge	46
6.9 Conducted Immunity	49
6.10 Dips and Interruptions	53
6.11 Mains supply voltage variations.....	56
7. E.U.T. photographs.....	57

1. Applicant information

Applicant: SAMSUNG TECHWIN CO., LTD.
Address: #42 Seongju-Dong, Changwon-si,
Kyungsangnam-do, Korea
Telephone: +82-70-7147-8376
Fax: +82-31-8018-3717
E-mail: js2002.kang@samsung.com
Contact name: **Kang Jei Soon**

Manufacturer: SAMSUNG TECHWIN CO., LTD.
Address: #42 Seongju-Dong, Changwon-si,
Kyungsangnam-do, Korea
Telephone: +82-70-7147-8376
Fax: +82-31-8018-3717
E-mail: js2002.kang@samsung.com
Contact name: **Kang Jei Soon**

2. Laboratory information

Address

EMC compliance Ltd.

480-5 Sin-dong, Yeongtong-gu, Suwon-city, Gyeonggi-do, 443-390, Korea

Telephone Number: 82 31 336 9919

Facsimile Number: 82 31 336 4767

FCC CAB.: KR0040

VCCI Registration No.: R-3327, G-198, C-3706, T-1849

Industry Canada Registration No.: 8035A

KOLAS NO.: 231

SITE MAP

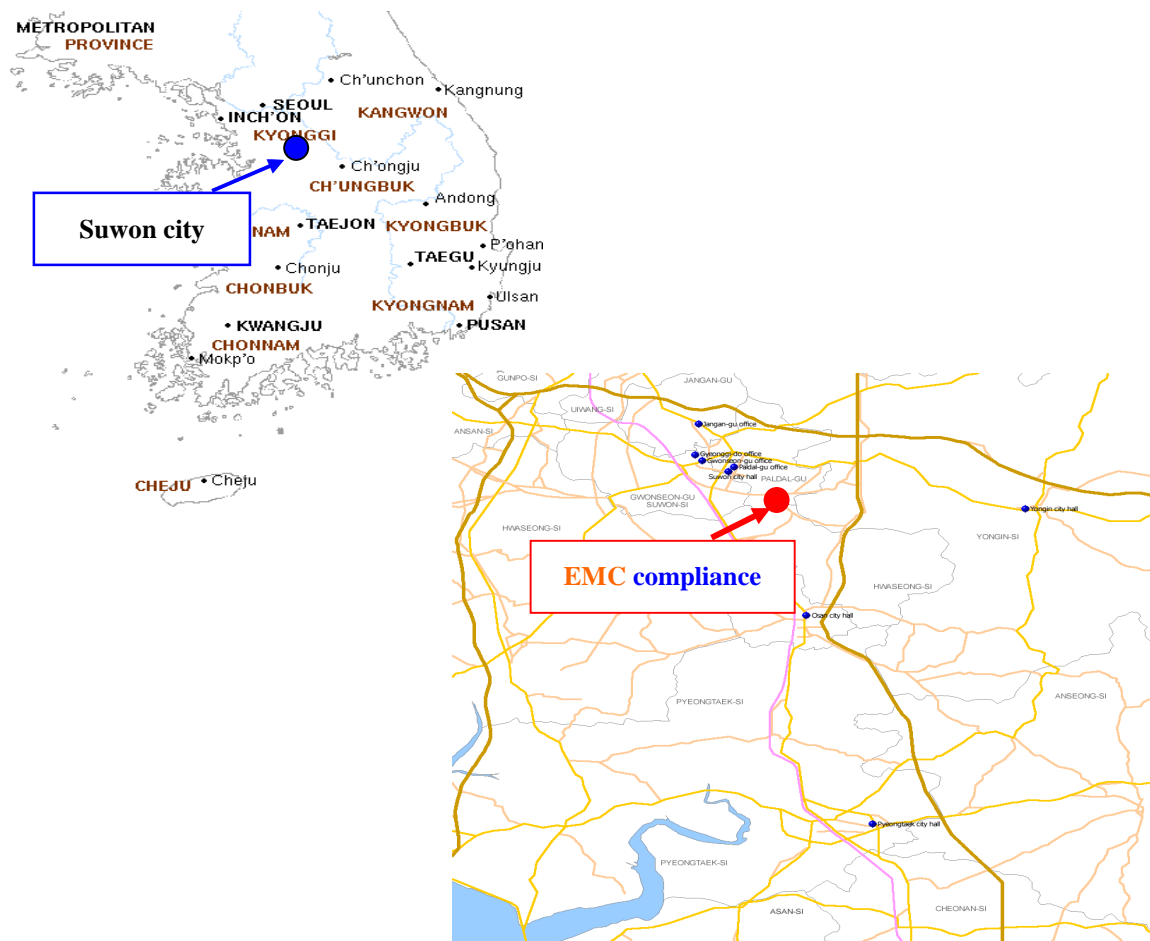

3. Test system configuration

3.1 Operation environment

	Temperature	Humidity	Pressure
Chamber(10 m)	: 25 °C	38 % R.H.	-
Shielded room(CE)	: 24 °C	32 % R.H.	-
Shielded room(ESD)	: 20 °C	35 % R.H.	101.0 kPa

Test site

These testing items were performed following locations;

Shielded Room	: Conducted Emission, ESD, EFT/Burst, Surge, CS, Dip/Interruption, Voltage variation
Immunity area	: Harmonics, Flicker
Chamber (10 m)	: Radiated Emission (Test distance: 3 m, 10 m)
Fully anechoic chamber (3 m)	: RS

3.2 Measurement Uncertainty

All measurements involve certain levels of uncertainties, especially in field of EMC. The factors contributing to uncertainties are test receiver, cable loss, antenna factor calibration, Antenna directivity, antenna factor variation with height, antenna phase center variation, antenna frequency interpolation, measurement distance variation, site imperfection, mismatch, and system repeatability. Based on CISPR 16-4-2, the measurement uncertainty level with a 95 % confidence level was applied.

Conducted emission measurement : ($k = 2$, 95 %)

9 kHz ~ 150 kHz: ± 3.77 [dB]

150 kHz ~ 30 MHz: ± 3.35 [dB]

Radiated Emission measurement : ($k = 2$, 95 %)

30 MHz ~ 300 MHz: 3 m: ± 4.3 [dB]

10 m: ± 4.3 [dB]

300 MHz ~ 1 000 MHz: 3 m: ± 4.4 [dB]

10 m: ± 4.3 [dB]

Radio Frequency Electromagnetic Fields : ($k = 2$, 95 %)

± 1.09 [dB]

4. Description of E.U.T.

4.1 General information

	FCC: SPE-400	CE: SPE-400
Operational		
Video In	4 CVBS : 1.0 Vp-p / 75Ω composite, NTSC/PAL Auto Detection	
Video Out	N/A	
De-interlacing Filter	Built-in	
Event Trigger	Motion Detection, Alarm Input, Video Loss	
Alarm I/O	Input 4ea / Output 4ea (Relay)	
Remote Control Interface	4ea RS-485	
RS-485 Protocol	SAMSUNG T/E, PELCO-P/D	
Network		
Ethernet	RJ-45 (10/100/1000BASE-T)	
Video Compression Format	H.264, MPEG4, MJPEG	
Resolution	704x480, 640x480, 352x240, 320x240	704x576, 640x480, 352x288, 320x240
Max. Framerate	30fps	25fps
Video Quality Adjustment	H.264/MPEG4 : Compression Level, Target Bitrate Level Control MJPEG : Quality Level Control	
Bitrate Control Method	H.264/MPEG4 : CBR or VBR MJPEG : VBR	
Streaming Capability	Multiple Streaming (Up to 10 Profiles)	
Audio I/O	1ea Line in / 1 Line out (CH1 Only)	
Audio Compression Format	G.711 u-law	
Audio Communication	2-Way	
IP	IPv4, IPv6	
Protocol	TCP/IP, UDP/IP, RTP(UDP), RTP(TCP), RTSP, NTP, HTTP, HTTPS, SSL, DHCP, PPPoE FTP, SMTP, ICMP, IGMP, SNMPv1/v2c/v3(MIB-2), ARP, DNS, DDNS, ONVIF	
Security	HTTPS(SSL) Login Authentication Digest Login Authentication IP Address Filtering User access Log	
Streaming Method	Unicast / Multicast	
Max. User Access	10 users at Unicast Mode	
Memory Slot	SD/SDHC Memory Slot (CH1 Only)	
ONVIF Conformance	Yes	
Web Viewer	Supported OS : Windows XP / VISTA / 7, MAC OS Supported Browser : Internet Explorer 8.0 or Higher, Firefox, Google Chrome, Apple Safari	
Central Management Software	NET-i viewer	
Environmental		
Operating Temperature / Humidity	0°C ~ +40°C (+32°F ~ +104°F) / 20% ~ 80% RH	
Ingress Protection	-	
Electrical		
Input Voltage / Current	12V DC	
Power Consumption	Max. 15W	
Mechanical		
Color / Material	Silver / Metal	

4.2 Product description

Type of product	Network Encoder
Model name (Basic)	SPE-400
Model name (Variant)	N/A
Difference	-
Serial no	Engineering Sample
Trade name	-
Testing voltage	230 V , 50 Hz
Product rating	* AC/DC Adaptor (DSA-60W-121 12048) Input: AC 100 - 240 V , 50 - 60 Hz, 1.5 A Output: DC 12 V , 4A
Note	* AC/DC adaptor was provided by the manufacturer.

4.3 Auxiliary equipments

Type	Model / Part #	Serial number	Manufacturer
Controller	SC3000	-	CNB
Note PC	C1410	473680121639	FUJITSU
CCTV Camera	SDC-435P	C08C6V3Z245129	SAMSUNGTECHWIN
Controller	SCC-2000	-	SAMSUNG
Headset	MP-421	-	MANIAPC
JIG	-	-	-
SD Card (2GB)	-	BE09254143580	Sandisk

4.4 Test configuration

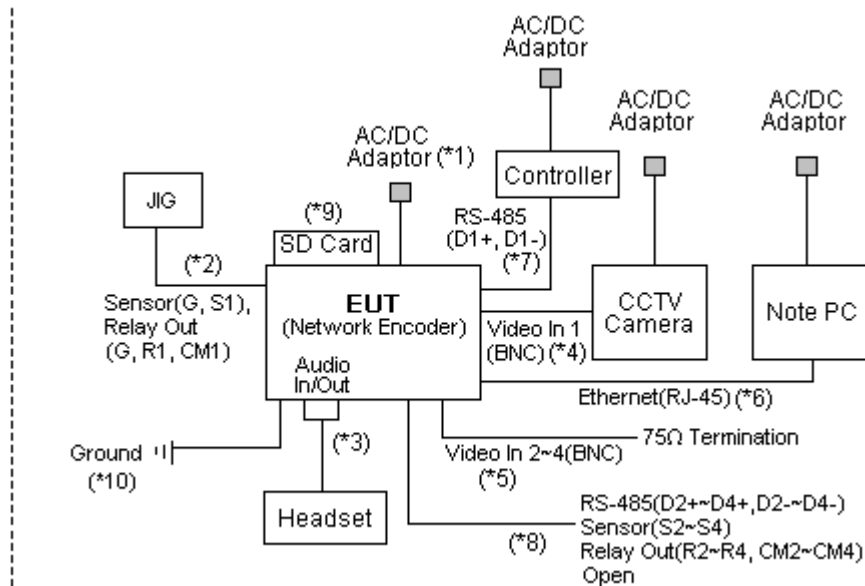

Note	Start		End		Cable			
	Name	I/O port	Name	I/O port	Length(m)	Spec.	Cable	
1		Power	AC/DC Adaptor	Power	1.5	Non-Shield	-	
2		Sensor (G, S1), Relay Out (G, R1, CM1)	JIG	Sensor (G, S1), Relay Out (G, R1, CM1)	3.0	Non-Shield	In-door	
3		Audio In, Out	Headset	Audio In, Out	2.0	Non-Shield	Out-door	
4		Video In 1 (BNC)	CCTV Camera	Video In 1 (BNC)	3.0	Shield	In-door	
5		Video In 2~4 (BNC)	75Ω Termination	-	1.5	Shield	In-door	
6	EUT (Network Encoder)	Ethernet (RJ-45)	Note PC	Ethernet (RJ-45)	3.0	Non-Shield	Out-door	
7		RS-485 (D1+, D1-)	Controller	RS-485 (D1+, D1-)	3.0	Non-Shield	In-door	
8		RS-485 (D2+~D4+, D2~-D4-)	Open	-	-	3.0	Non-Shield	In-door
		Sensor (S2~S4)		-				
		Relay Out (R2~R4, CM2~CM4)		-				
9		SD Card	SD Card	SD Card	Direct	-	-	
10		Ground	Ground	Ground	1.5	-	-	

4.5 Operating conditions

The EUT was configured as normal intended use.

Test mode	Normal operating
1	Network Encoder operating mode

5. Summary of test results

5.1 Modification to the E.U.T.

None

5.2 Summary of EMI emission test results

Application	Test method	Test result
Conducted emission - AC main port - Telecommunication port	EN 55022:2007, Class A	Complied
Radiated emission - AC main	EN 55022:2007, Class A	Complied
Harmonics current	EN 61000-3-2:2006	Complied
Voltage fluctuations and flickers	EN 61000-3-3:1995+A1:2001+A2:2005	Complied

5.3 Summary of immunity test results

Items	Application	Test method	Test result
Electrostatic discharge	Enclosure	EN 61000-4-2:1995+A1+1998+A2:2001	Complied
Radiated RF immunity	Enclosure	EN 61000-4-3:2006	Complied
Electric Fast Transient/BURST	AC main, Signal Telecommunication	EN 61000-4-4:2004	Complied
Surge	AC main, Signal	EN 61000-4-5:2006	Complied
Conducted RF immunity	AC main, Signal Telecommunication	EN 61000-4-6:2007	Complied
Voltage dip/interruption	AC main	EN 61000-4-11:2004	Complied
Voltage variation	AC main	EN 50130-4:1995+A1:1998+A2:2003	Complied

5.4 Performance criteria

The variety and the diversity of the apparatus within the scope of this document makes it difficult to define precise criteria for the evaluation of the immunity test results.

If as a result of the application of the tests defined in this standard, the apparatus becomes dangerous or unsafe then the apparatus shall be deemed to have failed the test. A functional description and a definition of performance by the manufacture and noted in the test report, based on the following criteria:

Electrostatic discharge

There shall be no damage, malfunction or change of status due to the conditioning. Flickering of an indicator during the application of discharge is permissible, providing which could be interpreted by associated equipment as a change,

Radiated electromagnetic fields

There shall be no damage, malfunction or change of status due to the conditioning. Flickering of an indicator during the application of discharge is permissible, providing which could be interpreted by associated equipment as a change, and no such Flickering of indicators occurs at a field strength of 3 V/m. For components of CCTV systems, where the picture is allowed at 10 V/m, providing.

- (a) there is no permanent damage or change to EUT (e.g. no corruption of memory or changes to programmable setting etc.)
- (b) at 3 V/m, any deterioration of the picture is so minor that the system could still be used; and
- (c) there is no observable deterioration of the picture at 1 V/m.

Fast transient burst / slow high energy voltage surge

There shall be no damage, malfunction or change of status due to the conditioning. Flickering of an indicator during the application of discharge is permissible, providing That there is no residual is permissible, providing that there is no residual change in the EUT or any change in outputs, which could be interpreted by associated equipment as

Conducted RF immunity

There shall be no damage, malfunction or change of status due to the conditioning.

Flickering of an indicator during the application of discharge is permissible, providing

That there is no residual is permissible, providing that there is no residual change in the EUT or any change in outputs, which could be interpreted by associated equipment as a change, and no such flickering of indicators oeuvres at $U = 130 \text{ dB}\mu\text{V}$.

For component of CCTV systems, where the status is monitored by observing the TV picture, then deterioration of the picture is allowed at $U = 140 \text{ dB}\mu\text{V}$, providing:

- (a) there is no permanent damage or change to the EUT (e.g. no corruption of memory or changes to programmable settings etc.):
- (b) at $U = 130 \text{ dB}\mu\text{V}$, any deterioration of the picture is so minor that the system could still be used; and
- (c) there in no observable deterioration of the picture at $U = 120 \text{ dB}\mu\text{V}$.

Voltage dip/interruption / Voltage variation

There shall be no damage, malfunction or change of status due to the conditioning.

Flickering of an indicator during the conditioning is permissible, providing that there is no residual change in the EUT or any change in outputs, which could be interpreted by associated equipment as a change. The EUT shall meet the acceptance criteria for the functional test, after the conditioning.

6. Test results

6.1 Conducted Emission

Test specification	EN 55022:2007, Section 5, Class A		
Test mode	Operating mode.		
Date	2010. 11. 10		
Testing voltage	230 V, 50 Hz		
Test facility	Shielded room (CE#1)		
Temperature (°C)	24 °C	Humidity (% R.H.)	32 % R.H.
Remarks	Complied AC main Minimum limit margin is 27.61 dB at 19.910 MHz. (Average) Telecommunication Minimum limit margin is 19.06 dB at 0.609 MHz. (Average)		

6.1.1 Limits of conducted emission measurement

- AC main

Frequency [MHz]	Class A (dB(μV))		Class B (dB(μV))	
	Quasi-peak	Average	Quasi-peak	Average
0.15 ~ 0.5	79	66	66 ~ 56 *	56 ~ 46*
0.5 ~ 5	73	60	56	46
5 ~ 30	73	60	60	50

*The limit decreases linearly with the logarithm of frequency.

- Telecommunication

Frequency [MHz]	Class A Voltage Limits (dB(μV))		Current Limits (dB(μV))	
	Quasi-Peak	Average	Quasi-Peak	Average
0.15 ~ 0.5	97 to 87	84 to 74	53 to 43	40 to 30
0.5 ~ 30	87	74	43	30

* The limits decrease linearly with the logarithm of the frequency in the range 0.15 MHz to 0.5 MHz

* The current and voltage disturbance limits are derived for use with an impedance stabilization Network (ISN) which presents a common mode (asymmetric mode) impedance of 150 Ω to the telecommunication port under test (conversion factor is $20 \log_{10} 150/I = 44$ dB).

6.1.2 Measurement procedure

The measurements were performed in a shielded room. EUT was setup as shown in photograph and placed on a non-metallic table height of 0.8 m above the reference ground plane. The rear of table was located 0.4 m to the vertical conducted plane. EUT was power through the LISN, which was bonded to the ground plane. The LISN power was filtered. Each EUT power lead, except ground (safety) lead was individually connected through a LISN to input power source. EUT signal cables that hung closer than 0.4 m to the Horizontal metal ground 0.3 m ~ 0.4 m long. The power cord was bundles in the center. All peripheral equipment was powered from a sub LISN. The LISN and ISN were positioned 0.8 m from the EUT. Peak and Average detection were used in preliminary testing and Quasi-peak and Average detections were used at final measurement.

6.1.3 Used equipments

Equipment	Model	Serial No.	Makers	Next Cal. Date	Used
Test Receiver	ESHS10	843276/003	R&S	11.06.11	<input checked="" type="checkbox"/>
LISN	NNLK8121	8121-472	SCHWARZBECK	11.07.12	<input checked="" type="checkbox"/>
LISN	L2-16A	0000J10705	PMM	-	<input checked="" type="checkbox"/>
ISN	T800	24314	TESEQ	10.12.03	<input checked="" type="checkbox"/>

6.1.4 Photographs of test setup

* AC main

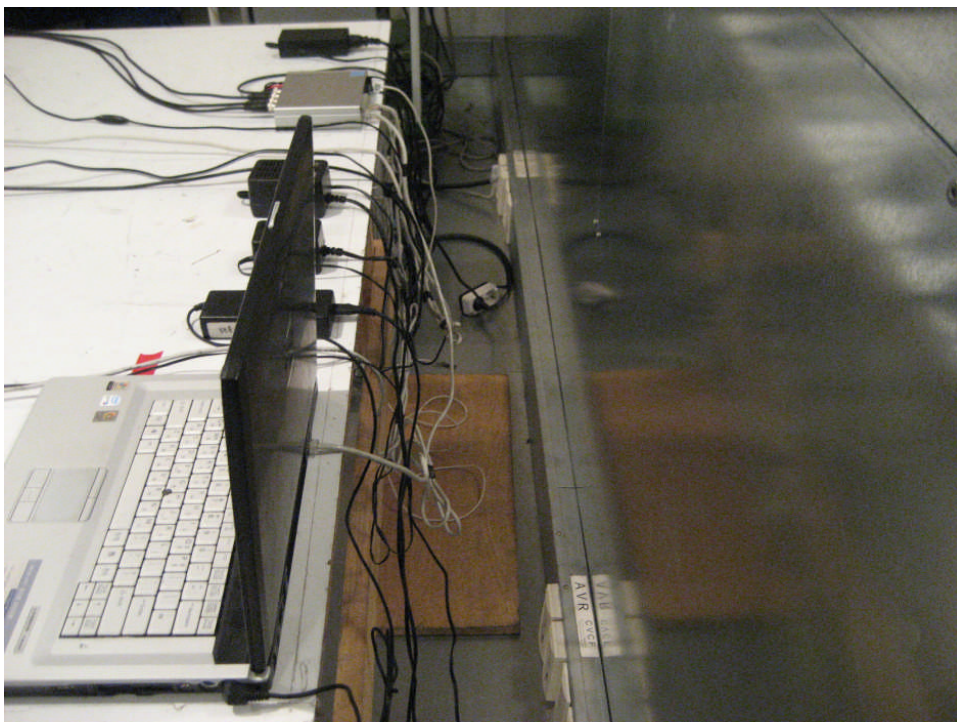
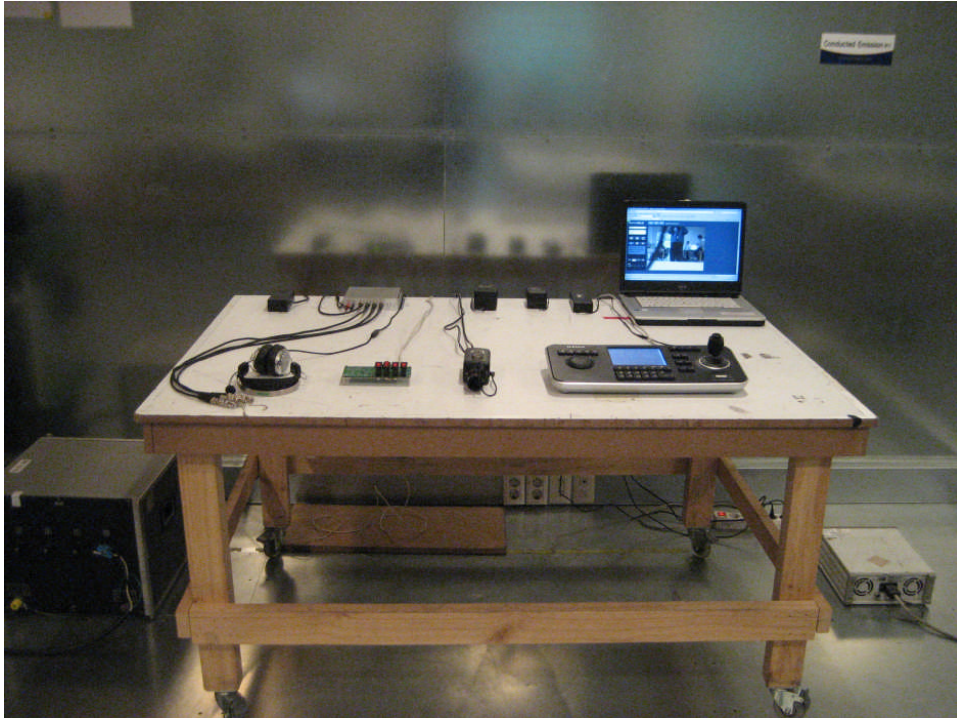

* Telecommunication

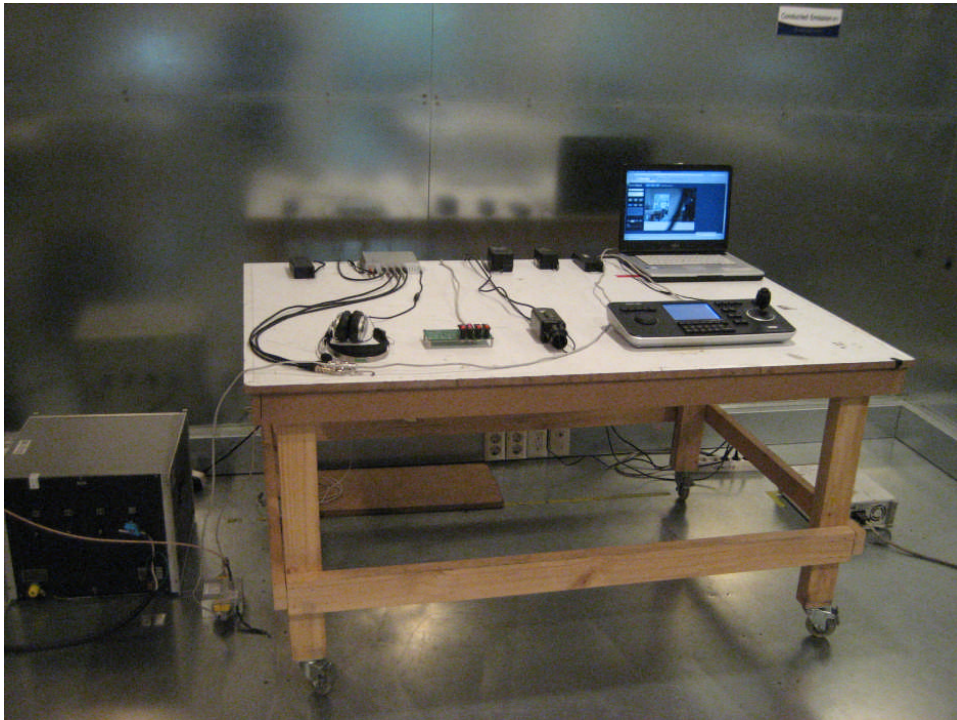

6.1.5 Conducted emission measurement result

* AC main

Frequency [MHz]	Correction Factor		Line	Quasi-peak			Average		
	LISN	Cable		Limit	Reading	Result	Limit	Reading	Result
				[dB(μ V)]	[dB(μ V)]	[dB(μ V)]	[dB(μ V)]	[dB(μ V)]	[dB(μ V)]
0.180	0.03	0.02	N	79.00	45.28	45.33	66.00	31.55	31.60
0.240	0.03	0.02	N		40.54	40.59		29.47	29.52
0.300	0.04	0.03	H		34.90	34.97		25.99	26.06
0.303	0.03	0.03	N		33.92	33.98		23.75	23.81
0.360	0.04	0.03	H		32.84	32.91		25.88	25.95
13.500	0.22	0.12	N	73.00	35.08	35.42	60.00	27.39	27.73
14.750	0.23	0.12	N		36.02	36.37		28.17	28.52
16.460	0.23	0.12	H		39.68	40.03		34.54	34.89
16.470	0.23	0.12	N		35.04	35.39		28.35	28.70
19.710	0.29	0.12	N		38.88	39.29		31.78	32.19
19.910	0.32	0.12	H		39.06	39.50		31.95	32.39

EUT: SPE-400
 Manuf:
 Op Cond: H
 Operator:
 Test Spec: EN22 Class A Conducted Emission
 Comment:
 Result File: 400ce_h.dat : SAMSUNG TECHWIN

Scan Settings (2 Ranges)

Frequencies			Receiver Settings						
Start	Stop	Step	IF BW	Detector	M-Time	Atten	Preamp	OpRge	
150kHz	3MHz	3kHz	10kHz	PK+AV	10msec	Auto	OFF	60dB	
3MHz	30MHz	10kHz	10kHz	PK+AV	5msec	Auto	OFF	60dB	

Final Measurement: Detectors: X QP / + AV
 Meas Time: 1sec
 Peaks: 8
 Acc Margin: 25 dB

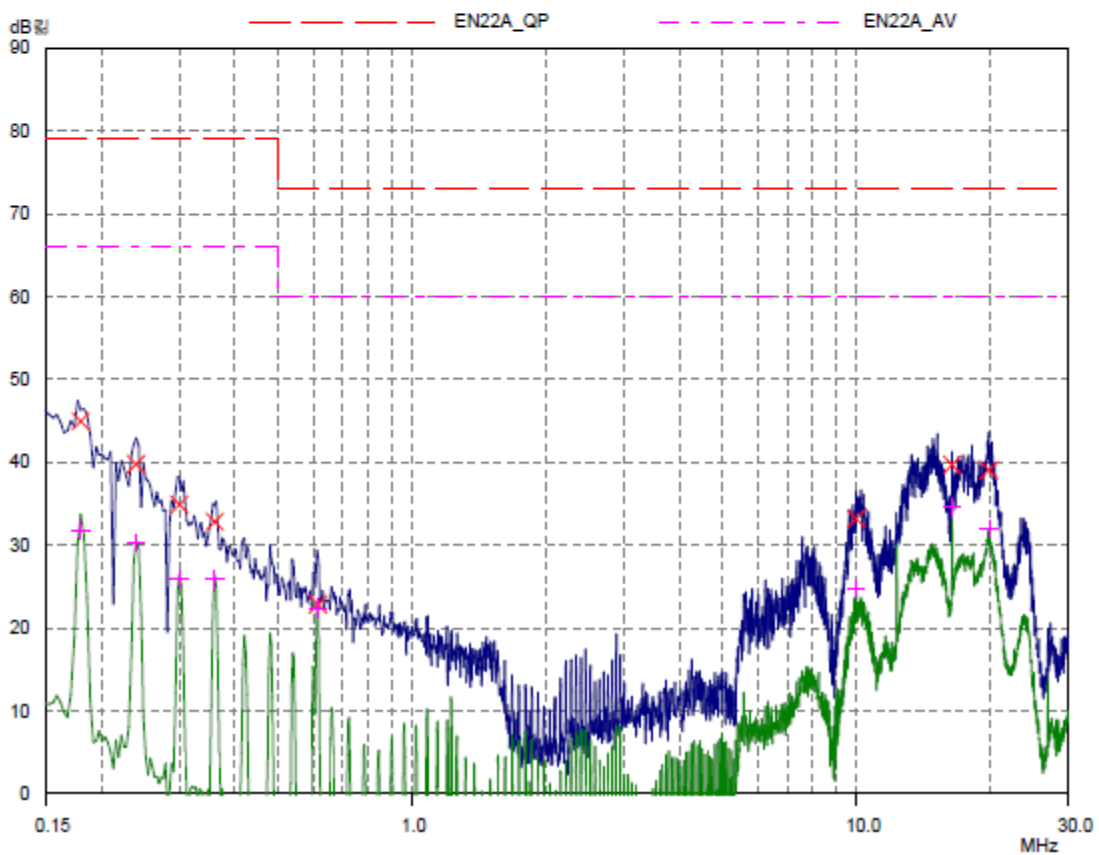

EUT: SPE-400
 Manuf:
 Op Cond: N
 Operator:
 Test Spec: EN22 Class A Conducted Emission
 Comment:

Result File: 400ce_n.dat : SAMSUNG TECHWIN

Scan Settings (2 Ranges)

Frequencies			Receiver Settings						
Start	Stop	Step	IF BW	Detector	M-Time	Atten	Preamp	OpRge	
150kHz	3MHz	3kHz	10kHz	PK+AV	10msec	Auto	OFF	60dB	
3MHz	30MHz	10kHz	10kHz	PK+AV	5msec	Auto	OFF	60dB	

Final Measurement: Detectors: X QP / + AV
 Meas Time: 1sec
 Peaks: 8
 Acc Margin: 25 dB

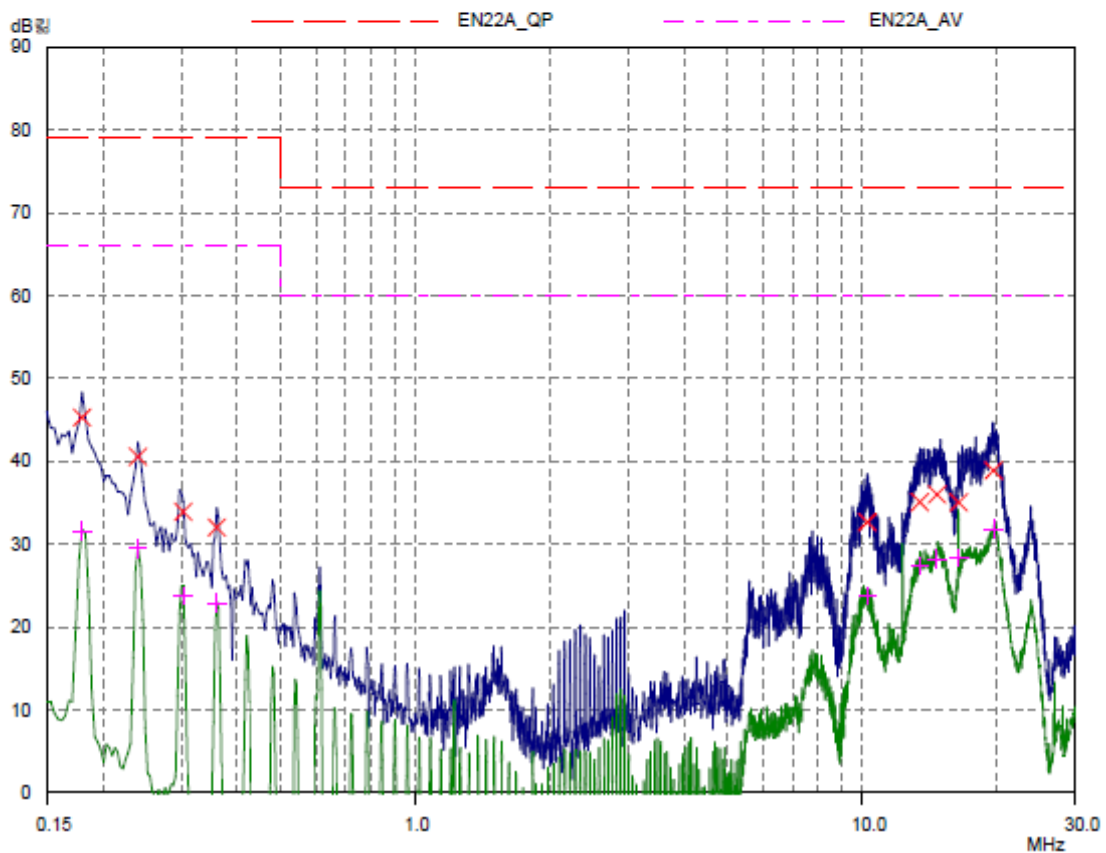

* Telecommunication port

AC main_ LCL 65 dB (LAN Port)

Frequency [MHz]	Correction	Quasi-peak			Average		
	Factor	Limit	Reading	Result	Limit	Reading	Result
	Cable	[dB(μV)]	[dB(μV)]	[dB(μV)]	[dB(μV)]	[dB(μV)]	[dB(μV)]
0.609	0.03	87.00	55.20	55.23	74.00	54.91	54.94
1.221	0.05		49.72	49.77		48.99	49.04
1.833	0.06		52.22	52.28		50.72	50.78
9.615	0.10		50.12	50.22		40.34	40.44
16.735	0.12		48.52	48.64		42.45	42.57

EUT: SPE-400
 Manuf:
 Op Cond: T
 Operator:
 Test Spec: EN55022 Class A Conducted Emission
 Comment: Telecommunication port.

Result File: 400_tel.dat : SAMSUNG TECHWIN

Scan Settings (2 Ranges)

Frequencies			Receiver Settings					
Start	Stop	Step	IF BW	Detector	M-Time	Atten	Preamp	OpRge
150kHz	3MHz	3kHz	10kHz	PK+AV	5msec	Auto	OFF	60dB
3MHz	30MHz	5kHz	10kHz	PK+AV	2msec	Auto	OFF	60dB

Transducer	No.	Start	Stop	Name
	1	10kHz	30MHz	T800

Final Measurement: Detectors: X QP / + AV
 Meas Time: 1sec
 Peaks: 8
 Acc Margin: 25 dB

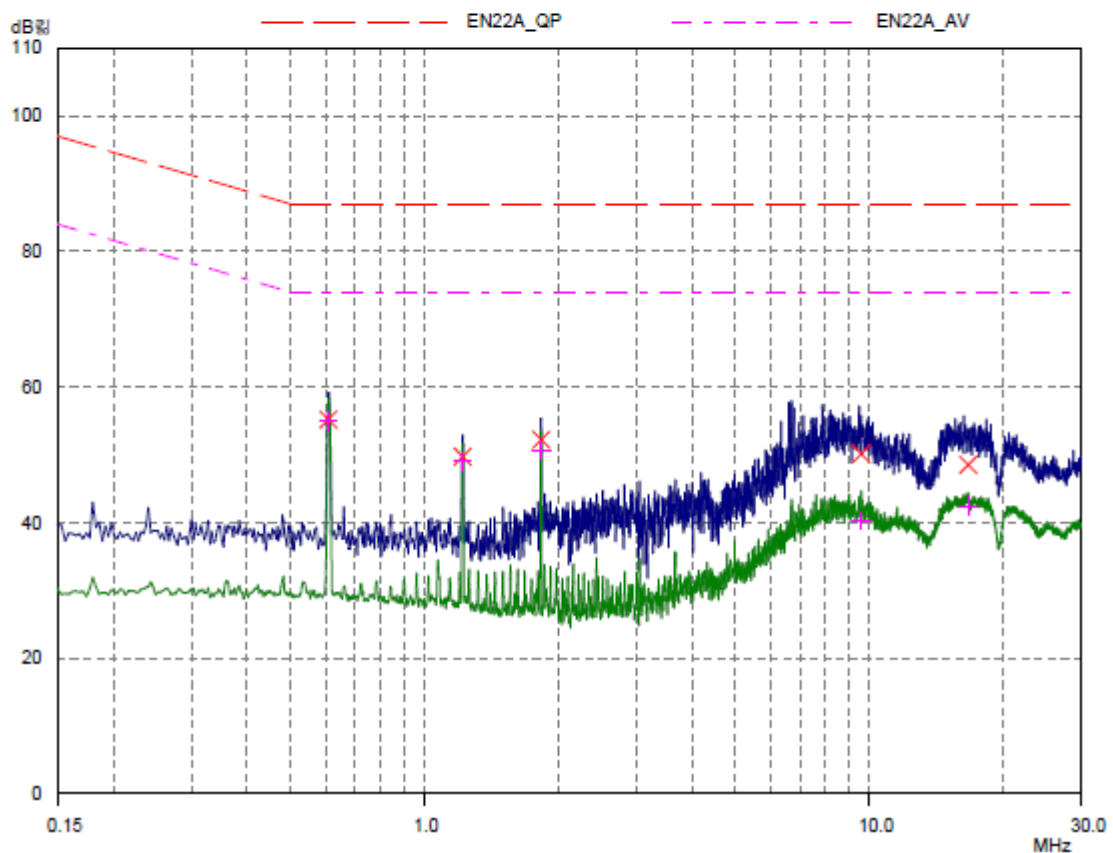

6.2 Radiated Emission

Test specification	EN 55022:2007 Sections 6, Class A		
Test mode	Operating mode.		
Date	2010. 11. 10		
Testing voltage	230 V, 50 Hz		
Test facility	10 m Chamber (Test distance: 3 m, 10 m)		
Temperature (°C)	25 °C	Humidity (% R.H.)	38 % R.H.
Remarks	Complied Minimum limit margin is 12.5 dB at 35.890 MHz. (30 MHz~1 GHz) Minimum limit margin is 21.0 dB at 1350.198 MHz. (1 GHz~6 GHz)		

6.2.1 Limits of radiated emission measurement

Frequency [MHz]	Class A (dB(μ V/m)) @ 10 m	Class B (dB(μ V/m)) @ 10 m
30 ~ 230	40	30
230 ~ 1 000	47	37

6.2.2 Measurement procedure

The test was done at a 10 m, 3 m distance at 10 m chamber with a quasi-peak detector. EUT was placed on a non-metallic table height of 0.8 m above the reference ground plane. Cables were folded back and forth forming a bundle 0.3 m to 0.4 m long and were hanged at a 0.4 m height to the ground plane. Cables connected to EUT were fixed to cause maximum emission. Test was made with the antenna positioned in both the horizontal and vertical planes of polarization. The measurement antenna was varied in height above the conducting ground plane to obtain the maximum signal strength.

6.2.3 Used equipments

Equipment	Model no.	Serial no.	Makers	Next cal. date	Used
Test Receiver	ESCI	100001	R&S	11.08.17	<input checked="" type="checkbox"/>
Bi-Log Antenna	VULB 9168	375	SCHWARZBECK	11.11.30	<input checked="" type="checkbox"/>
Amplifier	310N	284608	SONOMA INSTRUMENT	11.07.08	<input checked="" type="checkbox"/>
3 dB Attenuator	8491A	16861	HP	11.01.09	<input checked="" type="checkbox"/>
Antenna Mast	AM4.0	079/3440509	MATURO	-	<input checked="" type="checkbox"/>
Turn Table	CO2000-SOFT	-	MATURO	-	<input checked="" type="checkbox"/>
Horn ANT	3115	62589	ETS	11.12.22	<input checked="" type="checkbox"/>
Amplifier	8449B	3008A0243	AGILENT	10.11.23	<input checked="" type="checkbox"/>
Spectrum Analyzer	FSP7	100289	R&S	10.12.16	<input checked="" type="checkbox"/>

6.2.4 Sample calculation

The field strength is calculated adding the antenna Factor, cable loss and, Antenna pad adding, subtracting the amplifier gain from the measured reading.

The sample calculation is as follow:

$$\text{Result} = \text{M.R} + \text{C.F}(\text{A.F} + \text{C.L} + 3 \text{ dB Att} - \text{A.G})$$

M.R = Meter Reading

C.F = Correction Factor

A.F = Antenna Factor

C.L = Cable Loss

A.G= Amplifier Gain

3 dB Att = 3 dB Attenuator

If M.R is 30 dB, A.F 12 dB, C.L 5 dB, 3 dB, A.G 35 dB

The result is $30 + 12 + 5 + 3 - 35 = 15 \text{ dB}(\mu\text{V}/\text{m})$

6.2.5 Photographs of test setup

* 30 MHz~1 GHz

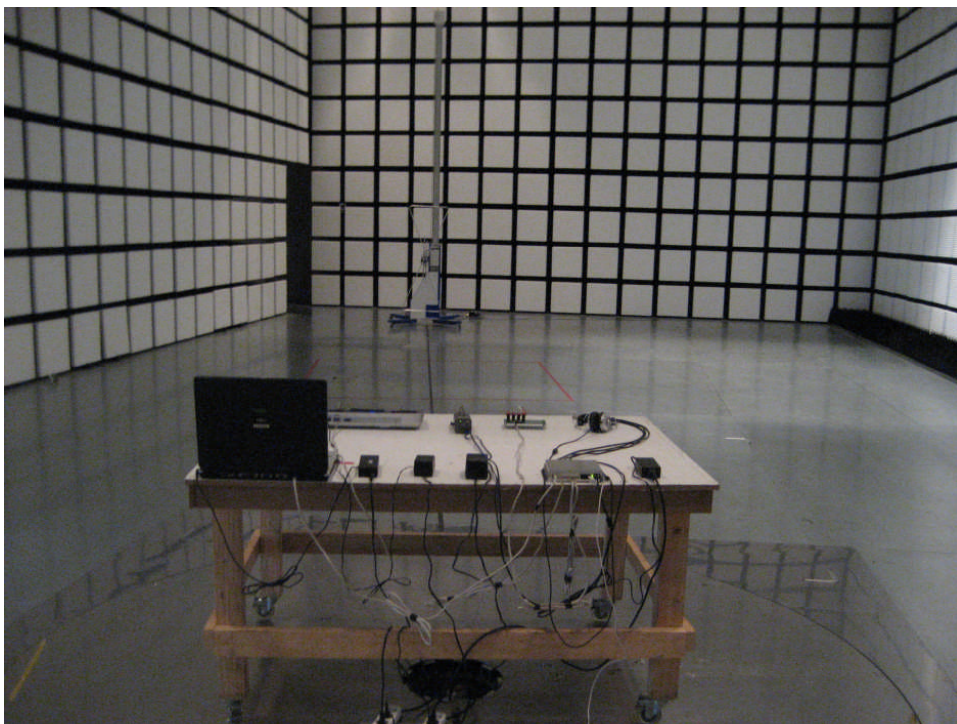
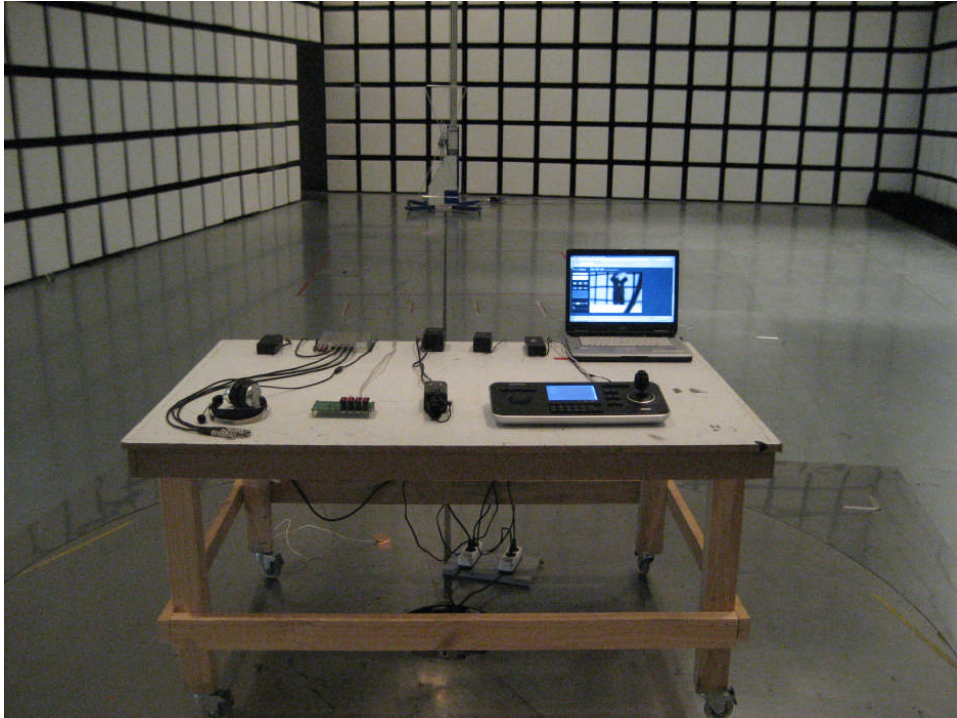

* 1 GHz ~ 6 GHz

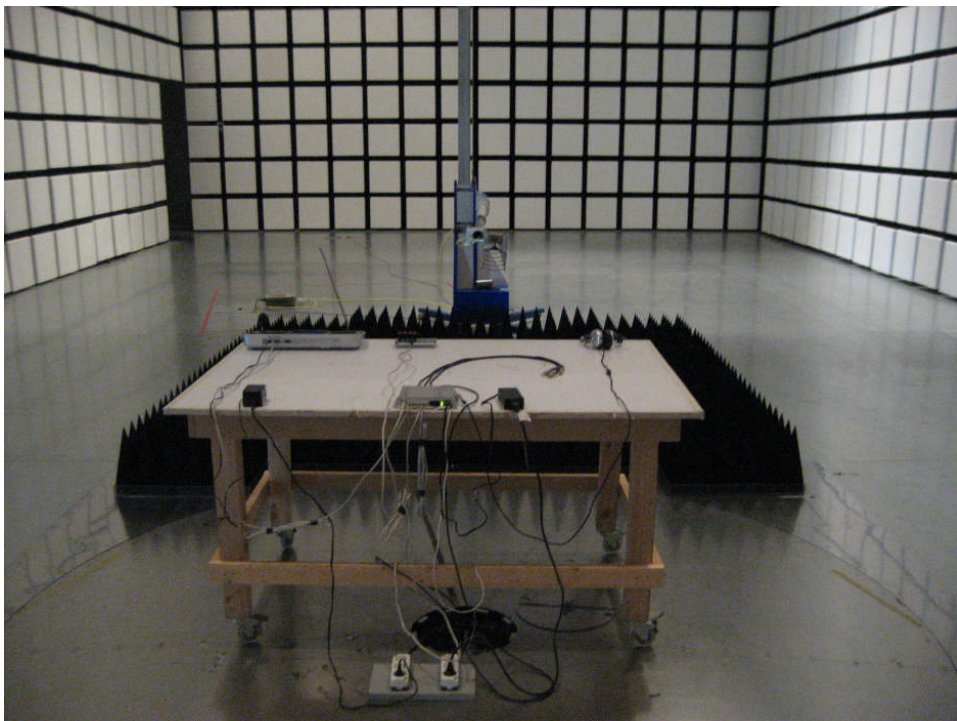
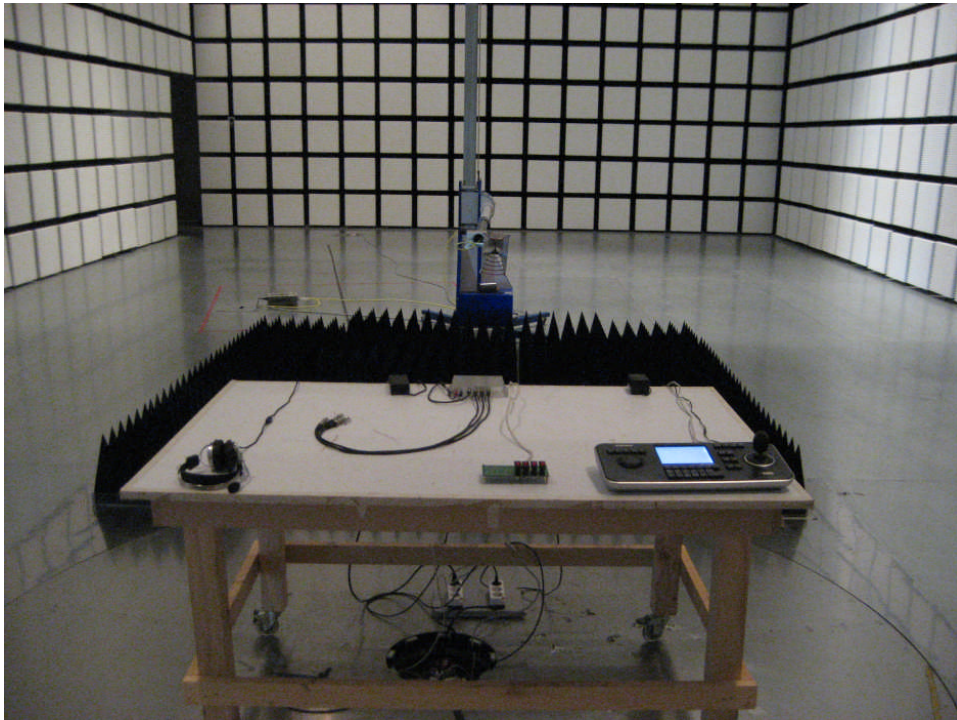

6.2.6 Radiated emission measurement result

* Graph and Data

* 30 MHz~1 GHz

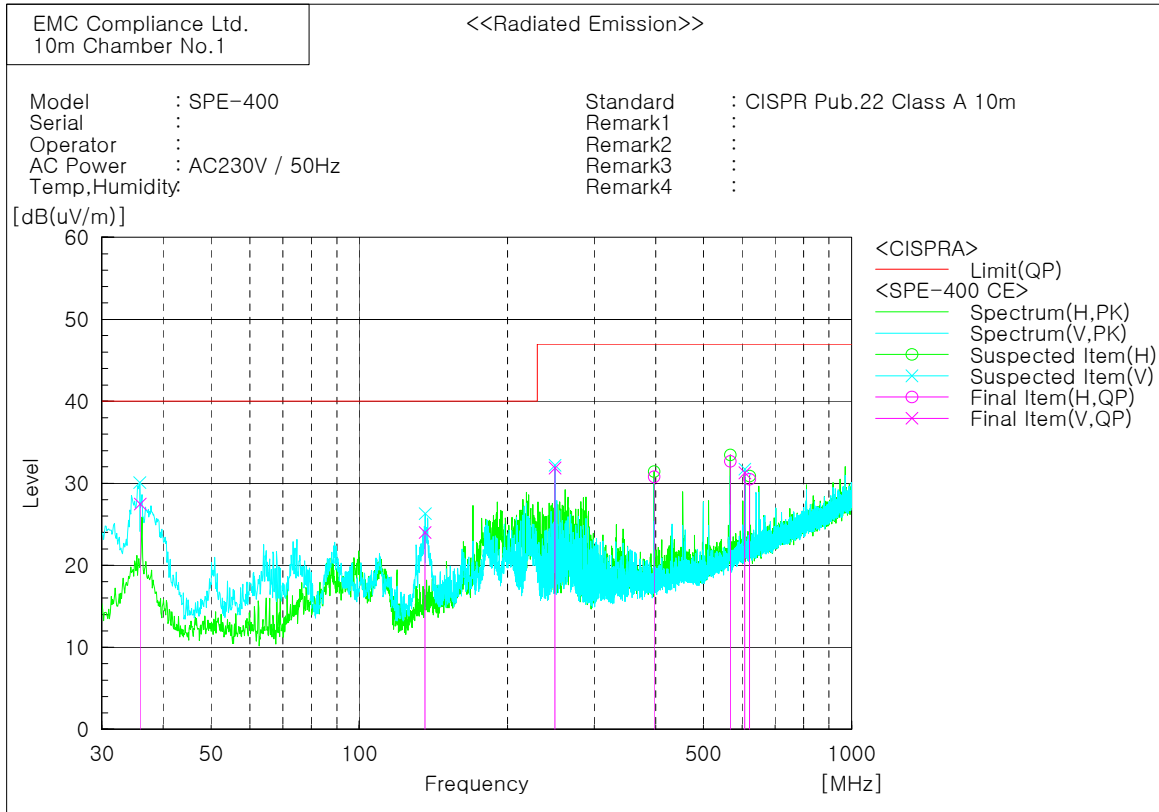

Final Result

No.	Frequency [MHz]	(P)	Reading QP [dB(uV)]	c.f [dB(1/m)]	Result QP [dB(uV/m)]	Limit QP [dB(uV/m)]	Margin QP [dB]	Height [cm]	Angle [deg]	Remark
1	35.890	V	42.2	-14.7	27.5	40.0	12.5	302.0	90.2	
2	136.010	V	37.6	-13.6	24.0	40.0	16.0	100.0	6.1	
3	250.002	V	45.5	-13.6	31.9	47.0	15.1	100.0	356.8	
4	397.250	H	39.8	-9.0	30.8	47.0	16.2	298.0	216.5	
5	567.060	H	37.5	-4.8	32.7	47.0	14.3	198.0	173.7	
6	607.230	V	35.1	-3.8	31.3	47.0	15.7	400.0	29.9	
7	621.002	H	34.1	-3.6	30.5	47.0	16.5	198.0	242.9	

* 1 GHz~6 GHz

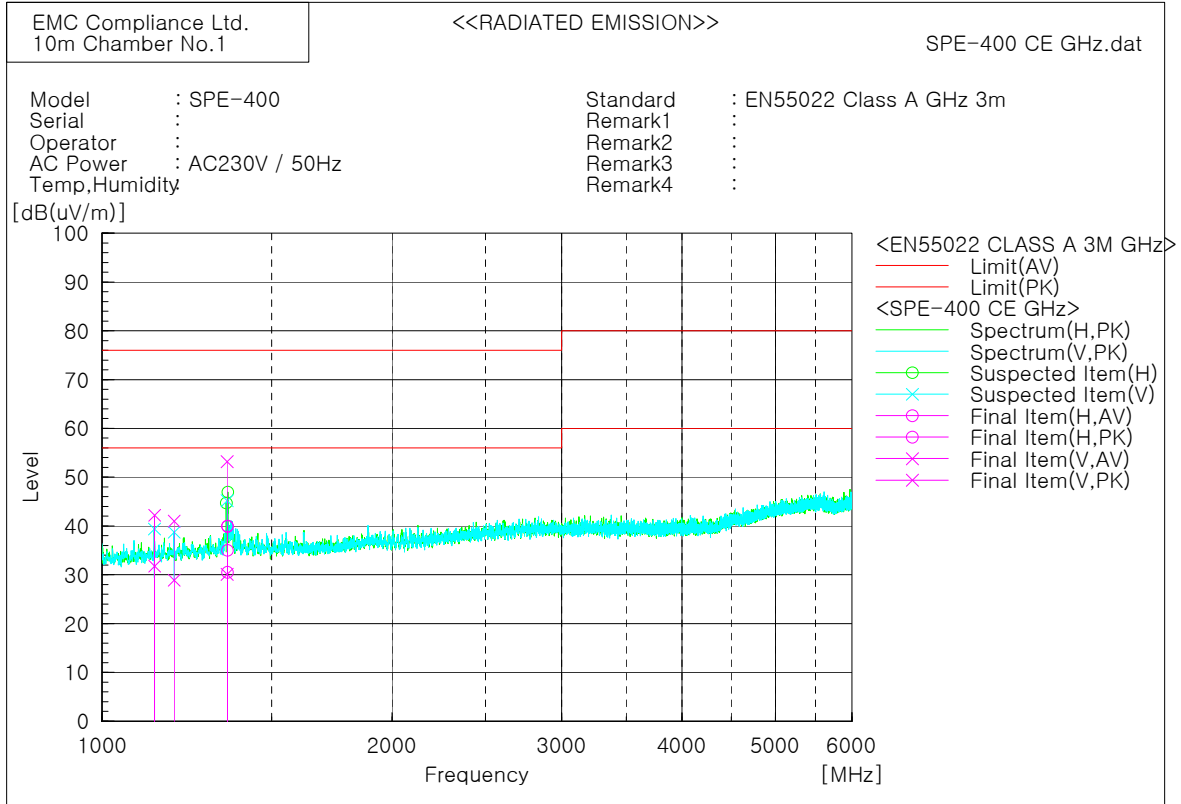

Final Result

No.	Frequency [MHz]	(P)	Reading AV [dB(uV)]	Reading PK [dB(uV)]	c. f [dB(1/m)]	Result AV [dB(uV/m)]	Result PK [dB(uV/m)]	Limit AV [dB(uV/m)]	Limit PK [dB(uV/m)]	Margin AV [dB]	Margin PK [dB]	Height [cm]	Angle [deg]
1	1134.106	V	45.7	56.1	-13.9	31.8	42.2	56.0	76.0	24.2	33.8	100.0	93.6
2	1188.125	V	42.5	54.6	-13.6	28.9	41.0	56.0	76.0	27.1	35.0	201.0	217.6
3	1349.860	H	42.9	52.4	-12.4	30.5	40.0	56.0	76.0	25.5	36.0	100.0	316.7
4	1348.183	V	42.5	65.6	-12.4	30.1	53.2	56.0	76.0	25.9	22.8	201.0	326.6
5	1350.198	H	47.4	52.3	-12.4	35.0	39.9	56.0	76.0	21.0	36.1	100.0	19.5

6.3 Harmonics

Test specification	EN 61000-3-2:2006				
Test mode	Operating mode.				
Date	2010. 11. 10				
Testing voltage	230 V , 50 Hz				
Temperature(°C)	23 °C	Humidity (% R.H.)	33 % R.H.	Pressure (kPa)	101.1 kPa
Remarks	Complied				

6.3.1 Measurement procedure

The equipment is supplied in series with shunt(s) Rm or current transformer(s) from a source having the same nominal voltage and frequency as the rated supply voltage and frequency of the equipment. Measurements shall be made under normal load, or conditions for adequate heat discharge, and under normal operating conditions. User's operation controls or automatic programmers shall be set to produce the maximum harmonic component, for each successive harmonic component in turn. For the purpose of harmonic current limitation, equipment is classified as follows :

Class A : Equipment not specified in one of the three other Classes shall be considered as Class A equipment.

- Balanced three-phase equipment;
- Household appliances excluding equipment identified as Class D;
- Tools excluding portable tools;
- Dimmers for incandescent lamps;
- Audio equipment.

Class B : Portable tools; Arc welding equipment which is not professional equipment.

Class C : Lighting equipment.

Class D : Equipment having a specified power according to 6.2.2 less than or equal to 600 w, of the following types:

- Personal computers and personal computer monitors;
- Television receivers.

6.3.2 Used equipments

Equipment	Model no.	Serial no.	Makers	Next Cal. date	Used
Harmonics/Flicker meter	5001x-CTS-400-413	54984	C.I.	11.05.24	<input checked="" type="checkbox"/>

6.3.3 Photographs of test setup



6.3.4 Measurement result

Harmonics – Class-A per Ed. 3.0 (2005-11)(Run time) incl. inter-harmonics

EUT: SPE-400
 Test category: Class-A per Ed. 3.0 (2005-11) (European limits)
 Test date: 2010-11-10 Start time: 오전 9:44:08 End time: 오전 9:46:57
 Test duration (min): 2.5 Data file name: H-000350.cts_data
 Comment: Comments
 Customer: SAMSUNG TECHWIN CO.,LTD

Tested by: EMC Compliance
 Test Margin: 100

Test Result: Pass Source qualification: Normal

Current & voltage waveforms

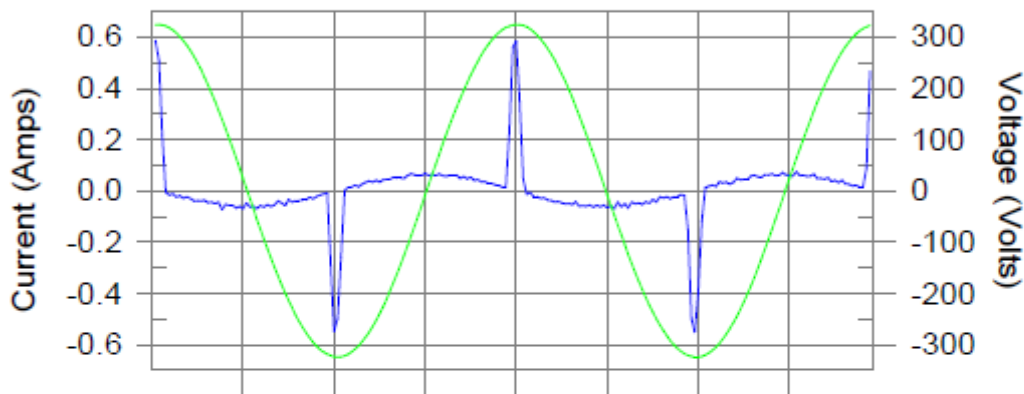

Harmonics and Class A limit line European Limits

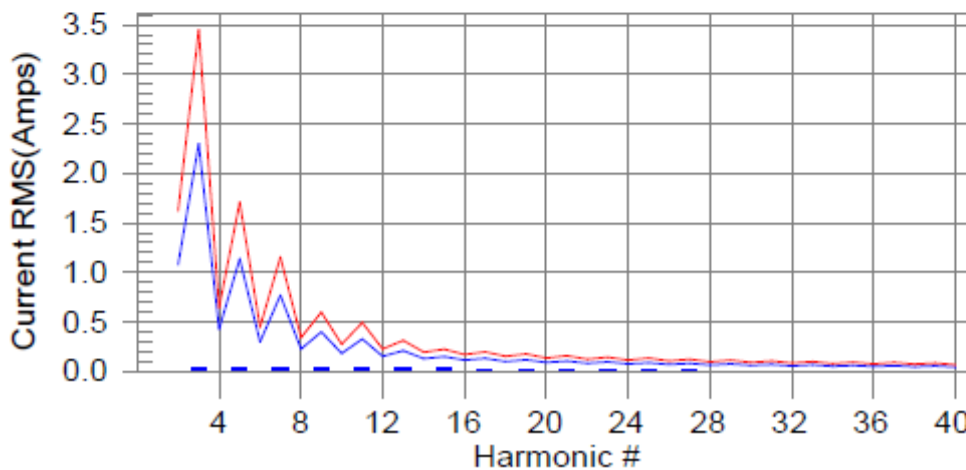

Test result: Pass Worst harmonic was #15 with 18.79% of the limit.

Current Test Result Summary (Run time)

EUT: SPE-400 Tested by: EMC Compliance
Test category: Class-A per Ed. 3.0 (2005-11) (European limits) Test Margin: 100
Test date: 2010-11-10 Start time: 오전 9:44:08 End time: 오전 9:46:57
Test duration (min): 2.5 Data file name: H-000350.cts_data
Comment: Comments
Customer: SAMSUNG TECHWIN CO.,LTD

Test Result: Pass Source qualification: Normal
THC(A): 0.11 I-THD(%): 173.72 POHC(A): 0.027 POHC Limit(A): 0.251

Highest parameter values during test:

V_RMS (Volts): 229.54 Frequency(Hz): 50.00
I_Peak (Amps): 0.621 I_RMS (Amps): 0.130
I_Fund (Amps): 0.063 Crest Factor: 4.891
Power (Watts): 10.7 Power Factor: 0.360

Harm#	Harms(avg)	100%Limit	%of Limit	Harms(max)	150%Limit	%of Limit	Status
2	0.001	1.080	0.1	0.002	1.620	0.11	Pass
3	0.043	2.300	1.9	0.045	3.450	1.31	Pass
4	0.001	0.430	0.3	0.002	0.645	0.28	Pass
5	0.042	1.140	3.6	0.044	1.710	2.55	Pass
6	0.001	0.300	0.4	0.001	0.450	0.32	Pass
7	0.040	0.770	5.2	0.042	1.155	3.60	Pass
8	0.001	0.230	0.5	0.002	0.345	0.44	Pass
9	0.037	0.400	9.4	0.039	0.600	6.52	Pass
10	0.001	0.184	0.6	0.001	0.276	0.46	Pass
11	0.035	0.330	10.5	0.036	0.495	7.30	Pass
12	0.001	0.153	0.7	0.001	0.230	0.58	Pass
13	0.032	0.210	15.0	0.033	0.315	10.42	Pass
14	0.001	0.131	0.7	0.001	0.197	0.56	Pass
15	0.028	0.150	18.8	0.029	0.225	12.96	Pass
16	0.001	0.115	0.7	0.001	0.173	0.56	Pass
17	0.025	0.132	18.7	0.025	0.199	12.77	Pass
18	0.001	0.102	0.7	0.001	0.153	0.58	Pass
19	0.021	0.118	17.8	0.022	0.178	12.15	Pass
20	0.001	0.092	0.7	0.001	0.138	0.53	Pass
21	0.017	0.107	16.3	0.018	0.161	11.14	Pass
22	0.001	0.084	0.7	0.001	0.125	0.55	Pass
23	0.014	0.098	14.4	0.014	0.147	9.80	Pass
24	0.001	0.077	0.7	0.001	0.115	0.55	Pass
25	0.011	0.090	12.1	0.011	0.135	8.23	Pass
26	0.000	0.071	0.6	0.001	0.106	0.54	Pass
27	0.008	0.083	9.5	0.008	0.125	6.58	Pass
28	0.000	0.066	0.8	0.001	0.099	0.63	Pass
29	0.005	0.078	7.0	0.006	0.116	5.00	Pass
30	0.000	0.061	0.7	0.001	0.092	0.56	Pass
31	0.003	0.073	4.7	0.004	0.109	3.46	Pass
32	0.001	0.058	0.9	0.001	0.086	0.76	Pass
33	0.002	0.068	2.8	0.002	0.102	2.09	Pass
34	0.000	0.054	0.9	0.001	0.081	0.70	Pass
35	0.001	0.064	2.3	0.002	0.096	1.84	Pass
36	0.000	0.051	0.8	0.001	0.077	0.74	Pass
37	0.002	0.061	3.5	0.003	0.091	2.76	Pass
38	0.000	0.048	0.9	0.001	0.073	0.75	Pass
39	0.003	0.058	4.7	0.003	0.087	3.56	Pass
40	0.000	0.046	0.8	0.000	0.069	0.61	Pass

Voltage Source Verification Data (Run time)

EUT: SPE-400 Tested by: EMC Compliance
Test category: Class-A per Ed. 3.0 (2005-11) (European limits) Test Margin: 100
Test date: 2010-11-10 Start time: 오전 9:44:08 End time: 오전 9:46:57
Test duration (min): 2.5 Data file name: H-000350.cts_data
Comment: Comments
Customer: SAMSUNG TECHWIN CO.,LTD

Test Result: Pass Source qualification: Normal

Highest parameter values during test:

Voltage (Vrms): 229.54	Frequency(Hz): 50.00
I_Peak (Amps): 0.621	I_RMS (Amps): 0.130
I_Fund (Amps): 0.063	Crest Factor: 4.891
Power (Watts): 10.7	Power Factor: 0.360

Harm#	Harmonics	V-rms	Limit V-rms	% of Limit	Status
2		0.100	0.459	21.70	OK
3		0.577	2.066	27.95	OK
4		0.021	0.459	4.57	OK
5		0.018	0.918	1.97	OK
6		0.024	0.459	5.33	OK
7		0.015	0.689	2.16	OK
8		0.019	0.459	4.18	OK
9		0.031	0.459	6.80	OK
10		0.006	0.459	1.25	OK
11		0.021	0.230	9.25	OK
12		0.026	0.230	11.39	OK
13		0.042	0.230	18.37	OK
14		0.004	0.230	1.96	OK
15		0.020	0.230	8.77	OK
16		0.018	0.230	7.99	OK
17		0.023	0.230	9.85	OK
18		0.012	0.230	5.12	OK
19		0.025	0.230	10.91	OK
20		0.007	0.230	3.24	OK
21		0.014	0.230	5.96	OK
22		0.004	0.230	1.56	OK
23		0.014	0.230	5.98	OK
24		0.007	0.230	3.17	OK
25		0.010	0.230	4.18	OK
26		0.008	0.230	3.40	OK
27		0.015	0.230	6.45	OK
28		0.010	0.230	4.26	OK
29		0.003	0.230	1.26	OK
30		0.012	0.230	5.04	OK
31		0.012	0.230	5.26	OK
32		0.008	0.230	3.63	OK
33		0.008	0.230	3.69	OK
34		0.009	0.230	3.90	OK
35		0.008	0.230	3.43	OK
36		0.008	0.230	3.28	OK
37		0.010	0.230	4.35	OK
38		0.003	0.230	1.50	OK
39		0.006	0.230	2.79	OK
40		0.011	0.230	4.81	OK

6.4 Flicker

Test specification	EN 61000-3-3:1995+A1:2001+A2:2005				
Test mode	Operating mode.				
Date	2010. 11. 10				
Testing voltage	230 V, 50 Hz				
Temperature(°C)	23 °C	Humidity (% R.H.)	33 % R.H.	Pressure (kPa)	101.1 kPa
Remarks	Complied				

6.4.1 Measurement procedure

EUT was connected to the power analyzer system.

Measurement was performed to obtain the desired flicker parameters.

The measuring time depends on which parameters are to be measured.

$$P_{lt} = 2 \text{ h}$$

$$P_{st} = 10 \text{ min}$$

Controls and automatic programs shall be set to produce the most unfavorable sequence of voltage changes, using only those combinations of controls and programs are mentioned by the manufacturer in the instruction manual.

6.4.2 Used equipments

Equipment	Model no.	Serial no.	Makers	Next Cal. date	Used
Harmonics/Flicker meter	5001x-CTS-400-413	54984	C.I.	11.05.24	<input checked="" type="checkbox"/>

6.4.3 Photographs of test setup



6.4.4 Measurement result

Flicker Test Summary per EN/IEC61000-3-3 (Run time)

EUT: SPE-400
 Test category: All parameters (European limits)
 Test date: 2010-11-10
 Test duration (min): 10
 Comment: Comments
 Customer: SAMSUNG TECHWIN CO.,LTD

Tested by: EMC Compliance
 Test Margin: 100
 Start time: 오전 9:48:50
 End time: 오전 9:59:11
 Data file name: F-000351.cts_data

Test Result: Pass Status: Test Completed

Pst_i and limit line European Limits



Plt and limit line

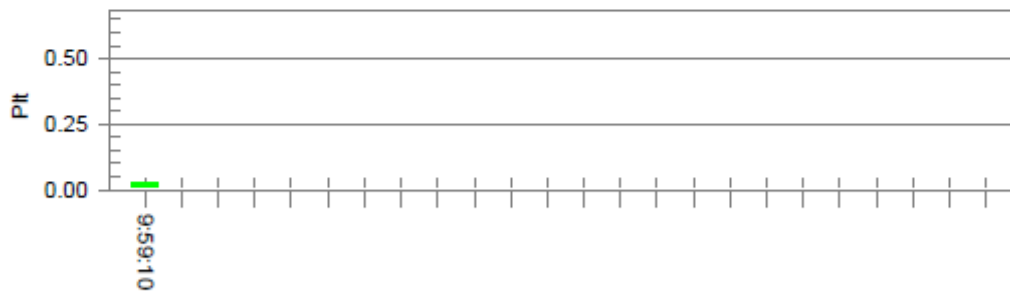

Parameter values recorded during the test:

Vrms at the end of test (Volt):	229.48		
Highest dt (%):	0.00	Test limit (%):	3.30 Pass
Time(mS) > dt:	0.0	Test limit (mS):	500.0 Pass
Highest dc (%):	0.00	Test limit (%):	3.30 Pass
Highest dmax (%):	0.00	Test limit (%):	4.00 Pass
Highest Pst (10 min. period):	0.064	Test limit:	1.000 Pass
Highest Plt (2 hr. period):	0.028	Test limit:	0.650 Pass

6.5 Electrostatic Discharge

Test specification	EN 61000-4-2:1995+A1+1998+A2:2001				
Test level	Contact: ± 2, 4, 6 kV Air: ± 2, 4, 8 kV HCP / VCP: ± 2, 4, 6 kV				
Discharge impedance	330 Ω / 150 pF				
Testing voltage	230 V, 50 Hz				
Date	2010. 11. 13				
Number of discharge (Each polarity)	10				
Interval between discharges	1 s				
Temperature(°C)	20 °C	Humidity (% R.H.)	35 % R.H.	Pressure (kPa)	101.0 kPa
Remarks	Complied - There was no change of operation status during above testing.				

6.5.1 Measurement procedure

A ground reference plane was located on the floor, and connected to earth via a low Impedance connection. The return cable of the ESD generator was connected to the reference plane. In case of floor standing equipment, EUT was placed on the reference plane on 0.1 m of insulating Support. In case of table top equipment, EUT was placed on a wooden table 0.8 m above the reference grounded floor. A horizontal coupling plane (HCP) was placed on the table, and Connected to the reference plane via a 470 kΩ resistor located in each end (0.5 mm insulating support between EUT and HCP). In both cases a vertical coupling plane(VCP) OF 0.5 X 0.5 m was located 0.1 m from the EUT's sides. The VCP was connected to the reference plane in the same matter as the HCP.



6.5.2 Used equipments

Equipment	Model No.	Serial No.	Makers	Next Cal. Date	Used
ESD Tester	NSG 437	182	TESEQ	11.05.27	<input checked="" type="checkbox"/>
HCP	-	-	-	-	<input checked="" type="checkbox"/>
VCP	-	-	-	-	<input checked="" type="checkbox"/>

6.5.3 Photographs of test setup



6.5.4 Measurement result
Electrostatic Discharge (Test Point)

Air discharge	
Contact discharge	

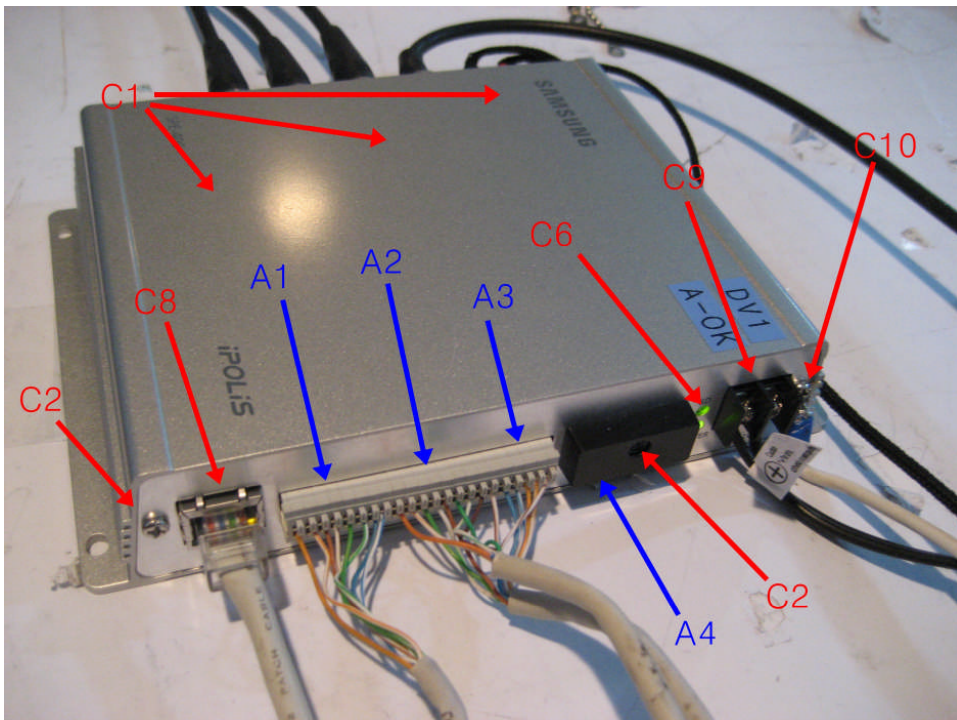
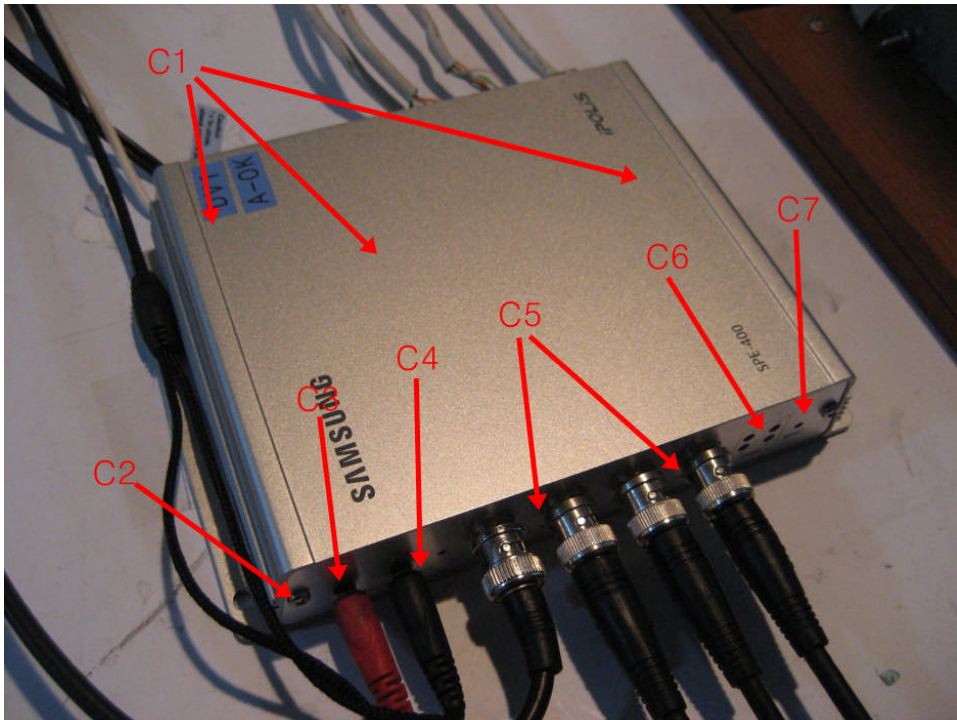

Contact discharge

Location(EUT)		Applied level (\pm)	Result
C1	Case(Enclosure)	$\pm 2, 4, 6$ kV	Complied
C2	Screw	$\pm 2, 4, 6$ kV	Complied
C3	Audio In Port	$\pm 2, 4, 6$ kV	Complied
C4	Audio Out Port	$\pm 2, 4, 6$ kV	Complied
C5	Video In Port	$\pm 2, 4, 6$ kV	Complied
C6	LED	$\pm 2, 4, 6$ kV	Complied
C7	Reset Button	$\pm 2, 4, 6$ kV	Complied
C8	Ethernet Port	$\pm 2, 4, 6$ kV	Complied
C9	Power Port	$\pm 2, 4, 6$ kV	Complied
C10	Ground	$\pm 2, 4, 6$ kV	Complied
	HCP (All 4 sides)	$\pm 2, 4, 6$ kV	Complied
	VCP (All 4 sides)	$\pm 2, 4, 6$ kV	Complied

Air discharge

Location(EUT)		Applied level (\pm)	Result
A1	RS-485 Port	$\pm 2, 4, 8$ kV	Complied
A2	Sensor Port	$\pm 2, 4, 8$ kV	Complied
A3	Relay Out Port	$\pm 2, 4, 8$ kV	Complied
A4	SD Card Cap	$\pm 2, 4, 8$ kV	Complied

6.6 Radio Frequency Electromagnetic Fields

Test specification	EN 61000-4-3:2006				
Tested frequency	80 MHz ~ 1 GHz, 1 GHz ~ 2 GHz log 1 % step				
Test level & Modulation	1, 3, 10 V/m, 80 % Amplitude Modulation (1 kHz) 1, 3, 10 V/m, Pulse Modulation (1 Hz (0.5 s ON: 0.5 s OFF))				
Distance	3 m from EUT to tip of antenna				
Dwell time	3 s				
Step size	log 1 % step				
Testing voltage	230 V, 50 Hz				
Date	2010. 11. 12				
Temperature(°C)	23 °C	Humidity (% R.H.)	33 % R.H.	Pressure (kPa)	100.9 kPa
Remarks	Complied - There was no change of operation status during above testing.				

6.6.1 Measurement procedure

The test was performed at 3 m full anechoic chamber.

For floor standing equipment, the EUT was standing on the floor.

For tabletop equipment, the EUT was located on a wooden table 0.8 m above the floor.

The EUT was tested all sides, horizontal and vertical polarization.

6.6.2 Used equipments

Equipment	Model no.	Serial no.	Makers	Next Cal. date	Used
Power meter	PM2002	302852	AR	11.04.19	<input checked="" type="checkbox"/>
Power sensor	PH2000	303224	AR	11.04.16	<input checked="" type="checkbox"/>
Power sensor	PH2000	303222	AR	11.04.16	<input checked="" type="checkbox"/>
Directional coupler	DC6180	303976	AR	11.04.16	<input checked="" type="checkbox"/>
Directional coupler	DC7144M1	320279	AR	11.02.22	<input checked="" type="checkbox"/>
Signal generator	E4421B	GB40052295	AGILENT	11.10.25	<input checked="" type="checkbox"/>
Amplifier	150W1000M2	303843	AR	11.04.19	<input checked="" type="checkbox"/>
Amplifier	60S1G3M2	320444	AR	11.04.19	<input checked="" type="checkbox"/>
Broadband Ant.	LPDA-0803	130269	ETS	-	<input checked="" type="checkbox"/>
Field monitor	SI-300	-	TDK	-	<input checked="" type="checkbox"/>
Antenna master	-	-	ETS	-	<input checked="" type="checkbox"/>

6.6.3 Photographs of test setup

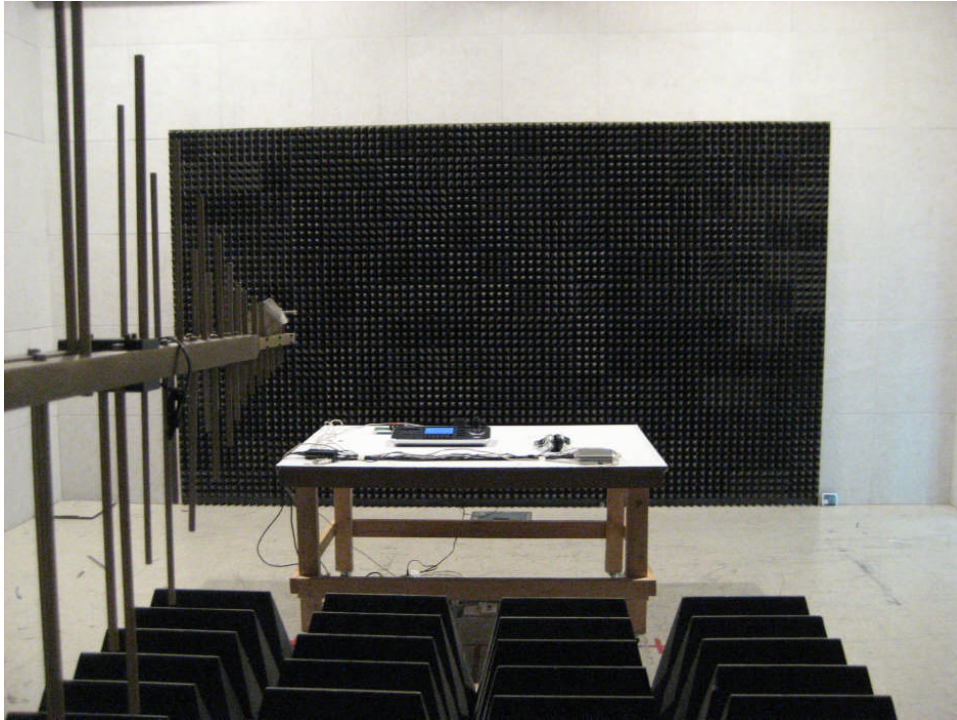

6.6.4 Measurement result

Location(EUT)	Antenna polarization	Result
Front side	Horizontal	Complied
	Vertical	Complied
Rear side	Horizontal	Complied
	Vertical	Complied
Left side	Horizontal	Complied
	Vertical	Complied
Right side	Horizontal	Complied
	Vertical	Complied

6.7 Electric Fast Transient/BURST

Test specification	EN 61000-4-4:2004				
Coupling	AC main Signal: Clamp Telecommunication : Clamp				
Test level	AC main: ± 2 kV Peak Signal: ± 1 kV Peak Telecommunication: ± 1 kV Peak				
Repetition frequency	5 kHz, Tr/Th = 5 / 50 ns				
Coupling time	60 s				
Testing voltage	230 V, 50 Hz				
Date	2010. 11. 13				
Temperature(°C)	21 °C	Humidity (% R.H.)	32 % R.H.	Pressure (kPa)	101.0 kPa
Remarks	Complied - There was no change of operation status during above testing.				

6.7.1 Measurement procedure

A ground reference plane was located on the floor.

EFT generator was connected to reference ground plane via low impedance connection.

For floor standing equipment, EUT was placed on a 0.1 m wooden table.

For tabletop equipment, EUT was placed on a 0.1 m above the ground reference plane.

Test generator and coupling/decoupling network was placed on, and bounded to, the ground reference plane. When using the coupling clamp, the minimum distance between the coupling plates and all other conductive surfaces, except the ground reference plane beneath the coupling clamp, Shall be 0.5 m.

6.7.2 Used equipments

Equipment	Model No.	Serial No.	Makers	Next Cal. date	Used
Generator	UCS 500 M6	V0545100858	EM TEST	11.02.02	<input checked="" type="checkbox"/>
Capacitive Coupling Clamp	-	-	EM TEST	-	<input checked="" type="checkbox"/>

6.7.3 Photographs of test setup



6.7.4 Measurement result

EFT coupling point	(+)	(-)	Result
L+N+PE	+ 2 kV	- 2 kV	Complied

* Signal

EFT coupling point	(+)	(-)	Result
Video In (BNC)	+ 1 kV	- 1 kV	Complied
RS-485	+ 1 kV	- 1 kV	Complied
Sensor	+ 1 kV	- 1 kV	Complied
Relay Out	+ 1 kV	- 1 kV	Complied

* Telecommunication

EFT coupling point	(+)	(-)	Result
Ethernet(RJ-45)	+ 1 kV	- 1 kV	Complied

6.8 Surge

Test specification	EN 61000-4-5:2006				
Coupling	AC Main, Signal(Video In (BNC)) : Direct Signal(RS-485, Sensor, Relay Out): CDN				
Test level	AC main Differential mode: $\pm 0.5, 1$ kV Common mode: $\pm 0.5, 1, 2$ kV Signal: $\pm 0.5, 1$ kV				
Surge pulse shape	Tr/Th = 1.2 / 50 μ s				
Coupling Impedance	AC main Differential mode: 18 μ F Common mode: 10 Ω + 9 μ F Signal(RS-485, Sensor, Relay Out): 40 Ω Signal (Video In (BNC)) : Direct				
Number of surge & Coupling time	5 / 1 min				
Angles	0 °, 90 °, 180 °, 270 °				
Testing voltage	230 V, 50 Hz				
Date	2010. 11. 13				
Temperature(°C)	21 °C	Humidity (% R.H.)	32 % R.H.	Pressure (kPa)	101.0 kPa
Remarks	Complied - There was no change of operation status during above testing.				

6.8.1 Measurement procedure

A ground reference plane was located on the floor. SURGE generator was connected to reference ground plane via low impedance connection. For floor standing equipment & table top equipment, EUT was placed on a wooden table.

6.8.2 Used equipments

Equipment	Model No.	Serial No.	Makers	Next Cal. date	Used
Generator	UCS 500 M6	V0545100858	EM TEST	11.02.02	<input checked="" type="checkbox"/>
CDN	CNV 508	1001-10	EM TEST	-	<input checked="" type="checkbox"/>

6.8.3 Photographs of test setup



6.8.4 Measurement result

Coupling point	(+)	(-)	Result
L-N	+ 0.5, 1 kV	- 0.5, 1 kV	Complied
L-PE	+ 0.5, 1, 2 kV	- 0.5, 1, 2 kV	Complied
N-PE	+ 0.5, 1, 2 kV	- 0.5, 1, 2 kV	Complied

* Signal

Coupling point	(+)	(-)	Result
Video In (BNC)	+ 0.5, 1 kV	- 0.5, 1 kV	Complied
RS-485	+ 0.5, 1 kV	- 0.5, 1 kV	Complied
Sensor	+ 0.5, 1 kV	- 0.5, 1 kV	Complied
Relay Out	+ 0.5, 1 kV	- 0.5, 1 kV	Complied

6.9 Conducted Immunity

Test specification	EN 61000-4-6:2007				
Tested frequency	0.15 MHz ~ 100 MHz log 1 % step				
Test level & Modulation	1, 3, 10 V, 80 % Amplitude Modulation (1 kHz) 1, 3, 10 V, Pulse Modulation (1 Hz (0.5 s ON: 0.5 s OFF))				
Coupling method	AC main: M3 (CDN) Signal(RS-485, Sensor, Relay Out): Clamp Signal(Video In (BNC)) : CDN(S1/75) Telecommunication: Clamp				
Testing voltage	230 V, 50 Hz				
Date	2010. 11. 09				
Temperature(°C)	23 °C	Humidity (% R.H.)	33 % R.H.	Pressure (kPa)	100.9 kPa
Remarks	<p>Complied</p> <p>AC Main</p> <p>- There was no change of operation status during above testing. (1 V, 3 V, 10 V)</p> <p>Signal, Telecommunication</p> <p>- There was no change of operation status during above testing. (1 V, 3 V, 10 V)</p>				

6.9.1 Measurement procedure

A ground reference plane was located on the floor.

The test was performed on a ground reference plane on a 0.1 m wooden table.

This test were performed using CDN for mains, clamp for signal and injection probe.

The frequency range was swept from 0.15 MHz to 100 MHz. This frequency range was Modulated with 1 kHz sine wave at 80 %.

The signal generators provided the modulated frequency at a 1 % step size.

The power and all network cable, I/O cables longer than 3 m length were tested.

6.9.2 Used equipments

Equipment	Model no.	Serial no.	Makers	Next Cal. date	Used
CS generator	CWS 500 C S1	V0635101750	EM TEST	11.10.13	<input checked="" type="checkbox"/>
CDN	CDN M2/M3	0906-12	EM TEST	11.10.13	<input checked="" type="checkbox"/>
CDN	CDN M3-32A	0506-29	EM TEST	11.02.10	<input checked="" type="checkbox"/>
CDN	CDN S1/75	0410-28	EM TEST	11.04.30	<input checked="" type="checkbox"/>
Attenuator	73-6-34	MU918	MCE/WEINSCHEL	11.10.13	<input checked="" type="checkbox"/>
EM Clamp	KEMZ 801	17643	Schaffner	11.04.19	<input checked="" type="checkbox"/>
Current probe	MD720	W1345167/M6/0068	Schaffner	-	<input type="checkbox"/>

6.9.3 Photographs of test setup

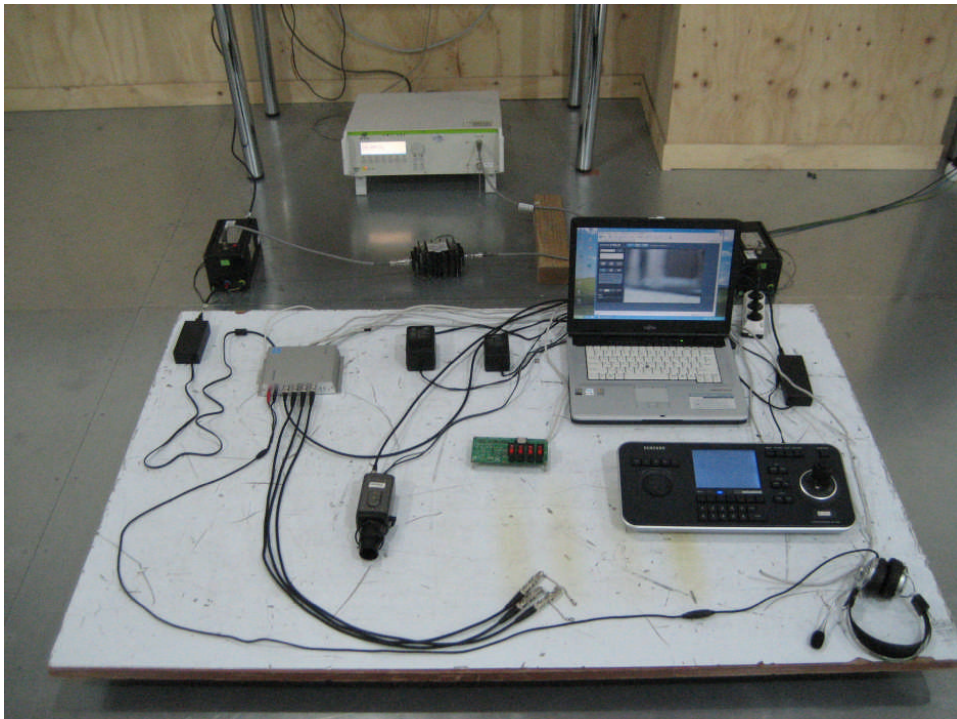

* Clamp

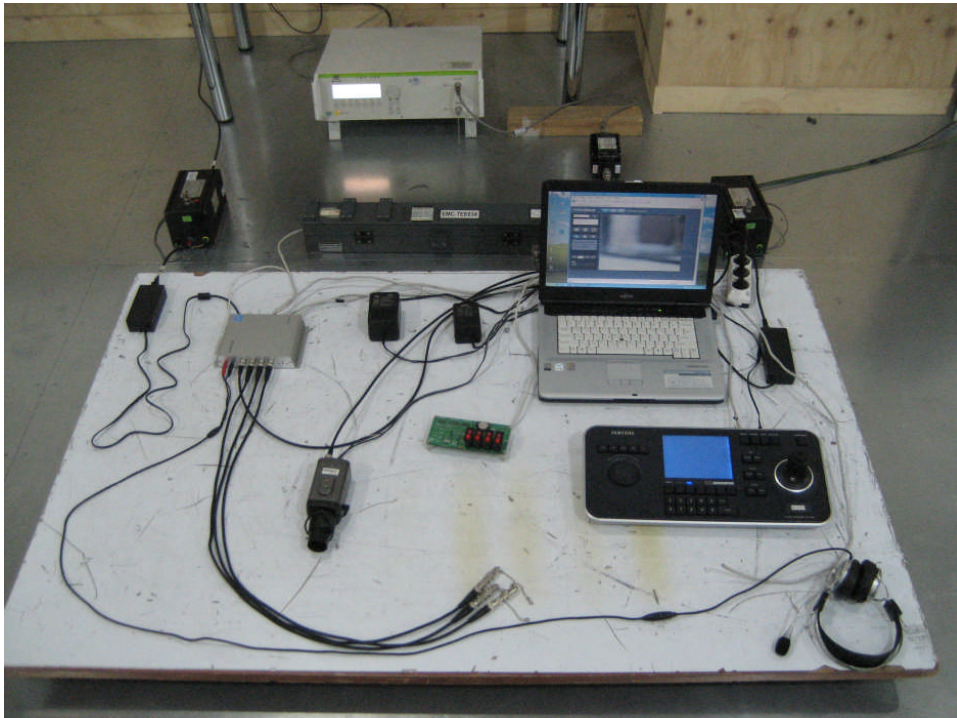

* CDN

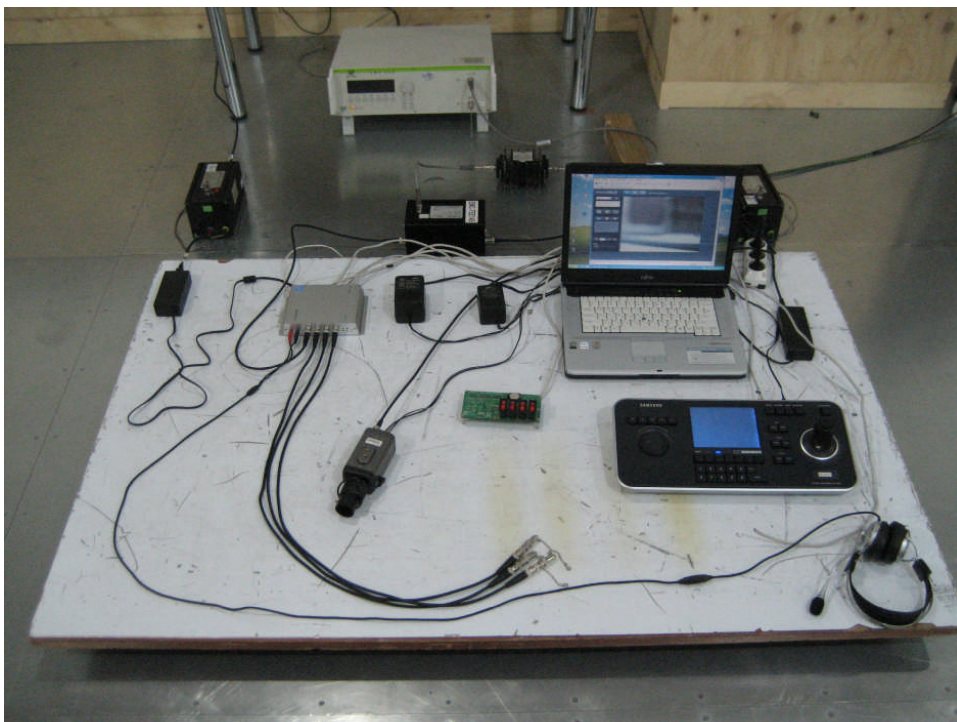

6.9.4 Measurement result

Coupling point	Coupling method	Result
Power	CDN (M3)	Complied

* Signal

Coupling point	Coupling method	Result
Video In (BNC)	CDN(S1/75)	Complied
RS-485	Clamp	Complied
Sensor	Clamp	Complied
Relay Out	Clamp	Complied

* Telecommunication

Coupling point	Coupling method	Result
Ethernet(RJ-45)	Clamp	Complied

6.10 Dips and Interruptions

Test specification	EN 61000-4-11:2004				
Number of dips	3 T				
Duration	10 s				
Phase	Zero crossing (0 °, 180 °)				
Testing Voltage	100 V, 50 Hz, 240 V, 50 Hz				
Date	2010. 11. 13				
Temperature (°C)	21 °C	Humidity (% R.H)	32 % R.H	Pressure (kPa)	101.0 kPa
Remarks	Complied - There was no change of operation status during above testing.				

6.10.1 Measurement procedure

The dips/interruption test is only applicable to AC mains.

The dips/interruptions were applied at zero crossing.

6.10.2 Used equipments

Equipment	Model no.	Serial no.	Makers	Next Cal. date	Used
Generator	UCS 500 M6	V0545100858	EM TEST	11.02.02	<input checked="" type="checkbox"/>

6.10.3 Photographs of test setup



6.10.4 Measurement result

* Tested voltage: 240 V, 50 Hz

Test Level (% UT)	Dip/Int. (% UT)	Duration /Period	Phase (°)	Count number	Result
0 %	100 %	0.5, 1, 5 Period	0 / 180	3T	Complied
40 %	60 %	0.5, 1, 5, 10 Period	0 / 180	3T	Complied
70 %	30 %	0.5, 1, 5, 10 Period	0 / 180	3T	Complied

Comment:

- There was no change of operation status during above testing.

* Tested voltage: 100 V, 50 Hz

Test Level (% UT)	Dip/Int. (% UT)	Duration /Period	Phase (°)	Count number	Result
0 %	100 %	0.5, 1, 5 Period	0 / 180	3T	Complied
40 %	60 %	0.5, 1, 5, 10 Period	0 / 180	3T	Complied
70 %	30 %	0.5, 1, 5, 10 Period	0 / 180	3T	Complied

Comment:

- There was no change of operation status during above testing.

6.11 Mains supply voltage variations

Test specification	EN 50130-4:2003				
Supply voltage	$U_{nom} + 10\%$, $U_{nom} - 15\%$				
Testing voltage	100 V, 50 Hz, 240 V, 50 Hz				
Date	2010. 11. 13				
Temperature (°C)	21 °C	Humidity (% R.H)	32 % R.H	Pressure (kPa)	101.0 kPa
Remarks	Complied - There was no change of operation status during above testing.				

6.11.1 Used equipments

Equipment	Model no.	Serial no.	Makers	Next Cal. Date	Used
Generator	UCS 500 M6	V0545100858	EM TEST	11.02.02	<input checked="" type="checkbox"/>

6.11.2 Measurement result

* Tested voltage: 240 V, 50 Hz

Supply voltage		Result
+ 10 %	264 V	Complied
- 15 %	204 V	Complied

* Tested voltage: 100 V, 50 Hz

Supply voltage		Result
+ 10 %	110 V	Complied
- 15 %	85 V	Complied

7. E.U.T. photographs

Front View



Rear View

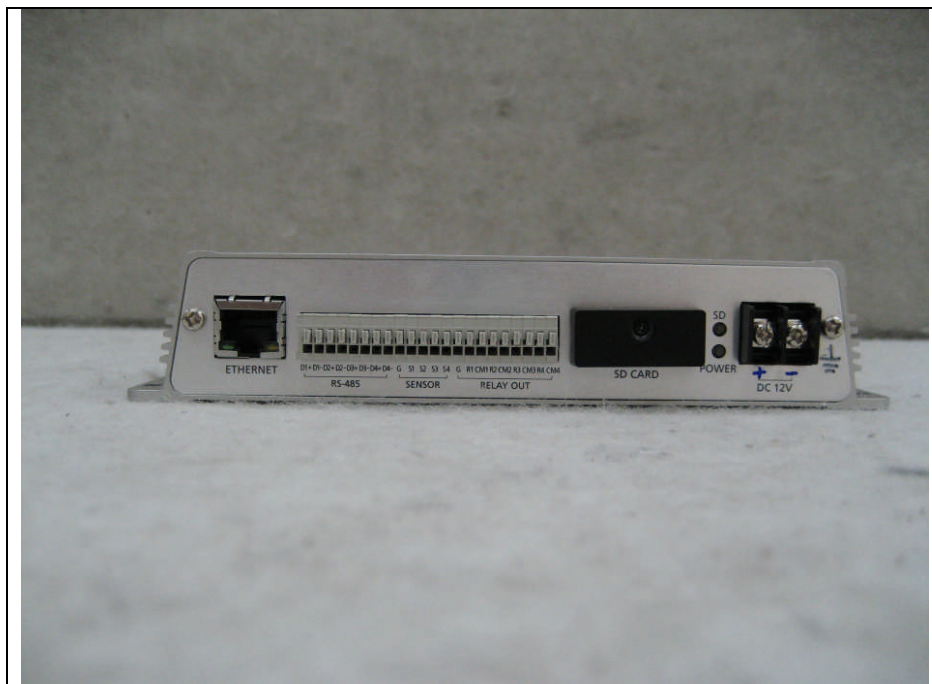

Left View

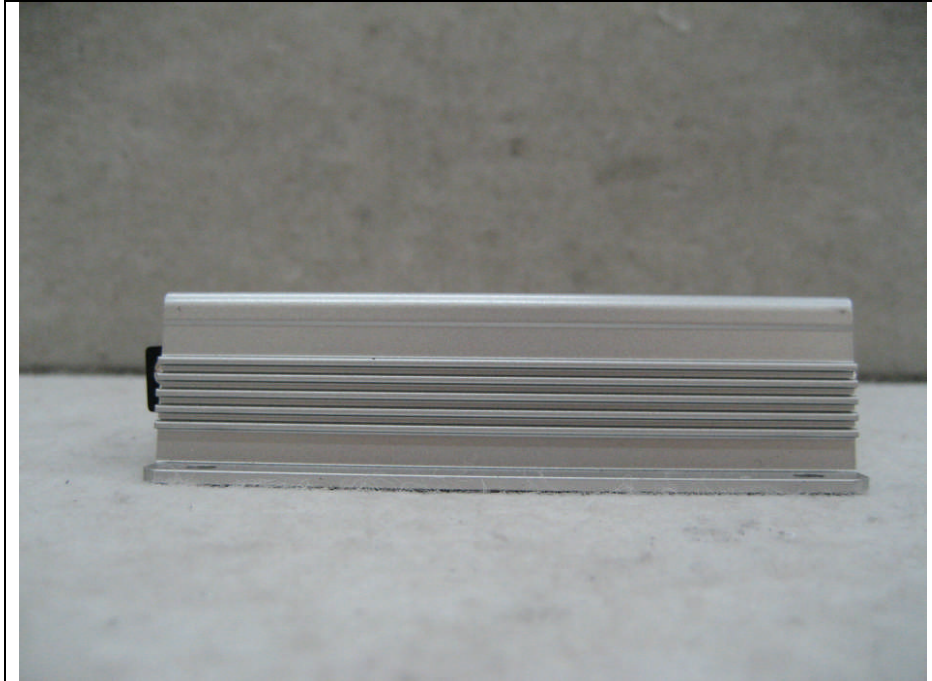

Right View

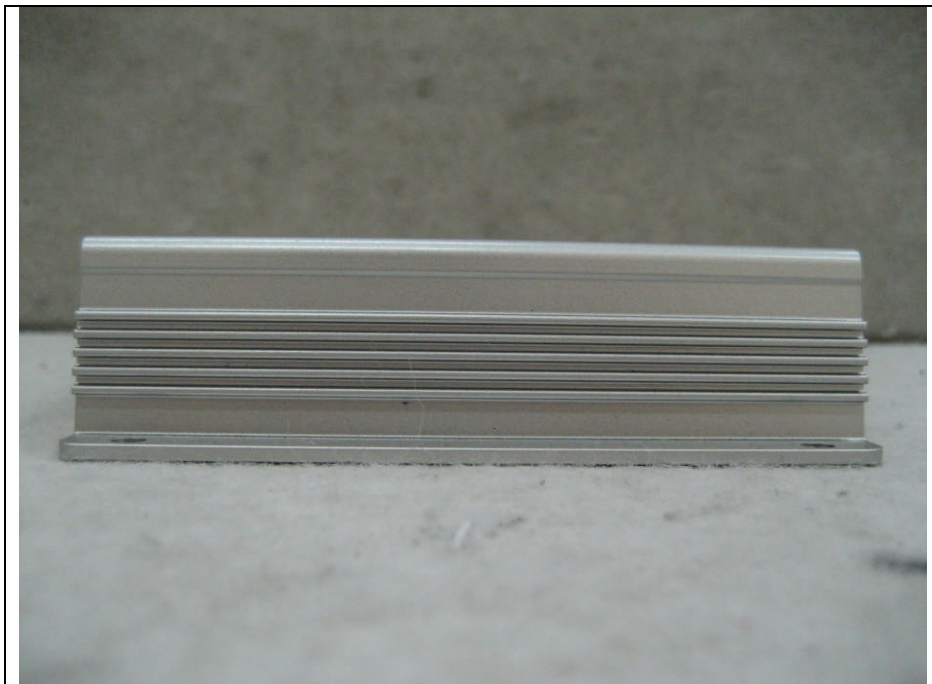

Top View



Bottom View



Inside

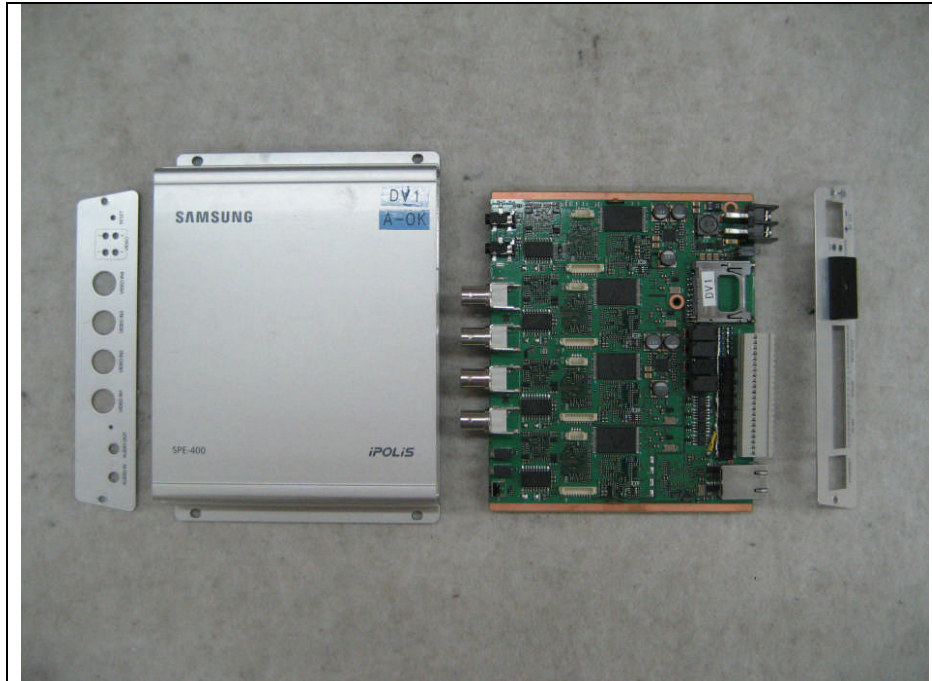

Main Board

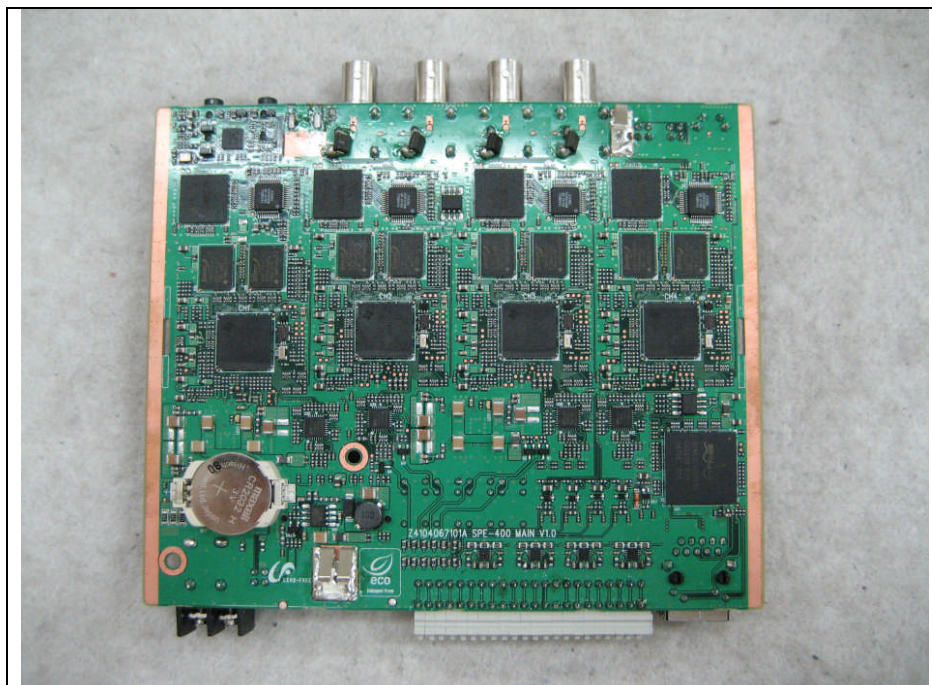
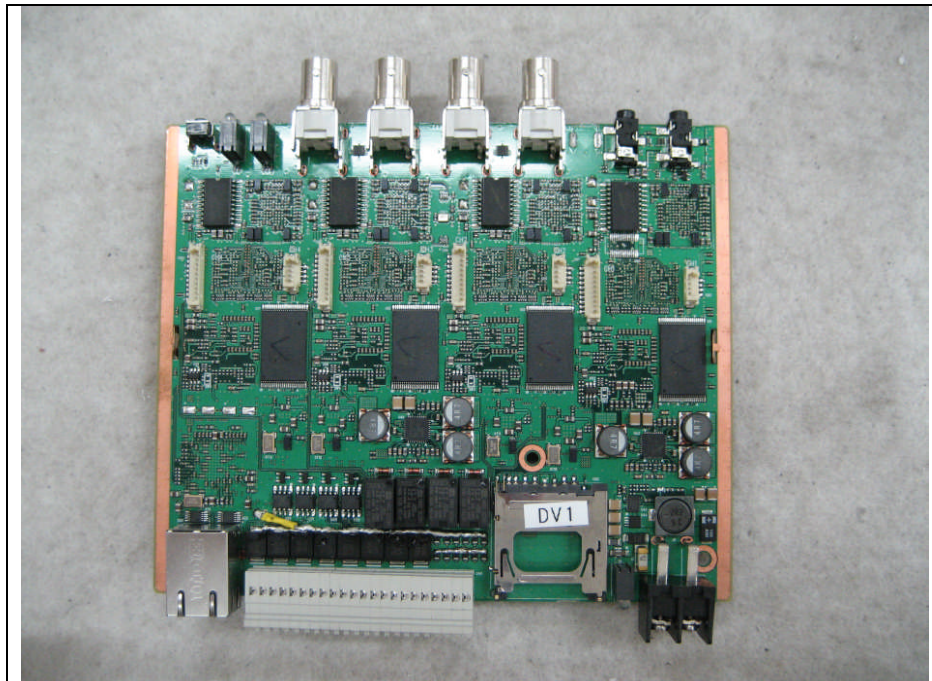

Adaptor

