



Network Video Recorder

User Manual

User Manual

COPYRIGHT ©2018 Hangzhou Hikvision Digital Technology Co., Ltd.

ALL RIGHTS RESERVED.

Any and all information, including, among others, wordings, pictures, graphs are the properties of Hangzhou Hikvision Digital Technology Co., Ltd. or its subsidiaries (hereinafter referred to be “Hikvision”). This user manual (hereinafter referred to be “the Manual”) cannot be reproduced, changed, translated, or distributed, partially or wholly, by any means, without the prior written permission of Hikvision. Unless otherwise stipulated, Hikvision does not make any warranties, guarantees or representations, express or implied, regarding to the Manual.

About this Manual

This Manual is applicable to Network Video Recorder (device).

The Manual includes instructions for using and managing the product. Pictures, charts, images and all other information hereinafter are for description and explanation only. The information contained in the Manual is subject to change, without notice, due to firmware updates or other reasons. Please find the latest version in the company website (<http://overseas.hikvision.com/en/>).

Please use this user manual under the guidance of professionals.

Trademarks Acknowledgement

HIKVISION and other Hikvision’s trademarks and logos are the properties of Hikvision in various jurisdictions. Other trademarks and logos mentioned below are the properties of their respective owners.

Legal Disclaimer

TO THE MAXIMUM EXTENT PERMITTED BY APPLICABLE LAW, THE PRODUCT DESCRIBED, WITH ITS HARDWARE, SOFTWARE AND FIRMWARE, IS PROVIDED “AS IS”, WITH ALL FAULTS AND ERRORS, AND HIKVISION MAKES NO WARRANTIES, EXPRESS OR IMPLIED, INCLUDING WITHOUT LIMITATION, MERCHANTABILITY, SATISFACTORY QUALITY, FITNESS FOR A PARTICULAR PURPOSE, AND NON-INFRINGEMENT OF THIRD PARTY. IN NO EVENT WILL HIKVISION, ITS DIRECTORS, OFFICERS, EMPLOYEES, OR AGENTS BE LIABLE TO YOU FOR ANY SPECIAL, CONSEQUENTIAL, INCIDENTAL, OR INDIRECT DAMAGES, INCLUDING, AMONG OTHERS, DAMAGES FOR LOSS OF BUSINESS PROFITS, BUSINESS INTERRUPTION, OR LOSS OF DATA OR DOCUMENTATION, IN CONNECTION WITH THE USE OF THIS PRODUCT, EVEN IF HIKVISION HAS BEEN ADVISED OF THE POSSIBILITY OF SUCH DAMAGES.

REGARDING TO THE PRODUCT WITH INTERNET ACCESS, THE USE OF PRODUCT SHALL BE WHOLLY AT YOUR OWN RISKS. HIKVISION SHALL NOT TAKE ANY RESPONSIBILITIES FOR ABNORMAL OPERATION, PRIVACY LEAKAGE OR OTHER DAMAGES RESULTING FROM CYBER ATTACK, HACKER ATTACK, VIRUS INSPECTION, OR OTHER INTERNET SECURITY RISKS; HOWEVER, HIKVISION WILL PROVIDE TIMELY TECHNICAL SUPPORT IF REQUIRED.

SURVEILLANCE LAWS VARY BY JURISDICTION. PLEASE CHECK ALL RELEVANT LAWS IN YOUR JURISDICTION BEFORE USING THIS PRODUCT IN ORDER TO ENSURE THAT YOUR USE CONFORMS THE APPLICABLE LAW. HIKVISION SHALL NOT BE LIABLE IN THE EVENT THAT THIS PRODUCT IS USED WITH ILLEGITIMATE PURPOSES.

IN THE EVENT OF ANY CONFLICTS BETWEEN THIS MANUAL AND THE APPLICABLE LAW, THE LATER PREVAILS.

Regulatory Information

FCC Information

Please take attention that changes or modification not expressly approved by the party responsible for compliance could void the user's authority to operate the equipment.

FCC compliance: This equipment has been tested and found to comply with the limits for a Class A digital device, pursuant to part 15 of the FCC Rules. These limits are designed to provide reasonable protection against harmful interference when the equipment is operated in a commercial environment. This equipment generates, uses, and can radiate radio frequency energy and, if not installed and used in accordance with the instruction manual, may cause harmful interference to radio communications. Operation of this equipment in a residential area is likely to cause harmful interference in which case the user will be required to correct the interference at his own expense.

FCC Conditions

This device complies with part 15 of the FCC Rules. Operation is subject to the following two conditions:

1. This device may not cause harmful interference.
2. This device must accept any interference received, including interference that may cause undesired operation.

EU Conformity Statement

 This product and - if applicable - the supplied accessories too are marked with "CE" and comply therefore with the applicable harmonized European standards listed under the EMC Directive 2014/30/EU, the LVD Directive 2014/35/EU, the RoHS Directive 2011/65/EU.

 2012/19/EU (WEEE directive): Products marked with this symbol cannot be disposed of as unsorted municipal waste in the European Union. For proper recycling, return this product to your local supplier upon the purchase of equivalent new equipment, or dispose of it at designated collection points. For more information see: www.recyclethis.info

 2006/66/EC (battery directive): This product contains a battery that cannot be disposed of as unsorted municipal waste in the European Union. See the product documentation for specific battery information. The battery is marked with this symbol, which may include lettering to indicate cadmium (Cd), lead (Pb), or mercury (Hg). For proper recycling, return the battery to your supplier or to a designated collection point. For more information see: www.recyclethis.info

Industry Canada ICES-003 Compliance

This device meets the CAN ICES-3 (A)/NMB-3(A) standards requirements.



Applicable Models

This manual is applicable to the models listed in the following table.

Series	Model
DS-9600NI-I8	DS-9608NI-I8
	DS-9616NI-I8
	DS-9632NI-I8
	DS-9664NI-I8
DS-9600NI-I16	DS-9616NI-I16
	DS-9632NI-I16
	DS-9664NI-I16
DS-7600NI-I2	DS-7608NI-I2
	DS-7616NI-I2
	DS-7632NI-I2
DS-7600NI-I2/P	DS-7608NI-I2/8P
	DS-7616NI-I2/16P
	DS-7632NI-I2/16P
DS-7700NI-I4	DS-7708NI-I4
	DS-7716NI-I4
	DS-7732NI-I4
DS-7700NI-I4/P	DS-7708NI-I4/8P
	DS-7716NI-I4/16P
	DS-7732NI-I4/16P

Symbol Conventions

The symbols that may be found in this document are defined as follows.

Symbol	Description
 NOTE	Provides additional information to emphasize or supplement important points of the main text.
 WARNING	Indicates a potentially hazardous situation, which if not avoided, could result in equipment damage, data loss, performance degradation, or unexpected results.
 DANGER	Indicates a hazard with a high level of risk, which if not avoided, will result in death or serious injury.

Safety Instructions

- Proper configuration of all passwords and other security settings is the responsibility of the installer and/or end-user.
- In the use of the product, you must be in strict compliance with the electrical safety regulations of the nation and region. Please refer to technical specifications for detailed information.
- Input voltage should meet both the SELV (Safety Extra Low Voltage) and the Limited Power Source with 100~240 VAC, 48 VDC or 12 VDC according to the IEC60950-1 standard. Please refer to technical specifications for detailed information.
- Do not connect several devices to one power adapter as adapter overload may cause over-heating or a fire hazard.
- Please make sure that the plug is firmly connected to the power socket.
- If smoke, odor or noise rise from the device, turn off the power at once and unplug the power cable, and then please contact the service center.

Preventive and Cautionary Tips

Before connecting and operating your device, please be advised of the following tips:

- Ensure unit is installed in a well-ventilated, dust-free environment.
- Unit is designed for indoor use only.
- Keep all liquids away from the device.
- Ensure environmental conditions meet factory specifications.
- Ensure unit is properly secured to a rack or shelf. Major shocks or jolts to the unit as a result of dropping it may cause damage to the sensitive electronics within the unit.
- Use the device in conjunction with an UPS if possible.
- Power down the unit before connecting and disconnecting accessories and peripherals.
- A factory recommended HDD should be used for this device.
- Improper use or replacement of the battery may result in hazard of explosion. Replace with the same or equivalent type only. Dispose of used batteries according to the instructions provided by the battery manufacturer.

Product Key Features

General

- Connectable to network cameras, network dome and encoders
- Connectable to the third-party network cameras like Acti, Arecont, Axis, Bosch, Brickcom, Canon, Panasonic, Pelco, Samsung, Sanyo, Sony, Vivotek and Zavio, and cameras that adopt ONVIF or PSIA protocol
- Connectable to smart IP cameras
- H.265+/H.265/ H.264+/H.264/MPEG4 video formats
- PAL/NTSC adaptive video inputs
- Each channel supports dual-stream
- Up to 8/16/32/64 network cameras can be added according to model
- Independent configuration for each channel, including resolution, frame rate, bit rate, image quality, etc.
- The quality of the input and output record is configurable

Local Monitoring

- HDMI/VGA1 and HDMI2/VGA2 outputs provided
- HDMI video output at up to 4K resolution
- Multi-screen display in live view is supported, and the display sequence of channels is adjustable
- Live view screen can be switched in groups. Manual switch and auto-switch are provided and the auto-switch interval is configurable
- Custom window-division live view layout configuration
- 3D positioning in live view
- Configurable main stream and sub-stream for the live view
- Quick setting menu is provided for live view
- POS information overlay on live view
- Motion detection, video tampering, video exception alert and video loss alert functions
- Privacy mask
- Multiple PTZ protocols supported; PTZ preset, patrol and pattern
- Zooming in by clicking the mouse and PTZ tracing by dragging mouse

HDD Management

- Up to 16 SATA hard disks and 1 eSATA disk can be connected for I16 models, and up to 8 SATA hard disks and 1 eSATA disk can be connected for I8 and K8 models
- Up to 8 TB storage capacity for each disk supported

- 8 network disks (NAS/IP SAN disk)
- S.M.A.R.T. and bad sector detection
- HDD group management
- Supports HDD standby function
- HDD property: redundancy, read-only, read/write (R/W)
- HDD quota management; different capacities can be assigned to different channels
- RAID 0, RAID 1, RAID 5, RAID 6 and RAID 10 are supported
- Hot-swappable RAID storage scheme can be enabled and disabled upon demand. 16 arrays can be configured
- Disk clone to the eSATA disk
- HDD health monitoring

Recording, Capture and Playback

- Holiday recording schedule configuration
- Continuous and event video recording parameters
- Multiple recording types: manual, continuous, alarm, motion, motion | alarm, motion & alarm VCA, and POS
- Eight recording time periods with separated recording types
- POS information overlay on image
- Pre-record and post-record for alarm, motion detection for recording, and pre-record time for schedule and manual recording
- Searching record files and captured pictures by events (alarm input/motion detection)
- Tag adding for record files, searching and playing back by tags
- Locking and unlocking record files
- Local redundant recording and capture
- Normal/Smart/custom video playback mode
- Playback by video synopsis
- Searching and playing back record files by channel number, recording type, start time, end time, etc.
- Supports playback by main stream or sub stream
- Smart search for the selected area in the video
- Zooming in when playback
- Reverse playback of multi-channel
- Supports pause, play reverse, speed up, speed down, skip forward, and skip backward when playback, and locating by dragging the mouse
- Supports thumbnails view and fast view during playback
- Up to 16-ch synchronous playback at 1080p real time

- Supports playback by transcoded stream
- Manual capture, continuous capture of video images and playback of captured pictures
- Supports enabling H.264+ to ensure high video quality with lowered bitrate

Files Management

- Search and export vehicle detection files and human appearance files
- Export video data by USB, SATA or eSATA device
- Export video clips when playback
- Either Normal or Hot Spare working mode is configurable to constitute an N+1 hot spare system

Alarm and Exception

- Configurable arming time of alarm input/output
- Alarm for video loss, motion detection, tampering, abnormal signal, video input/output standard mismatch, illegal login, network disconnected, IP confliction, abnormal record/capture, HDD error, and HDD full, etc.
- POS triggered alarm
- VCA detection alarm is supported
- Smart analysis for people counting and heat map
- Connectable to the thermal network camera
- Alarm triggers full screen monitoring, audio alarm, notifying surveillance center, sending e-mail and alarm output
- Automatic restore when system is abnormal

Other Local Functions

- Operable by front panel, mouse, remote control, or control keyboard
- Three-level user management; admin user is allowed to create many operating accounts and define their operating permission, which includes the limit to access any channel
- Admin password resetting by exporting/importing a GUID file
- Operation, alarm, exceptions, and log recording and searching
- Manually triggering and clearing alarms
- Import and export device configuration information

Network Function

- Two self-adaptive 10M/100M/1000 Mbps network interfaces
- IPv6 is supported
- TCP/IP protocol, DHCP, DNS, DDNS, NTP, SADP, SMTP, NFS, and iSCSI are supported
- TCP, UDP and RTP for unicast
- Auto/Manual port mapping by UPnP™

- Support access by Hik-Connect
- Remote Web browser access by HTTPS ensures high security
- ANR (Automatic Network Replenishment) function is supported, which enables the IP camera to save the recording files in the local storage when the network is disconnected, and synchronizes the files to the device when the network is resumed
- Remote reverse playback via RTSP
- Supports accessing the platform via ONVIF
- Remote search, playback, download, locking and unlocking of the record files, and supports downloading files upon broken transfer resume
- Remote parameters setup; remote import/export of device parameters
- Remote viewing of the device status, system logs and alarm status
- Remote keyboard operation
- Remote HDD formatting and program upgrading
- Remote system restart and shutdown
- RS-232, RS-485 transparent channel transmission
- Alarm and exception information can be sent to the remote host
- Remotely start/stop recording
- Remotely start/stop alarm output
- Remote PTZ control
- Remote JPEG capture
- Virtual host function to access and manage the IP camera directly
- Two-way audio and voice broadcasting
- Embedded Web server

Development Scalability

- SDK for Windows system
- Source code of application software for demo
- Development support and training for application system

TABLE OF CONTENTS

Introduction.....	18
1.1 Front Panel	18
1.1.1 DS-9600NI Series.....	18
1.1.2 DS-7700NI Series.....	22
1.1.3 DS-7600NI Series.....	24
1.2 IR Remote Control Operations.....	24
1.3 USB Mouse Operation.....	30
1.4 Rear Panel.....	31
1.4.1 DS-9600NI Series.....	31
1.4.2 DS-7600NI Series.....	32
1.4.3 DS-7700NI Series.....	34
Chapter 2 Getting Started.....	36
2.1 Start up the Device	36
2.2 Activate the Device	36
2.3 Configure Login Unlock Pattern.....	38
2.4 Login to the Device	39
2.4.1 Log in via Unlock Pattern	39
2.4.2 Log in via a Password.....	39
2.5 Start Setup Wizard.....	40
2.6 Enter Main Menu.....	44
2.7 System Operation	45
2.7.1 Log out.....	45
2.7.2 Shut Down the Device	45
2.7.3 Reboot the Device.....	45
Chapter 3 Camera Management.....	46
3.1 Add IP Cameras.....	46
3.1.1 Add IP Cameras Manually.....	46
3.1.2 Add the Automatically Searched Online IP Cameras	47
3.2 Manage Cameras for PoE Device.....	47
3.2.1 Add PoE Cameras	48
3.2.2 Add Non-PoE IP Cameras.....	48
3.2.3 Configure PoE Interface.....	49

3.3 Enable the H.265 Stream Access	50
3.4 Upgrade the IP Camera	50
3.5 Configure the Customized Protocols	51
Chapter 4 Camera Settings	53
4.1 Configure OSD Settings	53
4.2 Configure Privacy Mask.....	54
4.3 Configure the Image Parameters.....	55
4.4 Configure the Day/Night Switch	55
4.5 Configure Other Camera Parameters.....	55
Chapter 5 Live View	57
5.1 Start Live View	57
5.1.1 Digital Zoom	57
5.1.2 Fisheye View.....	57
5.1.3 3D Positioning	58
5.1.4 Live View Strategy.....	58
5.2 Target Detection	59
5.3 Configure Live View Settings.....	59
5.4 Configure Live View Layout	60
5.4.1 Configure Custom Live View Layout	60
5.4.2 Configure Live View Mode	61
5.5 Configure Camera Auto-Switch	62
5.6 Configure Channel-Zero Encoding	62
Chapter 6 PTZ Control	64
6.1 PTZ Control Wizard	64
6.2 ConfigurePTZ Parameters.....	64
6.3 Set PTZ Presets, Patrols, and Patterns	65
6.3.1 Set Presets	65
6.3.2 Call Presets.....	66
6.3.3 Set Patrols.....	67
6.3.4 Call a Patrol	68
6.3.5 Set a Pattern	69
6.3.6 Call a Pattern.....	69
6.3.7 Set Linear Scan Limits	70
6.3.8 Call Linear Scan	71
6.3.9 One-Touch Park.....	71

6.4 Auxiliary Functions.....	72
Chapter 7 Storage.....	73
7.1 Storage Device Management	73
7.1.1 Install the HDD	73
7.1.2 Add the Network Disks.....	73
7.1.3 Configure eSATA for Data Storage.....	75
7.2 Storage Mode	76
7.2.1 Configure HDD Groups	76
7.2.2 Configure HDD Quota.....	78
7.3 Recording Parameters.....	79
7.3.1 Main Stream	79
7.3.2 Sub-Stream	79
7.3.3 Picture	80
7.3.4 ANR.....	80
7.3.5 Configure Advanced Recording Settings	80
7.4 Configure Recording Schedule.....	81
7.5 Configure Continuous Recording.....	83
7.6 Configure Motion Detection Triggered Recording.....	83
7.7 Configure Event Triggered Recording.....	84
7.8 Configure Alarm Triggered Recording.....	84
7.9 Configure POS Event Triggered Recording	85
7.10 Configure Picture Capture	85
7.11 Configure Holiday Recording and Capture	85
7.12 Configure Redundant Recording and Capture.....	87
Chapter 8 Disk Array (RAID)	89
8.1 Create a Disk Array.....	89
8.1.1 Enable a RAID.....	89
8.1.2 One-Touch Creation	90
8.1.3 Manual Creation	90
8.2 Rebuild an Array	92
8.2.1 Configure a Hot Spare Disk.....	92
8.2.2 Automatically Rebuild an Array	92
8.2.3 Manually Rebuild an Array	93
8.3 Delete an Array	94
8.4 Check and Edit Firmware	95

Chapter 9 File Management	96
9.1 Search and Export All Files	96
9.1.1 Search Files	96
9.1.2 Export Files	96
9.2 Search and Export Human Files	97
9.2.1 Search Human Files	97
9.2.2 Export Human Files	97
9.3 Search and Export Vehicle Files	98
9.3.1 Search Vehicle Files	98
9.3.2 Export Vehicle Files	98
9.4 Search History Operation	99
9.4.1 Save Search Conditions	99
9.4.2 Call Search History	99
Chapter 10 Playback	100
10.1 Play Video Files	100
10.1.1 Instant Playback	100
10.1.2 Play Normal Video	100
10.1.3 Play Smart Searched Video	101
10.1.4 Play Custom Searched Files	102
10.1.5 Play Tag Files	103
10.1.6 Play Event Files	105
10.1.7 Play Video Synopsis	107
10.1.8 Play by Sub-periods	107
10.1.9 Play Log Files	108
10.1.10 Play External Files	109
10.2 Playback Operations	109
10.2.1 Set Play Strategy in Smart/Custom Mode	109
10.2.2 Edit Video Clips	110
10.2.3 Switch between Main Stream and Sub-Stream	110
10.2.4 Thumbnails View	111
10.2.5 Fisheye View	111
10.2.6 Fast View	112
10.2.7 Digital Zoom	112
10.2.8 POS Information Overlay	112
Chapter 11 Event and Alarm Settings	113

11.1 Configure Arming Schedule	113
11.2 Configure Alarm Linkage Actions	113
11.3 Configure Motion Detection Alarms	115
11.4 Configure Video Loss Alarms	117
11.5 Configure Video Tampering Alarms	118
11.6 Configure Sensor Alarms	119
11.6.1 Configure Alarm Inputs	119
11.6.2 Configure One-Key Disarming	119
11.6.3 Configure Alarm Outputs	120
11.7 Configure Exceptions Alarms	122
11.8 Setting Alarm Linkage Actions	124
11.8.1 Configure Auto-Switch Full Screen Monitoring	124
11.8.2 Configure Audio Warning	124
11.8.3 Notify Surveillance Center	125
11.8.4 Configure E-mail Linkage	125
11.8.5 Trigger Alarm Outputs	125
11.8.6 Configure PTZ Linkage	125
11.9 Trigger or Clear Alarm Output Manually	126
Chapter 12 VCA Event Alarm	128
12.1 Face Detection	128
12.2 Vehicle Detection	129
12.3 Line Crossing Detection	130
12.4 Intrusion Detection	131
12.5 Region Entrance Detection	133
12.6 Region Exiting Detection	134
12.7 Unattended Baggage Detection	135
12.8 Object Removal Detection	136
12.9 Audio Exception Detection	137
12.10 Sudden Scene Change Detection	138
12.11 Defocus Detection	139
12.12 PIR Alarm	140
12.13 Thermal Camera Detection	142
Chapter 13 Smart Analysis	143
13.1 People Counting	143
13.2 Heat Map	143

Chapter 14 POS Configuration	145
14.1 Configure POS Settings.....	145
14.1.1 Configure POS Connection	145
14.1.2 Configure POS Text Overlay	149
14.2 Configure POS Alarm.....	150
Chapter 15 Network Settings	151
15.1 Configure TCP/IP Settings.....	151
15.1.1 Device with Dual Network Interface	151
15.1.2 Device with a Single Network Interface	152
15.2 Configure Hik-Connect	153
15.3 Configure DDNS	155
15.4 Configure PPPoE	156
15.5 Configure NTP	156
15.6 Configure SNMP.....	157
15.7 Configure Email.....	158
15.8 Configure Ports	159
Chapter 16 Hot Spare Device Backup	161
16.2 Set Hot Spare Device.....	161
16.3 Set Working Device	162
16.4 Manage Hot Spare System	162
Chapter 17 User Management and Security	164
17.1 Manage User Accounts.....	164
17.1.1 Add a User.....	164
17.1.2 Edit the Admin User	166
17.1.3 Edit an Operator/Guest User	167
17.1.4 Delete a User.....	168
17.2 Manage User Permissions	168
17.2.1 Set User Permissions	168
17.2.2 Set Local Live View Permission for Non-Admin Users.....	170
17.2.3 Set Live View Permission on Lock Screen.....	171
17.3 Configure Password Security	172
17.3.1 Export GUID File.....	172
17.3.2 Configure Security Questions	173
17.4 Reset Password	174
17.4.1 Reset Password by GUID.....	174

17.4.2 Reset Password by Security Questions.....	175
Chapter 18 System Service Maintenance	176
18.1 Storage Device Maintenance.....	176
18.1.1 Configure Disk Clone	176
18.1.2 S.M.A.R.T. Detection	177
18.1.3 Bad Sector Detection.....	178
18.1.4 HDD Health Detection	179
18.2 Search and Export Log Files.....	180
18.2.1 Search the Log Files.....	180
18.2.2 Export the Log Files	181
18.3 Import/Export IP Camera Configuration Files	182
18.4 Import/Export Device Configuration Files	184
18.5 Configure System Services	184
18.5.1 Control4 Protocol	184
18.5.2 I-VIEW-NOW UPNP Reporting	185
18.6 Configure Stream Encryption	185
18.7 Upgrade the System	186
18.7.1 Upgrade with a Local Backup Device.....	186
18.7.2 Upgrade by FTP	186
18.8 Restore Default Settings.....	188
Chapter 19 General System Settings.....	189
19.1 Configure General Settings.....	189
19.2 Configure Date & Time	190
19.3 Configure DST Settings.....	191
Chapter 20 Appendix.....	192
20.1 Glossary	192
20.2 Troubleshooting.....	194
20.3 Summary of Changes	202
Version 4.1.50.....	202
Version 4.1.10.....	202
Version 4.1.0.....	202
Version 3.4.92	202
Version 3.4.91.....	202
Version 3.4.90.....	202
Version 3.4.80.....	203

Version 3.4.70.....	203
Version 3.4.6.....	203
Version 3.4.2.....	203
Version 3.3.9.....	204
Version 3.3.7.....	204
Version 3.3.6.....	204
Version 3.3.4.....	204
20.4 List of IP Cameras Connected to PoE by Long Network Cable (100 - 300 m).....	205

Introduction

1.1 Front Panel

1.1.1 DS-9600NI Series

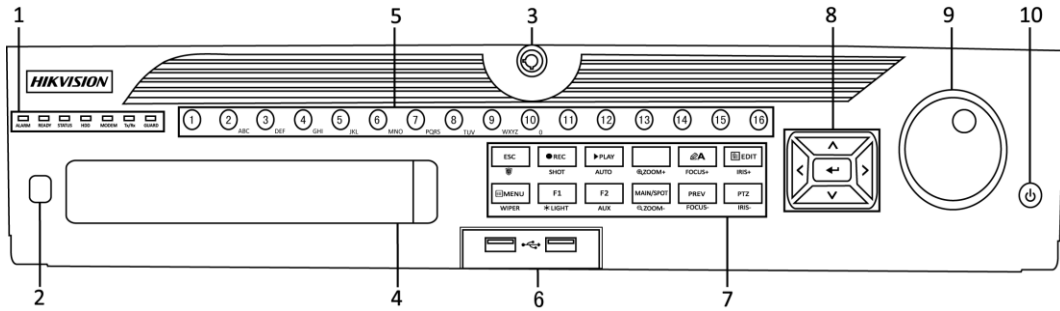

Figure 1-1 DS-9600NI-I8 Series

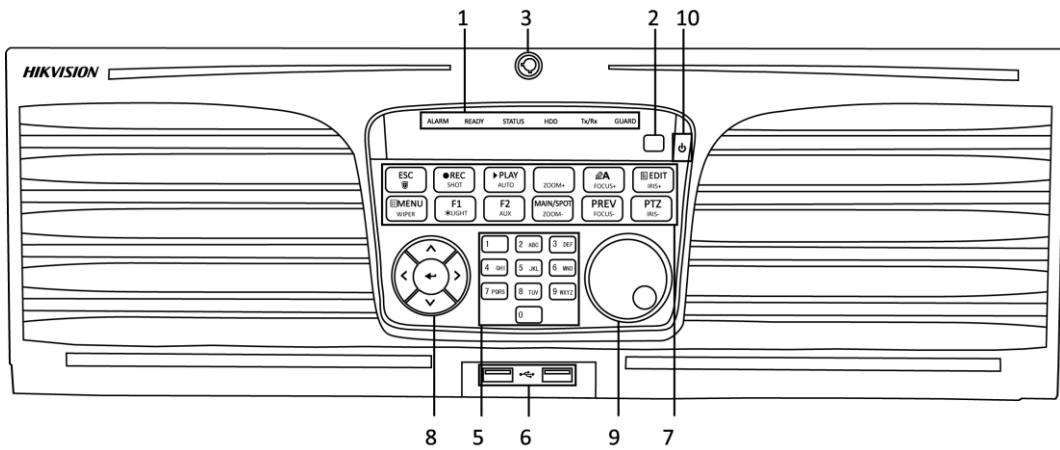

Figure 1-2 DS-9600NI-I16 Series

Table 1-1 Panel Description

No.	Name	Function Description	
1	Status Indicators	ALARM	Turns red when a sensor alarm is detected.
		READY	Turns blue when the device is functioning properly.
		STATUS	Turns blue when device is controlled by an IR remote.
			Turns red when controlled by a keyboard and purple when IR remote and keyboard is used at the same time.
		HDD	Flickers red when data is being read from or written to HDD.
		MODEM	Reserved for future usage.
		Tx/Rx	Flickers blue when network connection is functioning properly.
		GUARD	Turns blue when the device is in armed status; at this time, an alarm is enabled when an event is detected.
Turns off when the device is unarmed. The arm/disarm status can be changed by pressing and holding on the ESC button for more than 3 seconds in live view mode.			
2	IR Receiver	Receiver for IR remote control.	
3	Front Panel Lock	Locks or unlocks the panel by the key.	
4	DVD-R/W	Slot for DVD-R/W disk.	
5	Alphanumeric Buttons	Switches to the corresponding channel in live view or PTZ control mode.	
		Inputs numbers and characters in edit mode.	
		Switches between different channels in playback mode.	
		Turns blue when the corresponding channel is recording; turns red when the channel is in network transmission status; turns pink when the channel is recording and transmitting.	

No.	Name	Function Description	
6	USB Interfaces	Universal Serial Bus (USB) ports for additional devices such as USB mouse and USB Hard Disk Drive (HDD).	
7	Composite Keys	ESC	Returns to the previous menu.
		ESC	Presses for arming/disarming the device in live view mode.
		REC/SHOT	Enters the Manual Record settings menu.
			Presses this button followed by a numeric button to call a PTZ preset in PTZ control settings.
			Turns audio on/off in the playback mode.
		PLAY/AUTO	Enters the playback mode.
			Automatically scans in the PTZ control menu.
		ZOOM+	Zooms in the PTZ camera in the PTZ control setting.
		A/FOCUS+	Adjusts focus in the PTZ Control menu.
			Switches between input methods (upper and lower case alphabet, symbols and numeric input).
		EDIT/IRIS+	Edits text fields. When editing text fields, it also deletes the character in front of the cursor.
			Checks the checkbox in the checkbox fields.
			Adjusts the iris of the camera in PTZ control mode.
			Generates video clips for backup in playback mode.
			Enters/exits the folder of USB device and eSATA HDD.
MAIN/SPOT/ZOOM-	Switches between main and spot output.		
	Zooms out the image in PTZ control mode.		
F1/ LIGHT	Selects all items on the list when used in a list field.		

No.	Name	Function Description			
		Turns on/off PTZ light (if applicable) in PTZ control mode.			
		Switches between play and reverse play in playback mode.			
		F2/ AUX	Cycles through tab pages.		
			Switches between channels in synchronous playback mode.		
		MENU/WIPER	Returns to the Main menu (after successful login).		
			Presses and holds the button for five seconds to turn off audible key beep.		
			Starts wiper (if applicable) in PTZ control mode.		
			Shows/hides the control interface in playback mode.		
		PREV/FOCUS-	Switches between single screen and multi-screen mode.		
			Adjusts the focus in conjunction with the A/FOCUS+ button in PTZ control mode.		
		PTZ/IRIS-	Enters the PTZ Control mode.		
			Adjusts the iris of the PTZ camera in PTZ control mode.		
		8	Control Buttons	DIRECTION	Navigates between different fields and items in menus.
					In the playback mode, use the Up and Down buttons to speed up and slow down recorded video. Use the Left and Right buttons to select the next and previous video files.
Cycles through channels in live view mode.					
Controls the movement of the PTZ camera in PTZ control mode.					
ENTER	Confirms selection in any of the menu modes.				
	Checks the checkbox fields.				

No.	Name	Function Description
		Plays or pauses the video playing in playback mode.
		Advances the video by a single frame in single-frame playback mode.
		Stops/starts auto switch in auto-switch mode.
9	JOG SHUTTLE Control	Moves the active selection up and down in a menu.
		Cycles through different channels in live view mode.
		Jumps 30s forward/backward in video files in the playback mode.
		Controls the movement of the PTZ camera in PTZ control mode.
10	POWER ON/OFF	Long press the button for more than 3 seconds to turn on/off the device.

1.1.2 DS-7700NI Series

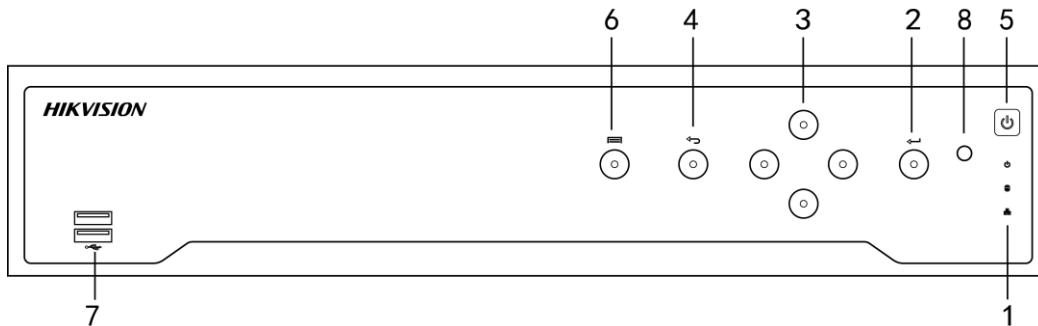

Figure 1-3 DS-7700NI Series

Table 1-2 Panel Description

No.	Name	Function Description	
1	Status Indicators	POWER	Turns green when device is powered up.
		HDD	Blinks red when HDD is reading/writing.
		Tx/Rx	Blinks green when network connection is functioning normally.
2	ENTER	The Enter button is used to confirm selection in menu mode; or used to check checkbox fields and ON/OFF switch.	
		In playback mode, it can be used to play or pause the video.	
		In single-frame play mode, pressing the Enter button will play the video by a single frame.	
		In auto sequence view mode, the buttons can be used to pause or resume auto sequence.	
		The Enter button is used to confirm selection in menu mode; or used to check checkbox fields and ON/OFF switch.	
3	DIRECTION	In menu mode, the direction buttons are used to navigate between different fields and items and select setting parameters.	
		In playback mode, the Up and Down buttons are used to speed up and slow down record playing, and the Left and Right buttons are used to move the recording 30s forwards or backwards.	
		In the image setting interface, the up and down button can adjust the level bar of the image parameters.	
		In live view mode, these buttons can be used to switch channels.	
4	Back	Back to the previous menu.	
5	POWER ON/OFF	Power on/off switch.	
6	MENU	Access the main menu interface.	
7	USB Interface	Universal Serial Bus (USB) ports for additional devices such as USB mouse and USB Hard Disk Drive (HDD).	

1.1.3 DS-7600NI Series

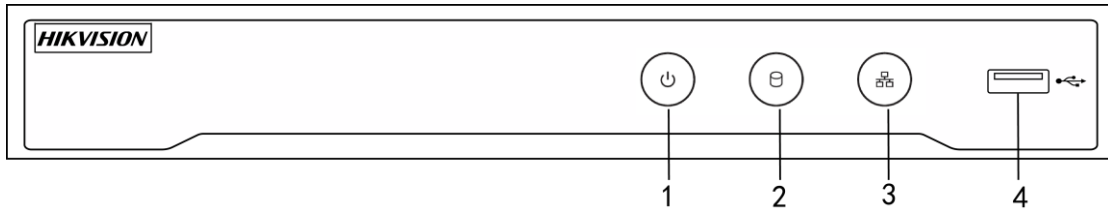

Figure 1-4 DS-7600NI Series

Table 1-3 Panel Description

No.	Name	Connections
1	POWER	Turns green when device is powered up.
2	HDD	Flickers red when data is being read from or written to HDD.
3	Tx/Rx	Flickers blue when network connection is functioning properly.
4	USB Interface	Universal Serial Bus (USB) port for additional devices such as USB mouse and USB Hard Disk Drive (HDD).

1.2 IR Remote Control Operations

The device may also be controlled with the included IR remote control, shown in Figure 1-5.



Batteries (2×AAA) must be installed before operation.

The IR remote is set at the factory to control the device (using default Device ID# 255) without any additional steps. Device ID# 255 is the default universal device identification number shared by the devices. You may also pair an IR Remote to a specific device by changing the Device ID#, as follows:

Pairing (Enabling) the IR Remote to a Specific Device (optional)

You can pair an IR Remote to a specific device by creating a user-defined Device ID#. This feature is useful when using multiple IR Remotes and devices.

On the device:

Step 1 Go to **System > General**.

Step 2 Type a number (255 digits maximum) into the Device No. field.

On the IR Remote:

Step 3 Press the DEV button.

Step 4 Use the Number buttons to enter the Device ID# that was entered into the device.

Step 5 Press Enter button to accept the new Device ID#.

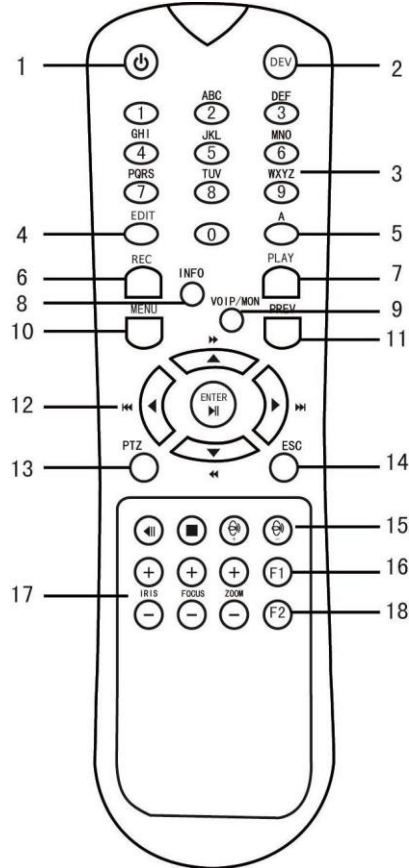

Figure 1-5 Remote Control

Unpairing (Disabling) an IR Remote from a Device

To unpair an IR Remote from a device so that the unit cannot control any device functions, proceed as follows:

Press the DEV key on the IR Remote. Any existing Device ID# will be erased from the unit’s memory and it will no longer function with the device.

 **NOTE**

(Re)-enabling the IR Remote requires pairing to a device. See “Pairing the IR Remote to a Specific device (optional),” above.

The keys on the remote control closely resemble the ones on the front panel. See the table 1.4.

Table 1-4 IR Remote Functions

No.	Name	Function Description
1	POWER ON/OFF	<ul style="list-style-type: none"> •To Turn Power On: <ul style="list-style-type: none"> -If User Has Not Changed the Default device Device ID# (255): <ol style="list-style-type: none"> 1.Press Power On/Off button (1). -If User Has Changed the device Device ID#: <ol style="list-style-type: none"> 1.Press DEV button. 2.Press Number buttons to enter user-defined Device ID#. 3.Press Enter button. 4.Press Power button to start device. •To Turn device Off: <ul style="list-style-type: none"> -If User Is Logged On: <ol style="list-style-type: none"> 1.Hold Power On/Off button (1) down for five seconds to display the “Yes/No” verification prompt. 2.Use Up/Down Arrow buttons (12) to highlight desired selection. 3.Press Enter button (12) to accept selection. -If User Is <i>Not</i> Logged On: <ol style="list-style-type: none"> 1.Hold Power On/Off button (1) down for five seconds to display the user name/password prompt. 2.Press the Enter button (12) to display the on-screen keyboard. 3.Input the user name. 4.Press the Enter button (12) to accept input and dismiss the on-screen keyboard. 5.Use the Down Arrow button (12) to move to the “Password” field. 6.Input password (use on-screen keyboard or numeric buttons (3) for numbers). 7.Press the Enter button (12) to accept input and dismiss the on-screen keyboard. 8.Press the OK button on the screen to accept input and display the Yes/No” verification prompt (use Up/Down Arrow buttons (12) to move between fields) 9.Press Enter button (12) to accept selection. <p>User name/password prompt depends on device is configuration.</p>

		See "System Configuration" section.
2	DEV	Enable IR Remote: Press DEV button, enter device Device ID# with number keys, press Enter to pair unit with the device
		Disable IR Remote: Press DEV button to clear Device ID#; unit will no longer be paired with the device
3	Numerals	Switch to the corresponding channel in Live View or PTZ Control mode
		Input numbers in Edit mode
4	EDIT	Delete characters before cursor
		Check the checkbox and select the ON/OFF switch
5	A	Adjust focus in the PTZ Control menu
		Switch on-screen keyboards (upper and lower case alphabet, symbols, and numerals)
6	REC	Enter Manual Record setting menu
		Call a PTZ preset by using the numeric buttons in PTZ control settings
		Turn audio on/off in Playback mode
7	PLAY	Go to Playback mode
		Auto scan in the PTZ Control menu
8	INFO	Reserved
9	VOIP	Switches between main and spot output
		Zooms out the image in PTZ control mode
10	MENU	Return to Main menu (after successful login)
		N/A
		Show/hide full screen in Playback mode
12	DIRECTION	Navigate between fields and menu items
		Use Up/Down buttons to speed up/slow down recorded video, and Left/Right buttons to advance/rewind 30 secs in Playback mode
		Cycle through channels in Live View mode
		Control PTZ camera movement in PTZ control mode

		Confirm selection in any menu mode
	ENTER	Checks checkbox
		Play or pause video in Playback mode
		Advance video a single frame in single-frame Playback mode
		Stop/start auto switch in auto-switch mode
13	PTZ	Enter PTZ Control mode
14	ESC	Go back to previous screen
		N/A
15	RESERVED	Reserved
16	F1	Select all items on a list
		N/A
		Switch between play and reverse play in Playback mode
17	PTZ Control	Adjust PTZ camera iris, focus, and zoom
18	F2	Cycle through tab pages
		Switch between channels in Synchronous Playback mode

Troubleshooting Remote Control:



Make sure you have installed batteries properly in the remote control. And you have to aim the remote control at the IR receiver in the front panel.

If there is no response after you press any button on the remote, follow the procedure below to troubleshoot.

Step 1 Go to **System > General** by operating the front control panel or the mouse.

Step 2 Check and remember device ID#. The default ID# is 255. This ID# is valid for all the IR remote controls.

Step 3 Press the DEV button on the remote control.

Step 4 Enter the device ID# you set in step 2.

Step 5 Press the ENTER button on the remote.

If the Status indicator on the front panel turns blue, the remote control is operating properly. If the Status indicator does not turn blue and there is still no response from the remote, please check the following:

- Batteries are installed correctly and the polarities of the batteries are not reversed.
- Batteries are fresh and not out of charge.
- IR receiver is not obstructed.
- No fluorescent lamp is used nearby

If the remote still can't function properly, please change a remote and try again, or contact the device provider.

1.3 USB Mouse Operation

A regular 3-button (Left/Right/Scroll-wheel) USB mouse can also be used with this device. To use a USB mouse:

Step 1 Plug USB mouse into one of the USB interfaces on the front panel of the device.

Step 2 The mouse should automatically be detected. If in a rare case that the mouse is not detected, the possible reason may be that the two devices are not compatible, please refer to the recommended the device list from your provider.

The operation of the mouse:

Table 1-5 Description of the Mouse Control

Name	Action	Description
Left-Click	Single-Click	Live view: Select channel and show the quick set menu. Menu: Select and enter.
	Double-Click	Live view: Switch between single-screen and multi-screen.
	Click and Drag	PTZ control: pan, tilt and zoom. Video tampering, privacy mask and motion detection: Select target area. Digital zoom-in: Drag and select target area. Live view: Drag channel/time bar.
Right-Click	Single-Click	Live view: Show menu. Menu: Exit current menu to upper level menu.
Scroll-Wheel	Scrolling up	Live view: Previous screen. Menu: Previous item.
	Scrolling down	Live view: Next screen. Menu: Next item.

1.4 Rear Panel

1.4.1 DS-9600NI Series

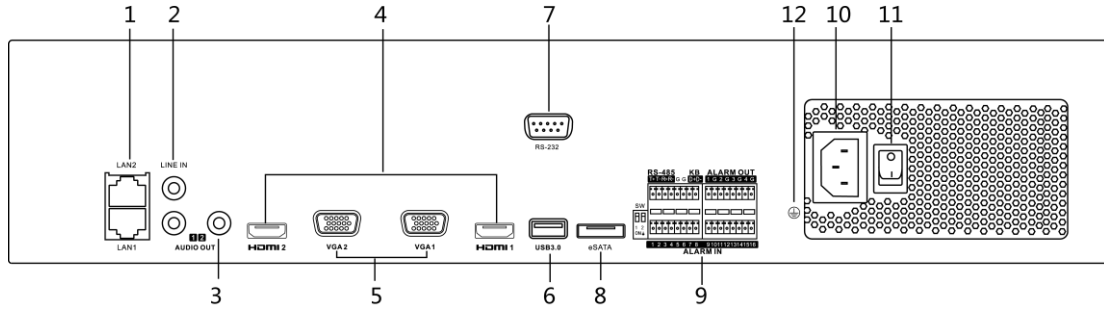

Figure 1-6 DS-9600NI-I8 Series

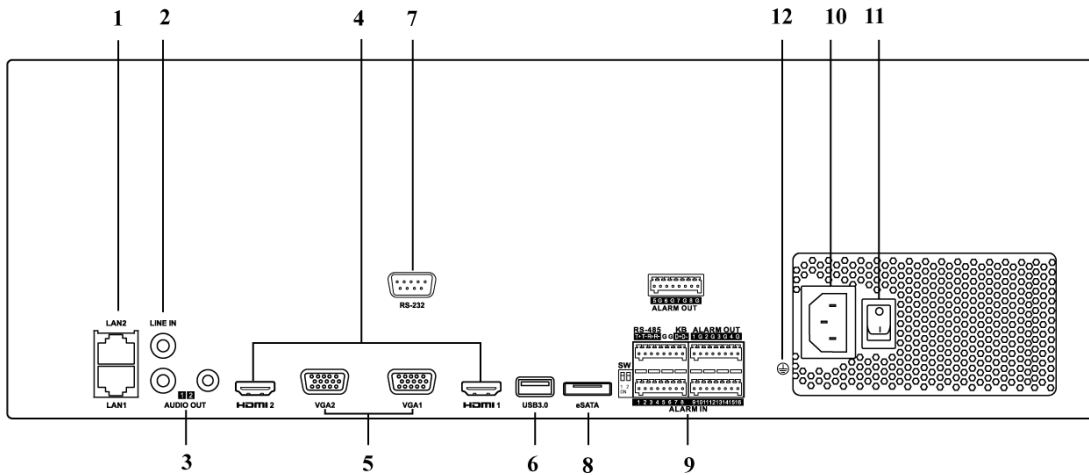

Figure 1-7 DS-9600NI-I16 Series

Table 1-6 Panel Description

No.	Name	Description
1	LAN1/LAN2 Interface	2 RJ-45 10/100/1000 Mbps self-adaptive Ethernet interfaces provided.
2	LINE IN	RCA connector for audio input.
3	AUDIO OUT	2 RCA connectors for audio output.
4	HDMI1/HDMI2	HDMI video output connector.
5	VGA1/VGA2	DB9 connector for VGA output. Display local video output and menu.
6	USB 3.0 interface	Universal Serial Bus (USB) ports for additional devices such as USB mouse and USB Hard Disk Drive (HDD).
7	RS-232 Interface	Connector for RS-232 devices.
8	eSATA	Connects external SATA HDD, CD/DVD-RM.
9	Controller Port	D+, D- pin connects to Ta, Tb pin of controller. For cascading devices, the first device's D+, D- pin should be connected with the D+, D- pin of the next device.
	ALARM IN	Connector for alarm input.
	ALARM OUT	Connector for alarm output.
10	100 to 240 VAC	100 to 240 VAC power supply.
11	Power Switch	Switch for turning on/off the device.
12	GROUND	Ground (needs to be connected when device starts up).

1.4.2 DS-7600NI Series

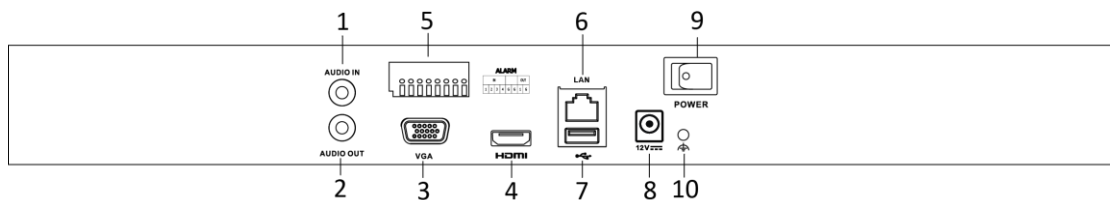

Figure 1-8 DS-7600NI-I2 Series

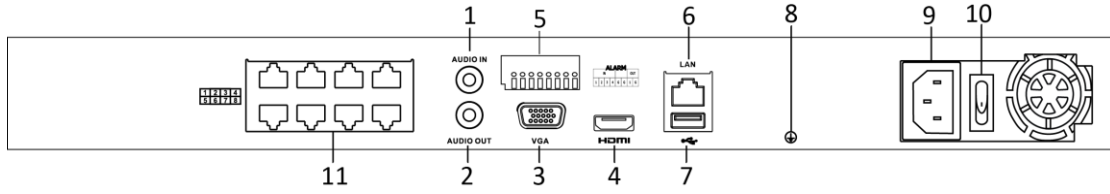

Figure 1-9 DS-7600NI-I2/8P Series

NOTE

The DS-7616NI-I2/16P and DS-7632NI-I2/16P provide 16 network Interfaces with PoE function.

Table 1-7 Panel Description

No.	Name	Description
1	Audio In	RCA connector for audio input.
2	Audio Out	RCA connector for audio output.
3	VGA Interface	DB9 connector for VGA output. Display local video output and menu.
4	HDMI Interface	HDMI video output connector.
5	ALARM IN	Connector for alarm input.
	ALARM OUT	Connector for alarm output.
6	LAN Network Interface	1 10/100/1000 Mbps self-adaptive Ethernet interface.
7	USB Interface	Universal Serial Bus (USB 3.0) ports for additional devices such as USB mouse and USB Hard Disk Drive (HDD).
8	Ground	Ground (needs to be connected when device starts up).
9	Power Supply	12 VDC power supply for DS-7600NI-I4, and 100 to 240 VAC for DS-7600NI-I4/P.
10	Power Switch	Switch for turning on/off the device.
11	Network Interfaces with PoE function (for DS-7600NI-I2/P)	Network interfaces for the cameras and to provide power over Ethernet.

1.4.3 DS-7700NI Series

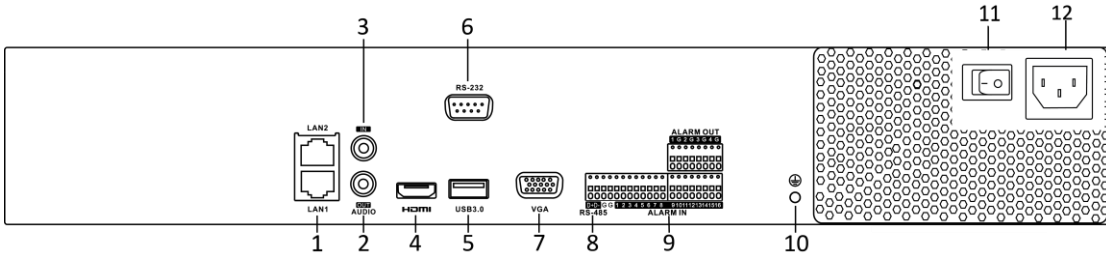

Figure 1-10 DS-7700NI-I4 Series

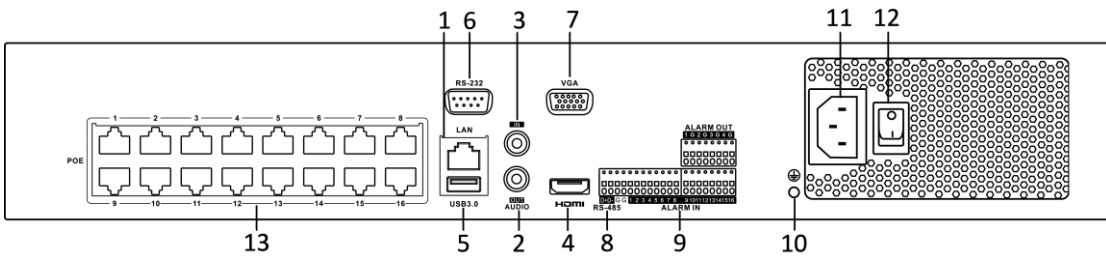

Figure 1-11 DS-7700NI-I4/16P Series

NOTE

The DS-7708NI-I4/8P provides 8 network Interfaces with PoE function.

Table 1-8 Panel Description

No.	Name	Description
1	LAN Interface	1 network interface provided for DS-7700NI-I4/P, and 2 network interfaces for DS-7700NI-I4.
2	AUDIO OUT	RCA connector for audio output.
3	LINE IN	RCA connector for audio input.
4	HDMI	HDMI video output connector.
5	USB 3.0 interface	Universal Serial Bus (USB) ports for additional devices such as USB mouse and USB Hard Disk Drive (HDD).
6	RS-232 Interface	Connector for RS-232 devices.
7	VGA	DB9 connector for VGA output. Display local video output and menu.
8	RS-485 Interface	Half-duplex connector for RS-485 devices.
9	ALARM IN	Connector for alarm input.

	ALARM OUT	Connector for alarm output.
10	GROUND	Ground (needs to be connected when device starts up).
11	AC 100V ~ 240V	100V to 240VAC power supply.
12	Power Switch	Switch for turning on/off the device.
13	Network Interfaces with PoE function (for DS-7700NI-I4/P)	Network interfaces for the cameras and to provide power over Ethernet.

Chapter 2 Getting Started

2.1 Start up the Device

Purpose:

Proper startup and shutdown procedures are crucial to expanding the life of the device.

Before you start:

Check that the voltage of the extra power supply is the same with the device's requirement, and the ground connection is working properly.

Start up the device:

- Step 1 Check the power supply is plugged into an electrical outlet. It is HIGHLY recommended that an Uninterruptible Power Supply (UPS) be used in conjunction with the device. The Power indicator LED on the front panel should be red, indicating the device gets the power supply.
- Step 2 Press the POWER button on the front panel. The Power indicator LED should turn blue indicating that the unit begins to start up.
- Step 3 After startup, the Power indicator LED remains blue. A splash screen with the status of the HDD appears on the monitor. The row of icons at the bottom of the screen shows the HDD status. 'X' means that the HDD is not installed or cannot be detected.

2.2 Activate the Device

Purpose:

For the first-time access, you need to activate the device by setting an admin password. No operation is allowed before activation. You can also activate the device via Web Browser, SADP or Client Software.

- Step 1 Input the same password in the text field of **Create New Password** and **Confirm New Password**.



You can click  to show the characters input.

admin

Strong

Export GUID (?)

Create Channel Default Password

Security Question C...

Note: Valid password range [8-16]. You can use a combination of numbers, lowercase, uppercase and special character for your password with at least two kinds of them contained.

OK

Figure 2-1 Activating the Device

 **WARNING**

We highly recommend you create a strong password of your own choosing (Using a minimum of 8 characters, including at least three of the following categories: upper case letters, lower case letters, numbers, and special characters.) in order to increase the security of your product. And we recommend you reset your password regularly, especially in the high security system, resetting the password monthly or weekly can better protect your product.

Step 2 In the **Create Channel Default Password** text field, create a default password of IP camera (s) connected to the device.

Step 3 (Optional) Check **Export GUID** and **Security Question Configuration**.

Export GUID: export the GUID for future password resetting.

Security Question Configuration: configure the security questions which can be used for resetting the password.

Step 4 Click **OK**.

What to do next:

- When you have enabled the **Export GUID**, continue to export the GUID file to the USB flash driver for the future password resetting.
- When you have enabled the **Security Question Configuration**, continue to set the security questions for the future password resetting.

 **NOTE**

- After the device is activated, you should properly keep the password.
- You can duplicate the password to the IP cameras that are connected with default protocol.

2.3 Configure Login Unlock Pattern

You can configure a device login unlock pattern for the admin user.

Step 1 After the device is activated, enter the following interface to configure the device unlock pattern.

Step 2 Use the mouse to draw a pattern among the 9 dots on the screen. Release the mouse when the pattern is done.

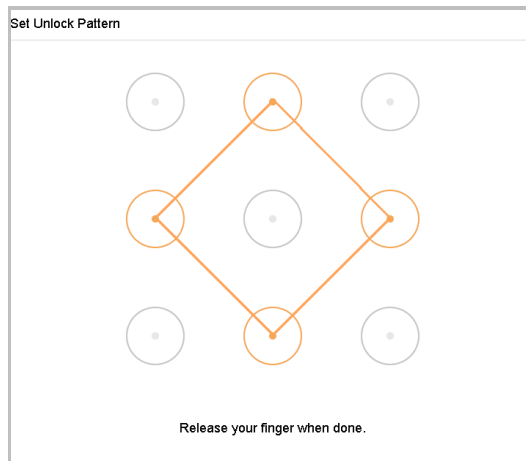

Figure 2-2 Draw the Pattern

 **NOTE**

- Connect at least 4 dots to draw the pattern.
- Each dot can be connected for once only.

Step 3 Draw the same pattern again to confirm it. When the two patterns match, the pattern is configured successfully.

 **NOTE**

If the two patterns are different, you must set the pattern again.

2.4 Login to the Device

2.4.1 Log in via Unlock Pattern



NOTE

Only the *admin* user has permission to unlock the device.

Before you Start

Configure the unlock pattern before unlocking. Refer to Chapter 2.3 Configure Login Unlock Pattern.

Step 1 Right click the mouse and select the menu to enter the interface.

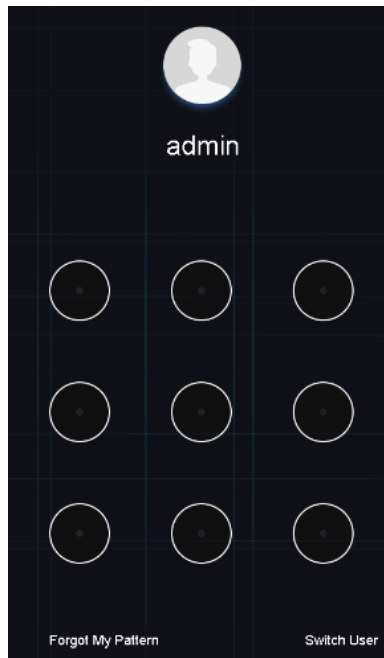

Figure 2-3 Draw the Unlock Pattern

Step 2 Draw the pre-defined pattern to unlock and enter the menu operation.



NOTE

- If you have forgotten your pattern, select **Forgot My Pattern** or **Switch User** to enter the normal login dialog box.
- If the pattern you draw is different from the pattern you configured, try again.
- If you draw the wrong pattern more than five times, the system will switch to the normal login mode automatically.

2.4.2 Log in via a Password

Purpose:

If the device has logged out, you must log in to the device before operating the menu and other functions.

Step 1 Select your **User Name** in the drop-down list.

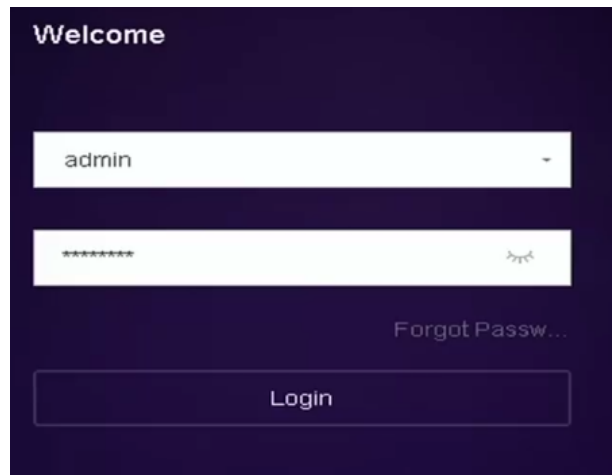

Figure 2-4 Login Interface

Step 2 Input password.

Step 3 Click **Login** to log in.

 **NOTE**

If you forget the admin password, click **Forgot Password** to reset the password.

 **NOTE**

In the Login dialog box, if you enter the wrong password 7 times, the current user account will be locked for 60 seconds.

2.5 Start Setup Wizard

The Setup Wizard walks you through some important basic device settings.

By default, the Setup Wizard starts once the device has loaded. If you don't want to use the Setup Wizard at that moment, click **Exit**.

Step 1 Set the date and time on the **Date and Time Setup** interface.

Date and Time Setup

Time Zone: (GMT+08:00) Beijing, Urumc

Date Format: DD-MM-YYYY

System Date: 10-10-2017

System Time: 16:12:33

Enable Wizard

Previous Next Exit

Figure 2-5 Date and Time Settings

Step 2 Set the basic network parameters on the **Network Setup** interface.

Network Setup

Working Mode: Net Fault-Tolerance

Select NIC: bond0

NIC Type: 10M/100M/1000M Self-adapl

Enable Obtain DNS Serv...

Preferred DNS Server:

Alternate DNS Server:

Main NIC: LAN1

Enable DHCP:

IPv4 Address: 10 . 15 . 1 . 19

IPv4 Subnet Mask: 255 . 255 . 255 . 0

IPv4 Default Gateway: 10 . 15 . 1 . 254

Previous Next Exit

Figure 2-6 Network Settings

Step 3 Select a HDD and click **Init** to initialize it as demand on the **Hard Disk** interface.

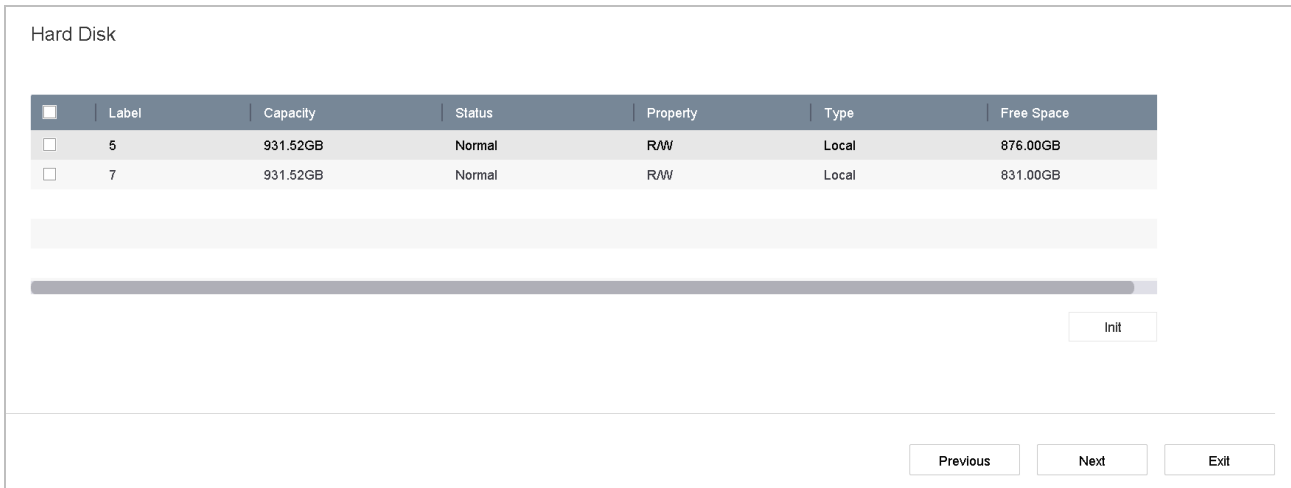

Figure 2-7 HDD Management

Step 4 Add IP cameras on the **Camera Setup** interface.

- 1) Click **Search** to search online IP camera. Before adding a camera, make sure the IP camera to be added is in active status.
- 2) Click **Add** to add the camera.

NOTE

If the camera is in inactive status, select the camera from the list and click **Activate**.

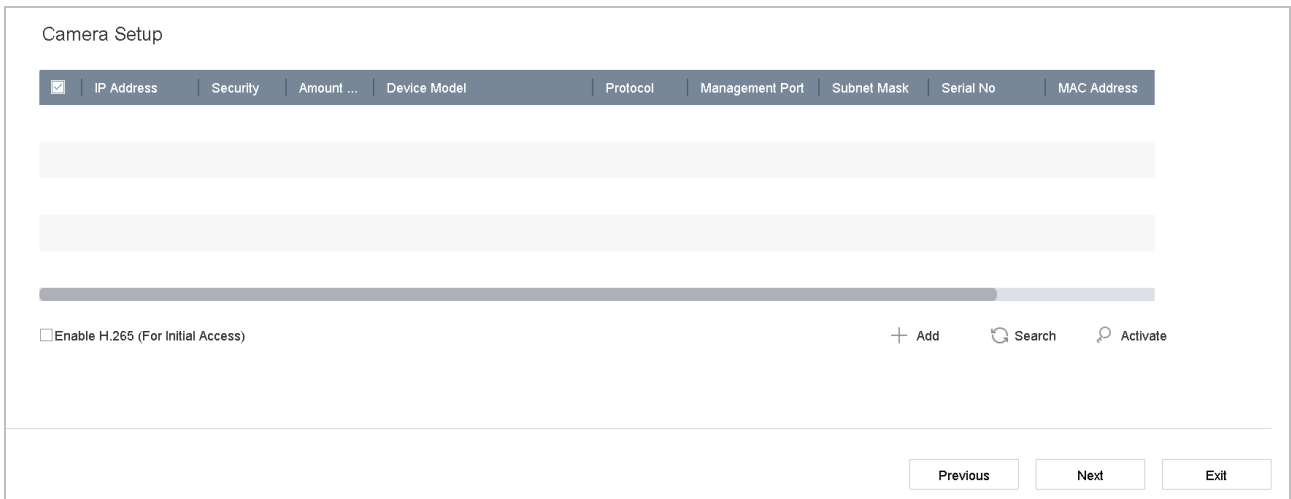

Figure 2-8 Search for IP Cameras

Step 5 Enter **Platform Access** interface and configure the Hik-Connect settings.

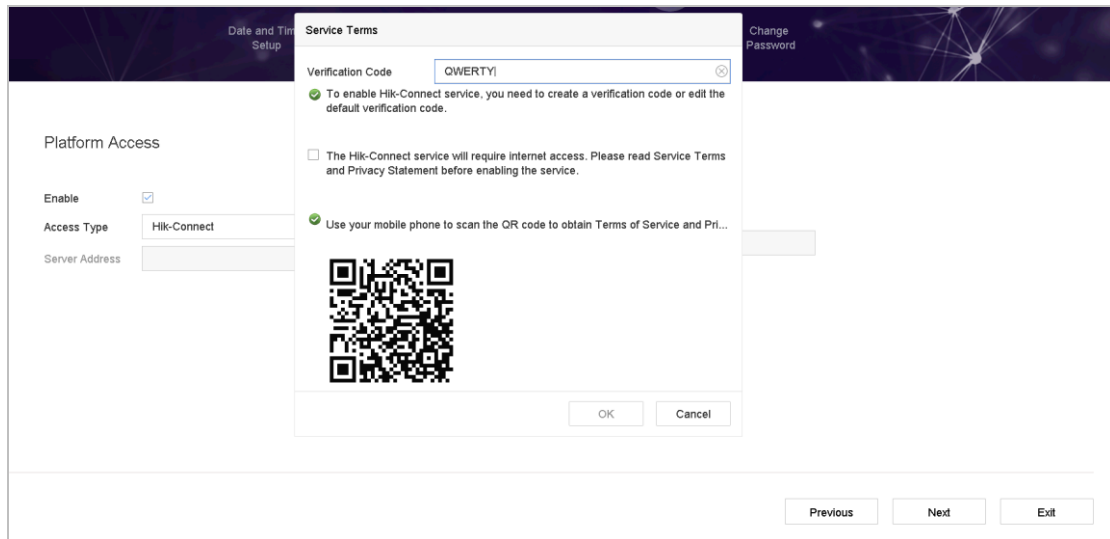



Figure 2-9 Hik-Connect Access

Step 6 Enter the **Change Password** interface to create a new admin password if required.



Figure 2-10 Change Password

 **NOTE**

You can enter click the  to show the characters input.

- 1) Check the **New Admin Password** checkbox.
- 2) Enter the original password in the **Admin Password** text field.
- 3) Input the same password in the **New Password** and **Confirm** text fields.
- 4) Check the **Unlock Pattern checkbox** to enable the login via unlock pattern.

 **WARNING**

We highly recommend you create a strong password of your own choosing (Using a minimum of 8 characters, including at least three of the following categories: upper case letters, lower case letters, numbers, and special characters.) in order to increase the security of your product. And we recommend you reset your password regularly, especially in the high security system, resetting the password monthly or weekly can better protect your product.

Step 7 Click **OK** to complete the startup Setup Wizard.







2.6 Enter Main Menu

After you have completed the wizard, you can right click on the screen to enter the main menu bar. Refer to the following figure and table for the description of main menu and sub-menus.



Figure 2-11 Main Menu Bar

Table 2-1 Description of Icons

Icon	Description
	Live View
	Playback
	File Management
	Smart Analysis
	Camera Management
	Storage Management
	System Management

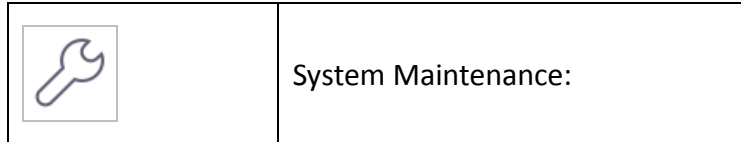

2.7 System Operation

2.7.1 Log out

Purpose:

After logging out, the monitor turns to live view mode. To perform any operations, you need to log in again.

Step 1 Click  on the menu bar.

Step 2 Click **Logout**.



After you log out of the system, menu operations on the screen are invalid. You must input a user name and password to unlock the system.

2.7.2 Shut Down the Device

Step 1 Click  on the menu bar.

Step 2 Click **Shutdown**.

Step 3 Click **Yes**.



Do not press POWER again when the system is shutting down.

2.7.3 Reboot the Device

From the Shutdown menu, you can also reboot the device.

Step 1 Click  on the menu bar.

Step 2 Click **Reboot** to reboot the device.

Chapter 3 Camera Management

3.1 Add IP Cameras

3.1.1 Add IP Cameras Manually

Purpose:

Before you can view live video or record video files, you must add the network cameras to the connection list of the device.

Before You Start:

Ensure the network connection is valid and the IP camera has been activated.

Step 1 Click  on the main menu bar to enter the Camera Management interface.

Step 2 Click the **Custom Add** tab on the title bar or click  in the idle channel window to enter the Add IP Camera interface.

Step 3 Enter IP address, protocol, management port, and other information.

Step 4 Enter the login user name and password of the IP camera.

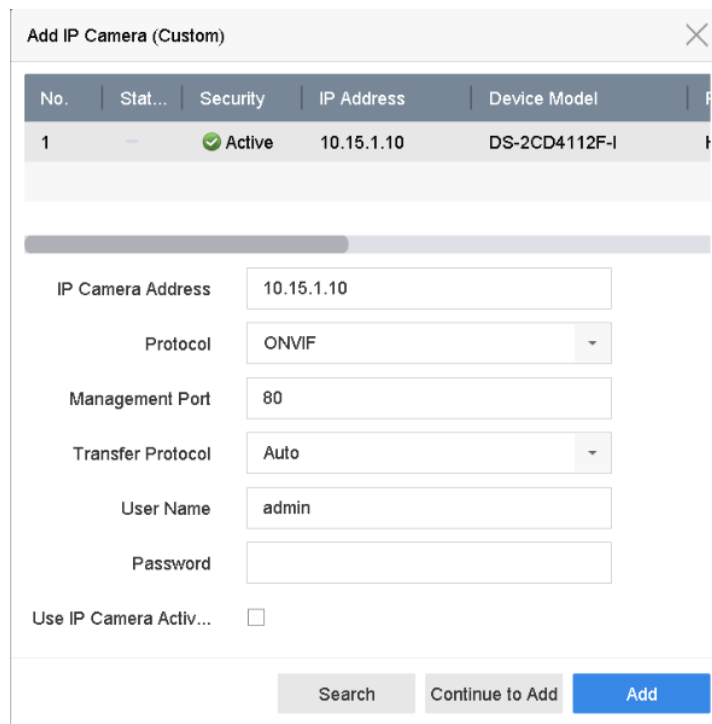

No.	Stat...	Security	IP Address	Device Model
1	Active	<input checked="" type="checkbox"/>	10.15.1.10	DS-2CD4112F-I

IP Camera Address: 10.15.1.10

Protocol: ONVIF

Management Port: 80

Transfer Protocol: Auto

User Name: admin

Password:

Use IP Camera Activ...

Buttons: Search, Continue to Add, Add

Figure 3-1 Add IP Camera

Step 5 Click **Add** to finish adding the IP camera.

Step 6 (Optional) Click **Continue to Add** to continue to add other IP cameras.

3.1.2 Add the Automatically Searched Online IP Cameras

Step 1 On the Camera Management interface, click the **Online Device** panel to expand the Online Device interface.

Step 2 Select the automatically searched online device.

Step 3 Click **Add** to add the camera which has the same login password with the device.

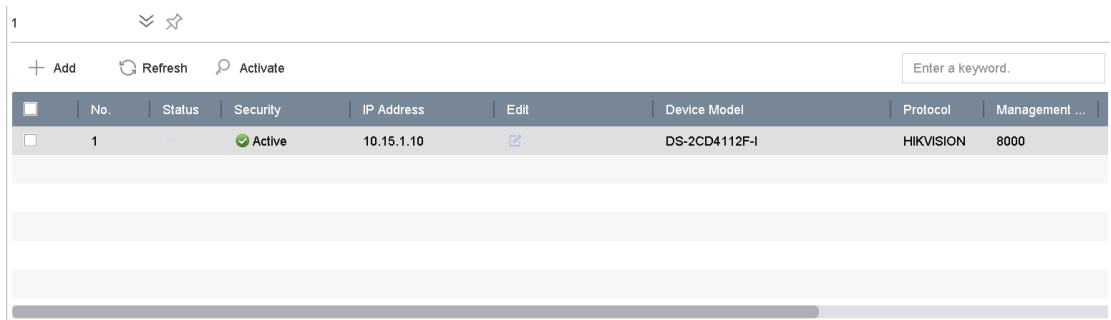

Figure 3-2 Add IP Camera

NOTE

If the IP camera to add has not been activated, you can activate it from the IP camera list on the camera management interface.

3.2 Manage Cameras for PoE Device

NOTE

This chapter is only applicable for the following models: DS-7600NI-I2/P and DS-7700NI-I4/P series device.

Purpose:

The PoE interfaces enables the device system to pass electrical power safely, along with data, on Ethernet cabling to the connected PoE cameras. Supported PoE camera number varies with device model

If you disable the PoE interface, you can also connect to the online network cameras. And the PoE interface supports the Plug-and-Play function.

For example, for DS-7608NI-I2/8P, if you want to connect 6 network cameras via PoE interfaces and 2 online cameras, you must disable 2 PoE interfaces in the Edit IP Camera menu.

Follow the steps to add network cameras for device supporting PoE function.

3.2.1 Add PoE Cameras

Step 1 Connect PoE cameras to device PoE ports with network cables.

Step 2 Go to **Camera > Camera > IP Camera** to view camera image and information.

3.2.2 Add Non-PoE IP Cameras

You can disable the PoE interface by selecting the manual while the current channel can be used as a normal channel and the parameters can also be edited.

Step 1 Go to **Camera > Camera > IP Camera**.

Step 2 Position the cursor on a window with no linked IP camera and click the  button.

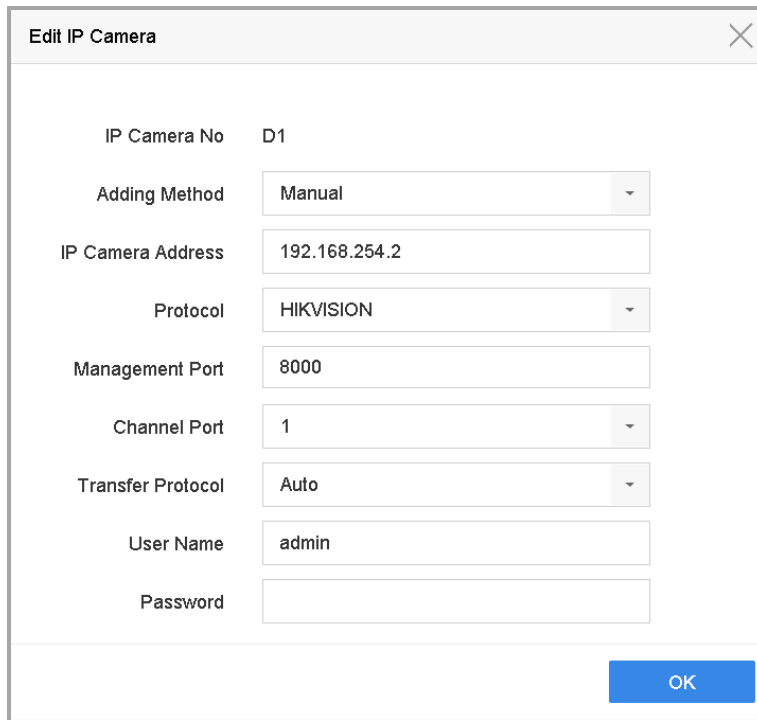

Figure 3-3 Edit IP Camera

Step 3 Select Adding Method as **Manual**.

- **Plug-and-Play:** The camera is physically connected to the PoE interface. Its parameters cannot be edited. You can go to **System > Network > TCP/IP** to change IP address of PoE port.
- **Manual:** Add IP camera without physical connection via network.

Step 4 Enter the IP address, the user name and password of administrator manually.

Step 5 Click **OK**.

3.2.3 Configure PoE Interface

Purpose:

When it requires long-distance PoE transmission (100 to 300 m), you can enable long distance mode for the PoE channel.

Step 1 Go to **Camera > Camera >PoE Settings**.

Step 2 Enable or disable long network cable mode by selecting **Long Distance** or **Short Distance** radio.

- **Long Distance:** Long-distance (100 to 300 meters) network transmissions via PoE interface.
- **Short Distance:** Short-distance (< 100 meters) network transmission via PoE interface.

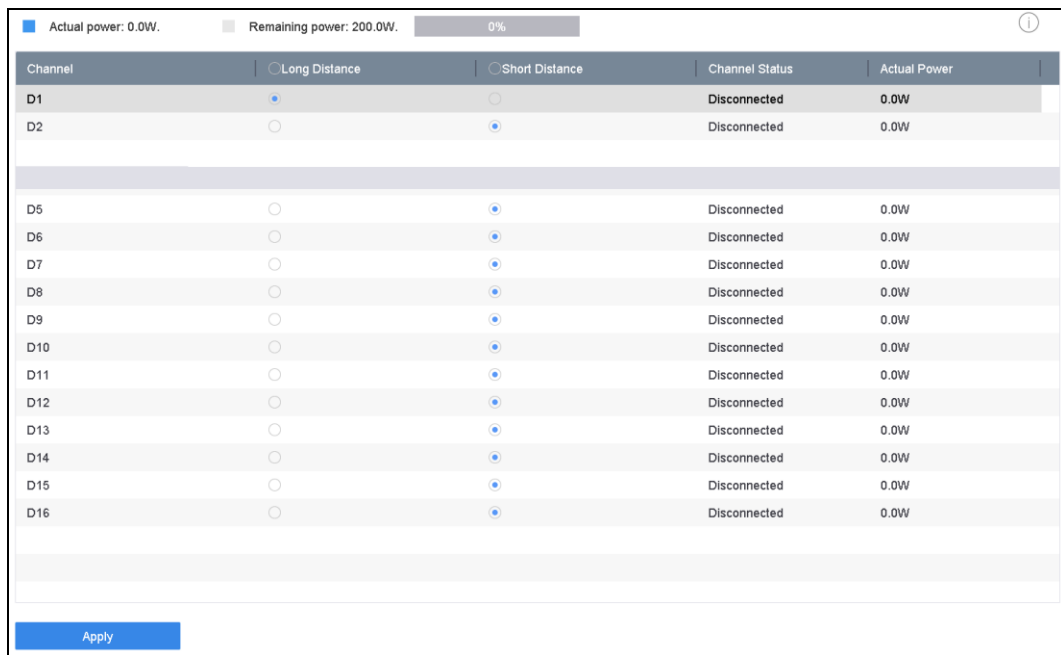

Figure 3-4 PoE Settings

 **NOTE**

- The PoE ports are enabled with the short distance mode by default.
- The bandwidth of IP camera connected to the PoE via long network cable (100 to 300 meters) cannot exceed 6 MP.
- The allowed max. long network cable may be less than 300 meters depending on different IP camera models and cable materials.
- When the transmission distance reaches 100 to 250 meters, you must use the CAT5E or CAT6 network cable to connect with the PoE interface.
- When the transmission distance reaches 250 to 300 meters, you must use the CAT6 network cable to connect with the PoE interface.
- Refer to the Appendix 20.4 List of IP Cameras Connected to PoE by Long Network Cable (100 - 300 m) for the list of IP cameras.

Step 3 Click **Apply**.

3.3 Enable the H.265 Stream Access

The device can automatically switch to the H.265 stream of IP camera (which supports H.265 video format) for the initial access.

Step 1 Go to **More Settings > H.265 Auto Switch Configuration** at the top taskbar.

Step 2 Check the checkbox of **Enable H.265 (For Initial Access)**.

Step 3 Click **OK**.

3.4 Upgrade the IP Camera

The IP camera can be remotely upgraded through the device.

 **NOTE**

Plug the U-flash drive with the IP camera's firmware upgrade file to the device.

Step 1 On the camera management interface, select a camera.

Step 2 Go to **More Settings > Upgrade** at the top taskbar.

Step 3 Select the firmware upgrade file from the U-flash drive.

Step 4 Click **Upgrade**.

Result:

The IP camera will reboot automatically after the upgrading completes.

3.5 Configure the Customized Protocols

Purpose

To connect the network cameras which are not configured with the standard protocols, you can configure the customized protocols for them. The system provides 16 customized protocols.

Step 1 Go to **More Settings > Protocol** at the top taskbar to enter the protocol management interface.

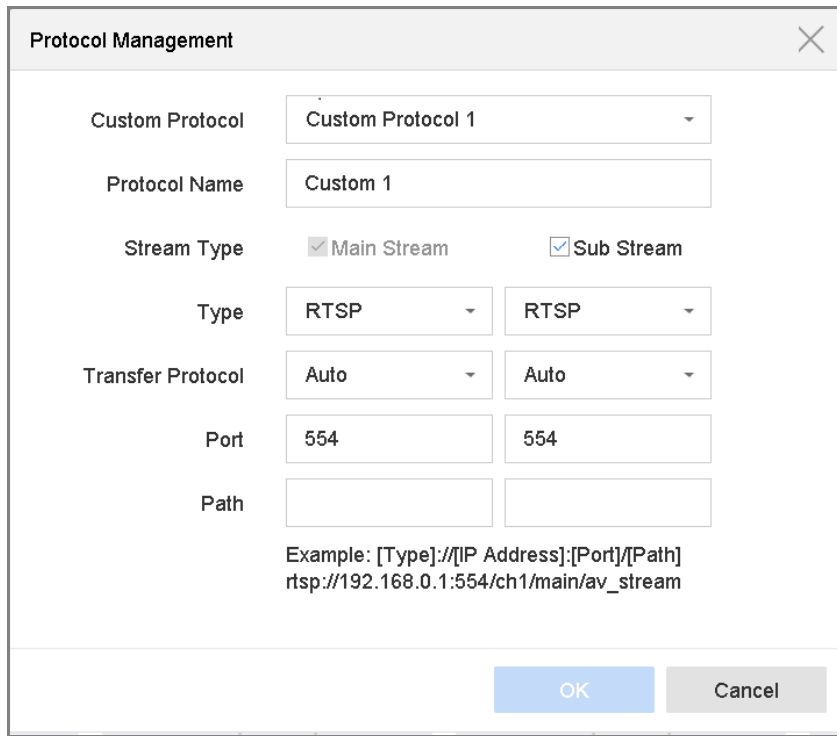

Figure 3-5 Protocol Management

Step 2 Select the protocol type of transmission and choose the transfer protocols.

- **Type:** The network camera adopting custom protocol must support getting stream through standard RTSP.
- **Path:** you have to contact the manufacturer of the network camera to consult the URL (uniform resource locator) for getting main stream and sub-stream.
- The format of the URL is: [Type]://[IP Address of the network camera]:[Port]/[Path].
- **Example:** rtsp://192.168.1.55:554/ch1/main/av_stream.

 **NOTE**

The protocol type and the transfer protocols must be supported by the connected IP camera.

Step 3 Click **OK** to save the settings.

Result:

After adding the customized protocols, you can see the protocol name is listed in the drop-down list.

Chapter 4 Camera Settings

4.1 Configure OSD Settings

Purpose

You can configure the OSD (On-screen Display) settings for the camera, including date/time, camera name, etc.

Step 1 Go to **Camera >Display**.

Step 2 Select the camera from the drop-down list.

Step 3 Edit the name in **Camera Name**.

Step 4 Check **Display Name**, **Display Date** and **Display Week** to show the information on the image.

Step 5 Set the date format, time format, and display mode.

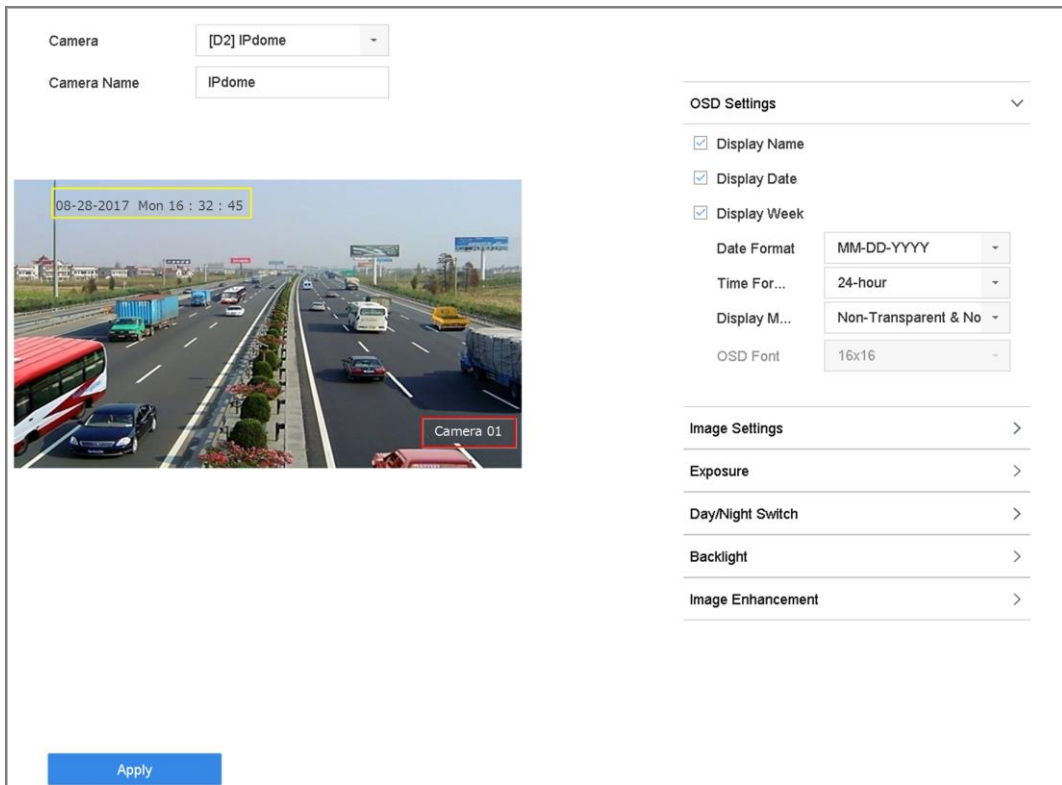

Figure 4-1 OSD Configuration Interface

Step 6 Use the mouse to click and drag the text frame on the preview window to adjust the OSD position.

Step 7 Click **Apply**.

4.2 Configure Privacy Mask

Purpose

The privacy mask protects personal privacy by concealing parts of the image from view or recording with a masked area.

Step 1 Go to **Camera >Privacy Mask**.

Step 2 Select the camera to set privacy mask.

Step 3 Click **Enable** to enable this feature.

Step 4 Use the mouse to draw a zone on the window. The zones will be marked by different frame colors.

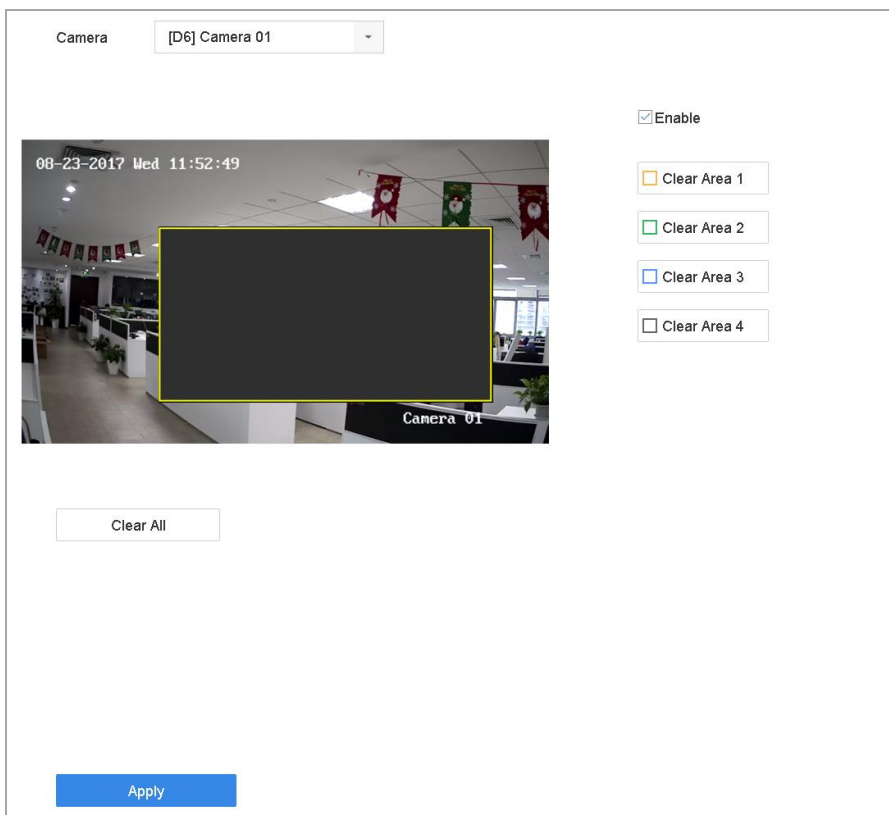

Figure 4-2 Privacy Mask Settings Interface

NOTE

Up to 4 privacy masks zones can be configured and the size of each area can be adjusted.

Related Operation:

Clear the configured privacy mask zones on the window by clicking the corresponding Clear Zone1-4 icons on the right of the window, or click **Clear All** to clear all zones.

Step 5 Click **Apply**.

4.3 Configure the Image Parameters

Purpose

You can customize the image parameters including the brightness, contrast, and saturation for the Live View and recording effect.

Step 1 Go to **Camera>Display > Image Settings**.

Step 2 Select a camera from the drop-down list.

Step 3 Adjust the slider or click on the up/down arrow to set the value of the brightness, contrast, or saturation.

Step 4 Click **Apply**.

4.4 Configure the Day/Night Switch

The camera can be set to day, night, or auto switch mode according to the surrounding illumination conditions.

Step 1 Go to **Camera>Display > Day/Night Switch**.

Step 2 Select the camera from the drop-down list.

Step 3 Set the day/night switch mode to **Day, Night, Auto, or Auto-Switch**.

Auto: The camera automatically switches between day mode and night mode according to the illumination.

The sensitivity ranges from 0 to 7, and higher sensitivity more easily triggers the mode switch.

The switch time refers to the interval time between the day/night switch. You can set it from 5 sec to 120 sec.

Auto-Switch: The camera switches the day mode and the night mode according to the start time and end time you set.

Step 4 Click the **Apply**.

4.5 Configure Other Camera Parameters

For a connected camera, you can configure the camera parameters including the exposure mode, backlight and image enhancement.

Step 1 Go to **Camera>Display**.

Step 2 Select a camera from the drop-down list.

Step 3 Configure the camera parameters.

- Exposure: Set the camera exposure time (1/10000 to 1 sec). A larger exposure value results in a brighter image.
- Backlight: Set the camera's wide dynamic range (0 to 100). When the surrounding illumination and the object have large differences in brightness, you should set the WDR value.
- Image Enhancement: For optimized image contrast enhancement.

Step 4 Click **Apply**.

Chapter 5 Live View

Live View displays the video image getting from each camera in real time.

5.1 Start Live View

Click  on the main menu bar to enter the Live View.

- Select a window and double click a camera from the list to play the video from the camera in the selected window.
- Use the toolbar at the playing window bottom to realize the capture, instant playback, audio on/off, digital zoom, live view strategy, show information and start/stop recording, etc.

5.1.1 Digital Zoom

Digital Zoom zooms into the live image in different magnifications (1x to 16x).

Step 1 In the Live View mode, click  from the toolbar to enter the digital zoom interface.

Step 2 Move the sliding bar or scroll the mouse wheel to zoom in/out the image to different magnifications (1x to 16x).



Figure 5-1 Digital Zoom

5.1.2 Fisheye View





The device supports the fisheye camera expansion in Live View or playback mode.

 **NOTE**

- The fisheye expansion view feature is supported only by the DS-7600/7700/9600-I (/P) Series.
- The connected camera must support the fisheye view.

Step 1 In the Live View mode, click  to enter the fisheye expansion mode.

Step 2 Select the expansion view mode.

- **180° Panorama** (): Switch the Live View image to the 180° panorama view.
- **360° Panorama** (): Switch the Live View image to the 360° panorama view.
- **PTZ Expansion** (): The PTZ Expansion is the close-up view of some defined area in the fisheye view or panorama expansion. It supports the electronic PTZ function, also called e-PTZ.
- **Radial Expansion** (): In radial expansion mode, the whole wide-angle view of the fisheye camera is displayed. This view mode is called Fisheye View because it approximates the vision of a fish's convex eye. The lens produces curvilinear images of a large area, while distorting the perspective and angles of objects in the image.

5.1.3 3D Positioning

3D Positioning zooms in/out of a specific live image area.

Step 1 In Live View mode, click the  to enter the 3D positioning mode.

Step 2 Zoom in/out of the image.

- **Zoom In**

Use the left mouse key to click on the desired position in the video image and drag a rectangle area in the lower right direction to zoom in.

- **Zoom Out**

Use the left mouse key to drag a rectangle area in the upper left direction to move the position to the center and enable the rectangle area to zoom out.

5.1.4 Live View Strategy





Step 1 In Live View mode, click  to enter the digital zoom operation interface in full screen mode.

Step 2 Select the Live View strategy to **Real-time**, **Balanced** or **Fluency**.

5.2 Target Detection

In Live View mode, the target detection function can detect a human motion/face/vehicle/human body during the last 5 seconds and the following 10 seconds.

Step 1 In Live View mode, click **Target Detection** to enter the target detection interface.

Step 2 Check the checkbox to select different detection types: motion detection (), vehicle detection (), face detection (), and human body detection ().



Step 3 Select the historical analysis () or real-time analysis () to obtain the results.



Figure 5-2 Target Detection

Step 4 The smart analysis results of the detection are displayed in the list. Optionally, click a result in list to play the related video.

5.3 Configure Live View Settings

Live View settings can be customized. You can configure the output interface, dwell time for screen to be shown, mute or turning on the audio, the screen number for each channel, etc.

Step 1 Go to **System > Live View > General**.

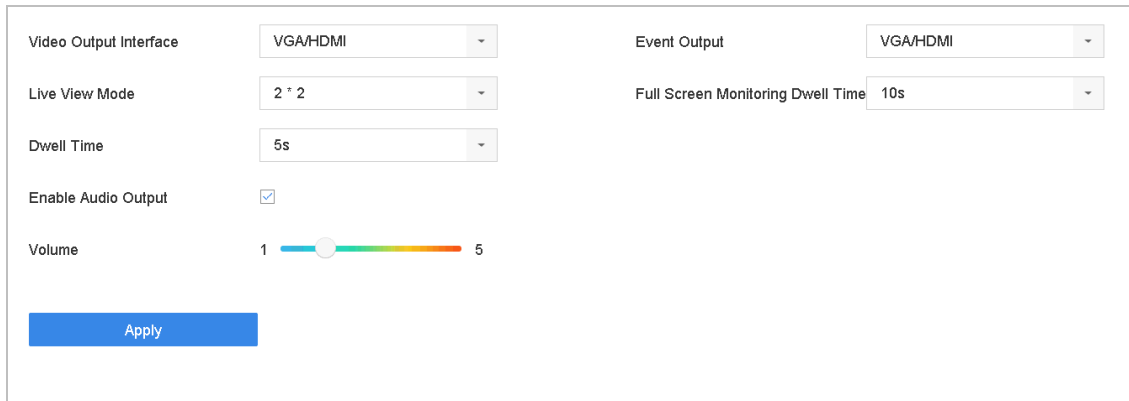

Figure 5-3 Live View-General

Step 2 Configure the Live View parameters.

- **Video Output Interface:** Select the video output to configure.
- **Live View Mode:** Select the display mode for Live View, e.g., 2*2, 1*5, etc.
- **Dwell Time:** The time in seconds to wait between switching of cameras when using auto-switch in Live View.
- **Enable Audio Output:** Enable/disable audio output for the selected video output.
- **Volume:** Adjust the Live View volume, playback and two-way audio for the selected output interface.
- **Event Output:** Select the output to show event video.
- **Full Screen Monitoring Dwell Time:** Set the time in seconds to show alarm event screen.

Step 3 Click **OK**.

5.4 Configure Live View Layout

5.4.1 Configure Custom Live View Layout

Step 1 Go to **System > Live View > View**.

Step 2 Click **Set Custom Layout**.

Step 3 Click  on the Custom Layout Configuration interface.

Step 4 Edit the layout name.

Step 5 Select a window division mode from the toolbar.

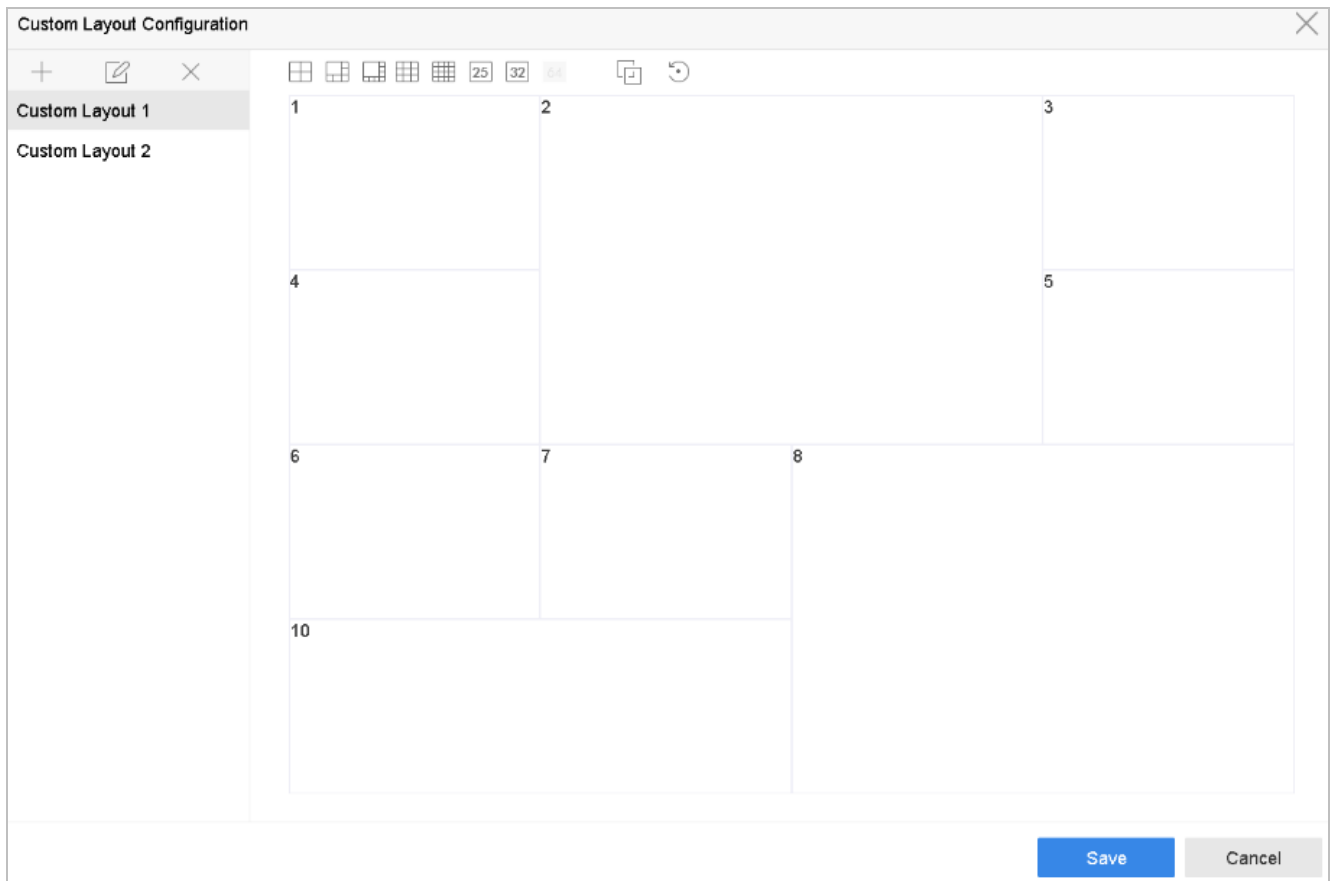



Figure 5-4 Configure Live View Layout



Step 6 Select multiple windows and click  to joint the windows. The selected windows must be in rectangle area.

Step 7 Click **Save**.

Result:

The successfully configured view layout is displayed in the list.

Related Operations:

- Select a live view layout from the list and click  to edit the name.
- Select a live view layout from the list and click  to delete the name.

5.4.2 Configure Live View Mode

Step 1 Go to **System > Live View > View**

Step 2 Select the video output interface.

Step 3 Select a constant window-division layout or custom layout from the toolbar.

Step 4 Select a division window, and double-click on a camera in the list to link the camera to the window.

You can enter the number in the text field to quickly search the camera from the list.





NOTE

You can also click-and-drag the camera to the desired window on the Live View interface to set the camera order.

Step 5 Click **Apply**.

Related Operations:

- Click  to start Live View for all channels.
- Click  to stop all Live View channels.

5.5 Configure Camera Auto-Switch

You can set the camera's auto-switch to play in different display modes.

Step 1 Go to **System > Live View > General**.

Step 2 Set the video output interface, Live View mode and dwell time.

- **Video Output Interface:** Select the video output interface.
- **Live View Mode:** Select the display mode for Live View, e.g., 2*2, 1*5, etc.
- **Dwell Time:** The time in seconds to wait between switching of cameras when in auto-switch. The range is from 5s to 300s.

Step 3 Go to **View Settings** to set the view layout.

Step 4 Click **OK**.

5.6 Configure Channel-Zero Encoding

Purpose

Enable the channel-zero encoding when you need to get a remote view of many channels in real time from a web browser or CMS (Client Management System) software, in order to decrease the bandwidth requirement without affecting the image quality.

Step 1 Go to **System>Live View>General**.

Step 2 Set the video output interface to **Channel-Zero**.

Step 3 Go to **System>Live View>Channel-Zero**.

Step 4 Check **Enable Channel-Zero Encoding**.

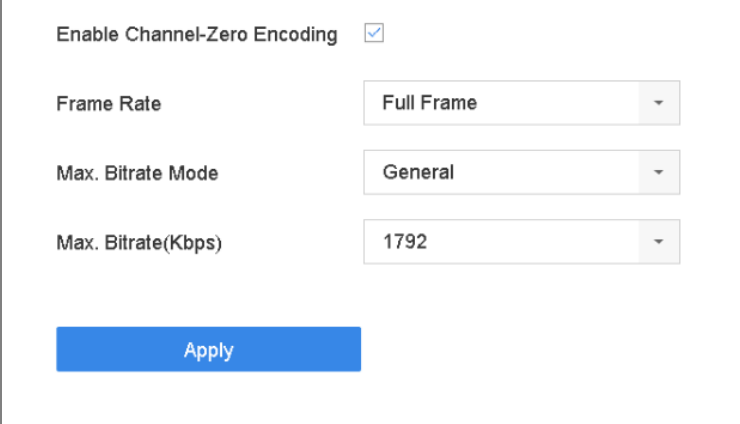

Enable Channel-Zero Encoding

Frame Rate

Max. Bitrate Mode

Max. Bitrate(Kbps)

Figure 5-5 Live View, Channel-Zero Encoding

Step 5 Configure the **Frame Rate**, **Max. Bitrate Mode**, and **Max. Bitrate**. The higher frame rate and bitrate settings result in higher bandwidth requirement.

Step 6 Click **Apply**.

Result:

You can view all of the channels on one screen using the CMS or a web browser.

Chapter 6 PTZ Control

6.1 PTZ Control Wizard

Before You Start

Make sure the connected IP camera supports the PTZ function and is properly connected.

Purpose

Follow the PTZ Control Wizard to guide you through the basic PTZ operation.

Step 1 Click  on the quick settings toolbar of the PTZ camera live view. The PTZ control wizard pops up as below.



Figure 6-1 PTZ Control Wizard

Step 2 Follow the PTZ Control Wizard to adjust the PTZ view, focus, and zoom in/out.

Step 3 (Optional) Check ***Do not show this prompt again.***

Step 4 Click **OK.**

6.2 Configure PTZ Parameters

Purpose

Follow these procedures to set the PTZ parameters. The PTZ parameters configuration must be done before you can control the PTZ camera.

Step 1 Click  on the quick settings toolbar of the PTZ camera's Live View. The PTZ control panel displays on the right of the interface.

Step 2 Click **PTZ Parameters Settings** to set the PTZ parameters.

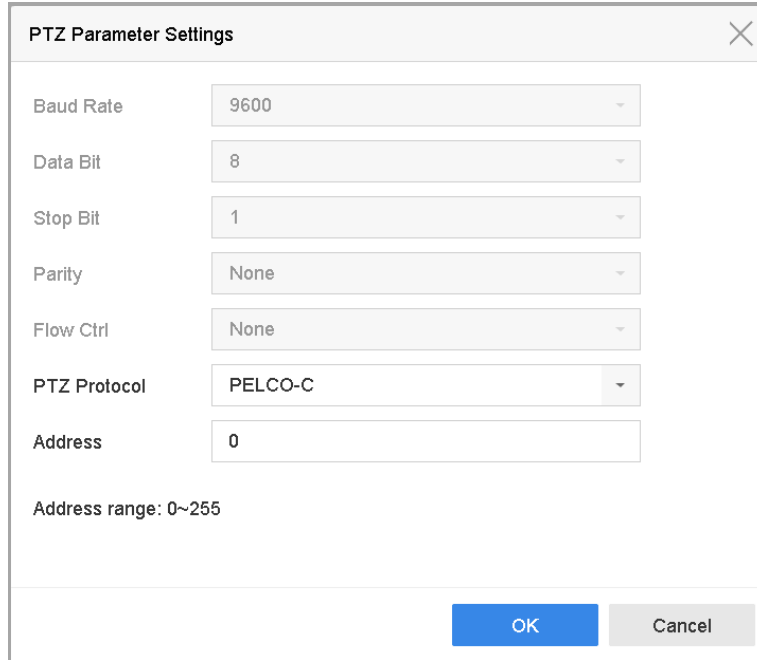

Figure 6-2 PTZ Parameters Settings

Step 3 Edit the PTZ camera parameters.

 **NOTE**

All the parameters should be exactly match the PTZ camera parameters.

Step 4 Click **OK** to save the settings.

6.3 Set PTZ Presets, Patrols, and Patterns

Before You Start

Make sure that the presets, patrols, and patterns are supported by PTZ protocols.

6.3.1 Set Presets

Purpose

Follow these steps to set the preset location that you want the PTZ camera to point to when an event takes place.

Step 1 Click  on the quick settings toolbar of the PTZ camera's live view.

Step 2 The PTZ control panel displays on the right of the interface.

Step 3 Use the directional buttons on the PTZ control panel to wheel the camera to the location where you want to set a preset, and the zoom and focus operations can be recorded in the preset as well.

Step 4 Click  in the lower right corner of Live View to set the preset.



Figure 6-3 Set Preset

Step 5 Select the preset No. (1 to 255) from the drop-down list.

Step 6 Enter the preset name in the text field.

Step 7 Click **Apply** to save the preset.

Step 8 Repeat steps 2-6 to save more presets.

Step 9 (Optional) Click **Cancel** to cancel the location information of the preset.

Step 10 (Optional) Click  in the lower right corner of Live View to view the configured presets.



Figure 6-4 View the Configured Presets

6.3.2 Call Presets

Purpose

A presets enables the camera to point to a specified position such as a window when an event takes place.

Step 1 Click  on the quick settings toolbar of the PTZ camera Live View.

Step 2 Click  in the lower right corner of Live View.

Step 3 Select the preset No. from the drop-down list.

Step 4 Click **Call** to call it, or click  in the lower right corner of Live View, and click the configured preset to call it.

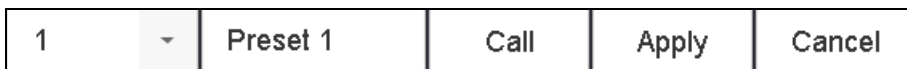

Figure 6-5 Call Preset (1)

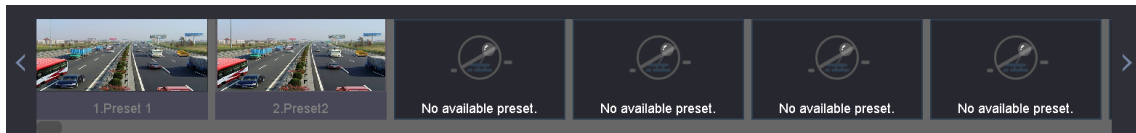



Figure 6-6 Call Preset (2)

6.3.3 Set Patrols

Purpose

Patrols can be set to move the PTZ to key points and have it stay there for a set duration before moving on to the next key point. The key points correspond to the presets.

- Step 1 Click  on the quick settings toolbar of the PTZ camera's Live View.
- Step 2 The PTZ control panel displays on the right of the interface.
- Step 3 Click **Patrol** to configure patrol.

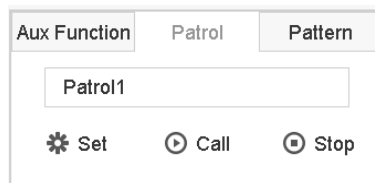

Figure 6-7 Patrol Configuration

- Step 4 Select the patrol No. in the text field.
- Step 5 Click **Set** to enter the Patrol Settings interface.

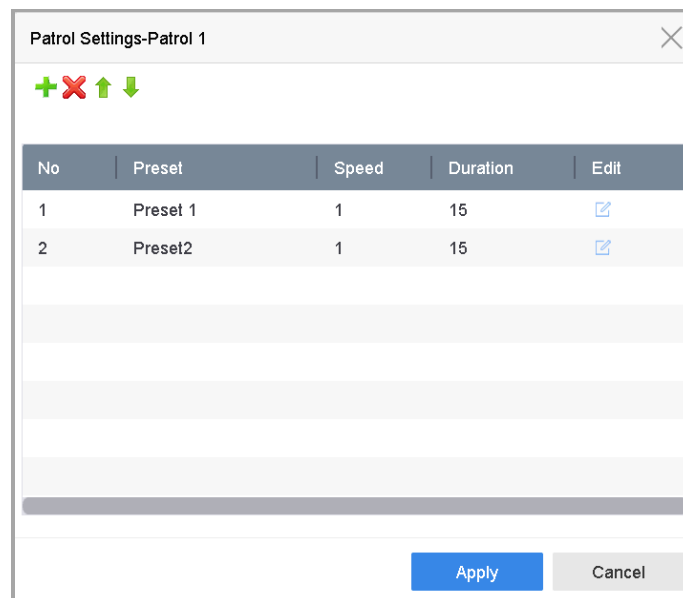



Figure 6-8 Patrol Settings

- Step 6 Click  to add a key point to the patrol.

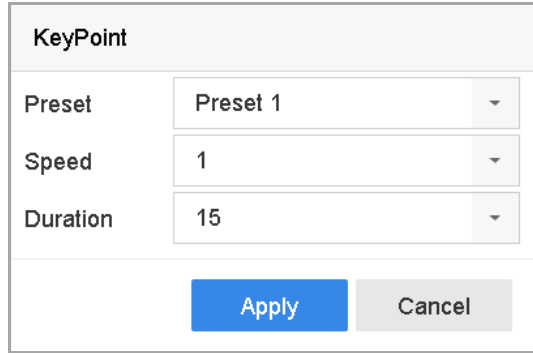

Figure 6-9 Key Point Configuration

1) Configure key point parameters.

Preset: Determines the order the PTZ will follow while cycling through the patrol.

Speed: Defines the speed the PTZ will move from one key point to the next.

Duration: Refers to the duration to stay at the corresponding key point.

2) Click **Apply** to save the key points to the patrol.

Step 7 (Optional) Click  to edit the added key point.

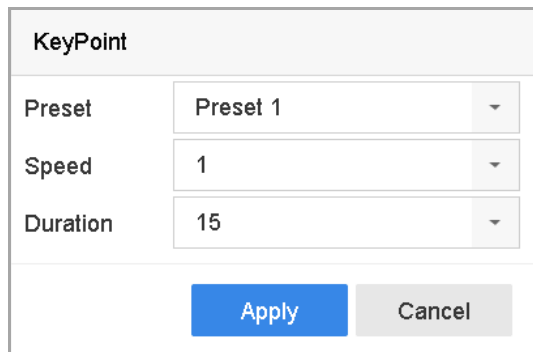



Figure 6-10 Edit Key Point

Step 8 (Optional) Select a key point and click  to delete it.

Step 9 (Optional) Click  or  to adjust the key point order.

Step 10 Click **Apply** to save the patrol settings.

Step 11 Repeat steps 3-9 to set more patrols.

6.3.4 Call a Patrol

Purpose

Calling a patrol makes the PTZ move according to the predefined patrol path.

Step 1 Click  on the quick settings toolbar of the PTZ camera's Live View.

The PTZ control panel displays on the right of the interface.

Step 2 Click **Patrol** on the PTZ control panel.

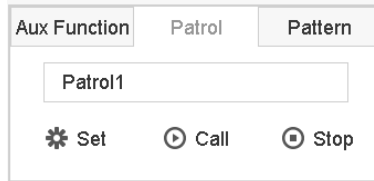

Figure 6-11 Patrol Configuration

Step 3 Select a patrol in the text field.

Step 4 Click **Call** to start the patrol.

Step 5 (Optional) Click **Stop** to stop the patrol.

6.3.5 Set a Pattern

Purpose

Patterns can be set by recording the movement of the PTZ. You can call the pattern to make the PTZ move according to the predefined path.

Step 1 Click  on the quick settings toolbar of the PTZ camera's Live View.

The PTZ control panel displays on the right of the interface.

Step 2 Click **Pattern** to configure a pattern.

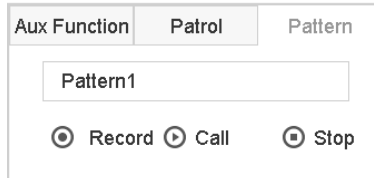

Figure 6-12 Pattern Configuration

Step 3 Select the pattern No. in the text field.

Step 4 Set the pattern.

- 1) Click **Record** to start recording.
- 2) Click corresponding buttons on the control panel to move the PTZ camera.
- 3) Click **Stop** to stop recording. The PTZ movement is recorded as the pattern.

Step 5 Repeat steps 3-4 to set more patterns.

6.3.6 Call a Pattern

Purpose

Follow the procedure to move the PTZ camera according to the predefined patterns.

Step 1 Click  on the quick settings toolbar of the PTZ camera's Live View.

Step 2 The PTZ control panel displays on the right of the interface.

Step 3 Click **Pattern** to configure pattern.

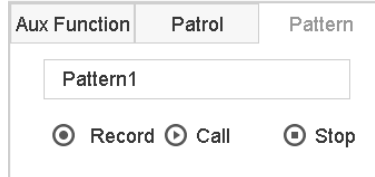

Figure 6-13 Pattern Configuration

Step 4 Select a pattern in the text field.

Step 5 Click **Call** to start the pattern.

Step 6 (Optional) Click **Stop** to stop the pattern.

6.3.7 Set Linear Scan Limits

Before You Start

Make sure the connected IP camera supports the PTZ function and is properly connected.

Purpose

Linear Scan trigger a scan in the horizontal direction in the predefined range.

NOTE

This function is supported only by some certain models.

Step 1 Click  on the quick settings toolbar of the PTZ camera's Live View.

Step 2 The PTZ control panel displays on the right of the interface.

Step 3 Click the directional buttons to wheel the camera to the location of where you want to set the limit, and click **Left Limit** or **Right Limit** to link the location to the corresponding limit.

NOTE

The speed dome linear scans from the left limit to the right limit, and you must set the left limit on the left side of the right limit. Also, the angle from the left limit to the right limit must be no more greater than 180°.

6.3.8 Call Linear Scan



Before operating this function, make sure the connected camera supports the linear scan and is in HIKVISION protocol.

Purpose

Follow the procedure to call the linear scan in the predefined scan range.

- Step 1 Click  on the quick settings toolbar of the PTZ camera's Live View.
- Step 2 The PTZ control panel displays on the right of the interface.
- Step 3 Click **Linear Scan** to start the linear scan and click it again to stop it.
- Step 4 (Optional) Click **Restore** to clear the defined left limit and right limit data.



Reboot the camera to have the settings take effect.

6.3.9 One-Touch Park



Before operating this function, make sure the connected camera supports linear scan and is in HIKVISION protocol.

Purpose

Certain speed dome models can be configured to start a predefined park action (scan, preset, patrol and etc.) automatically after a period of inactivity (park time).

- Step 1 Click  on the quick settings toolbar of the PTZ camera's Live View.
The PTZ control panel displays on the right of the interface.
- Step 2 Click **Park (Quick Patrol)**, **Park (Patrol 1)**, or **Park (Preset 1)** to activate the park action.

Park (Quick Patrol): The dome starts patrolling from the predefined preset 1 to preset 32 in order after the park time. Undefined presets will be skipped.

Park (Patrol 1): The dome starts moving according to the predefined patrol 1 path after the park time.

Park (Preset 1): The dome moves to the predefined preset 1 location after the park time.

 **NOTE**

The park time can be set only via the speed dome configuration interface. The default value is 5s by default.

Step 3 Click **Stop Park (Quick Patrol)**, **Stop Park (Patrol 1)**, or **Stop Park (Preset 1)** to inactivate it.

6.4 Auxiliary Functions

Before You Start

Make sure the connected IP camera supports the PTZ function and is properly connected.

Purpose

You can operate the auxiliary functions including light, wiper, 3D positioning, and center on the PTZ control panel.

Step 1 Click  on the quick settings toolbar of the PTZ camera's Live View.

Step 2 The PTZ control panel displays on the right of the interface.

Step 3 Click **Aux Function**.

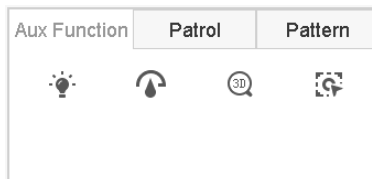





Figure 6-14 Aux Function Configuration

Step 4 Click the icons to operate the aux functions. See the table for the icon descriptions.

Table 6-1 Description of Aux Functions Icons

Icon	Description
	Light on/off
	Wiper on/off
	3D positioning
	Center

Chapter 7 Storage

7.1 Storage Device Management

7.1.1 Install the HDD

Before starting the device, install and connect an HDD to the device. Refer to the Quick Start Guide for the installation instructions.

7.1.2 Add the Network Disks

You can add the allocated NAS or IP SAN disk to the device, and use it as a network HDD. Up to 8 network disks can be added.

Adding a NAS

- Step 1 Go to **Storage > Storage Device**.
- Step 2 Click **Add** to enter the Custom Add interface.
- Step 3 Select NetHDD from the drop-down list.
- Step 4 Set the type to NAS.
- Step 5 Enter the NetHDD IP address in the text field.
- Step 6 Click **Search** to search the available NAS disks.

The screenshot shows a 'Custom Add' dialog box with the following fields and values:

- NetHDD:** A dropdown menu with 'NetHDD 1' selected.
- Type:** A dropdown menu with 'NAS' selected.
- NetHDD IP:** A text field containing '120 . 36 . 2 . 39'.
- NetHDD Directory:** A text field containing '/nas/device1/11|' and a search button.

At the bottom of the dialog are 'OK' and 'Cancel' buttons.

Figure 7-1 Add NAS Disk

Step 7 Select the NAS disk from the list shown below, or manually enter the directory in the NetHDD Directory text field.

Step 8 Click the **OK** to complete the adding of the NAS disk.

Result:

After successfully adding the NAS disk, return to the HDD Information menu. The added NetHDD will be displayed in the list.

Adding an IP SAN

Step 1 Go to **Storage > Storage Device**.

Step 2 Click **Add** to enter the Custom Add interface.

Step 3 Select NetHDD from the drop-down list.

Step 4 Select the type to IP SAN.

Step 5 Enter the NetHDD IP address in the text field.

Step 6 Click **Search** to search the available IP SAN disks.

Step 7 Select the IP SAN disk from the list.

Step 8 Click **OK** to complete adding IP SAN disk.



A single IP SAN disk can be added.

Figure 7-2 Add IP SAN Disk

Step 9 After having successfully added the IP SAN disk, return to the HDD Information menu. The added NetHDD will be displayed in the list.

If the installed HDD or NetHDD is uninitialized, select it and click **Init** for initialization.

7.1.3 Configure eSATA for Data Storage

When there is an external eSATA device connected to the device, you can configure eSATA for the data storage, and you can manage the eSATA in the device.

Step 1 Click **Storage>Advanced**.

Step 2 Select the eSATA type to Export or Record/Capture from **eSATA**.

Export: Use the eSATA for backup.

Record/Capture: Use the eSATA for record/capture. Refer to the following steps for operating instructions.

Figure 7-3 Set eSATA Mode

Step 3 When the eSATA type is set to Record/Capture, enter the storage device interface.

Step 4 Edit the property of the selected eSATA, or initialize it as required.

7.2 Storage Mode

7.2.1 Configure HDD Groups

Purpose

Multiple HDDs can be managed in groups. Video from specified channels can be recorded onto a particular HDD group through HDD settings.

Step 1 Go to **Storage> Storage Device**.

Step 2 Check the checkbox to select the HDD to set the group.

+ Add		Init		Total Capacity 1863.03GB		Free Space 1702.00GB			
<input type="checkbox"/>	Label	Capacity	Status	Property	Type	Free Space	Group	Edit	Delete
<input checked="" type="checkbox"/>	5	931.52GB	Normal	R/W	Local	871.00GB	2		
<input checked="" type="checkbox"/>	7	931.52GB	Normal	R/W	Local	831.00GB	1		

Figure 7-4 Storage Device

Step 3 Click  to enter the Local HDD Settings interface.

Local HDD Settings

HDD No. 5

HDD Property R/W Read-only Redundan...

Group 1 2 3 4 5 6 7 8

9 10 11 12 13 14 15 16

HDD Capacity 931.52GB

Figure 7-5 Local HDD Settings

Step 4 Select the Group number for the current HDD.

Step 5 Click **OK**.



Regroup the cameras for HDD if the HDD group number is changed.

Step 6 Go to **Storage> Storage Mode**.

Step 7 Check **Group** tab.

Step 8 Select the group No. from the list.

Step 9 Check the checkbox to select the IP camera(s) to record/capture on the HDD group.

Mode Quota Group

Record on HDD Group

<input type="checkbox"/> IP Camera	<input checked="" type="checkbox"/> D1	<input type="checkbox"/> D2	<input checked="" type="checkbox"/> D3	<input checked="" type="checkbox"/> D4	<input checked="" type="checkbox"/> D5	<input checked="" type="checkbox"/> D6	<input checked="" type="checkbox"/> D7	<input checked="" type="checkbox"/> D8
	<input type="checkbox"/> D9	<input type="checkbox"/> D10	<input checked="" type="checkbox"/> D11	<input checked="" type="checkbox"/> D12	<input type="checkbox"/> D13	<input type="checkbox"/> D14	<input type="checkbox"/> D15	<input type="checkbox"/> D16
	<input type="checkbox"/> D17	<input type="checkbox"/> D18	<input type="checkbox"/> D19	<input type="checkbox"/> D20	<input type="checkbox"/> D21	<input type="checkbox"/> D22	<input type="checkbox"/> D23	<input type="checkbox"/> D24
	<input type="checkbox"/> D25	<input type="checkbox"/> D26	<input type="checkbox"/> D27	<input type="checkbox"/> D28	<input type="checkbox"/> D29	<input type="checkbox"/> D30	<input type="checkbox"/> D31	<input type="checkbox"/> D32
	<input type="checkbox"/> D33	<input type="checkbox"/> D34	<input type="checkbox"/> D35	<input type="checkbox"/> D36	<input type="checkbox"/> D37	<input type="checkbox"/> D38	<input type="checkbox"/> D39	<input type="checkbox"/> D40
	<input type="checkbox"/> D41	<input type="checkbox"/> D42	<input type="checkbox"/> D43	<input type="checkbox"/> D44	<input type="checkbox"/> D45	<input type="checkbox"/> D46	<input type="checkbox"/> D47	<input type="checkbox"/> D48
	<input type="checkbox"/> D49	<input type="checkbox"/> D50	<input type="checkbox"/> D51	<input type="checkbox"/> D52	<input type="checkbox"/> D53	<input type="checkbox"/> D54	<input type="checkbox"/> D55	<input type="checkbox"/> D56

Apply

Figure 7-6 Storage Mode-HDD Group

Step 10 Click **Apply**.



Reboot the device to activate the new storage mode settings.

7.2.2 Configure HDD Quota

Purpose

Each camera can be configured with an allocated quota for storing recorded files or captured pictures.

Step 1 Go to **Storage> Storage Mode**.

Step 2 Check the checkbox of **Quota** tab.

Step 3 Select a camera to set quota.

Step 4 Enter the storage capacity in the text fields of **Max. Record Capacity (GB)** and **Max. Picture Capacity (GB)**.

Mode Quota Group

Camera [D1] IPCamera 01

Used Record Capacity 18.00GB

Used Picture Capacity 2048.00MB

HDD Capacity (GB) 1863

Max. Record Capacity (GB) 1500

Max. Picture Capacity (GB) 50

⚠ Free Quota Space 313 GB

Copy to Apply

Figure 7-7 Storage Mode-HDD Quota

Step 5 (Optional) You can click **Copy to** if you want to copy the quota settings of the current camera to other cameras.

Step 6 Click **Apply**.

 **NOTE**

When the quota capacity is set to 0, all cameras will use the total capacity of HDD for record and picture capture.

 **NOTE**

Reboot the device to activate the new storage mode settings.

7.3 Recording Parameters

7.3.1 Main Stream

The Main Stream refers to the primary stream that affects data recorded to the hard disk drive and will directly determine your recording quality and image size.

Comparing with the sub-stream, the main stream can provide a higher quality video with higher resolution and frame rate.

Frame Rate (FPS - Frames Per Second): refers to how many frames are captured each second. A higher frame rate is advantageous when there is movement in the video stream, as it maintains image quality throughout.

Resolution: Image resolution is a measure of how much detail a digital image can hold: the greater the resolution, the greater the level of detail. Resolution can be specified as the number of pixel-columns (width) by the number of pixel-rows (height), e.g., 1024×768.

Bitrate: The bit rate (in kbit/s or Mbit/s) is often referred to as speed, but actually defines the number of bits/time unit and not distance/time unit.

Enable H.264+ Mode: The H.264+ mode helps to ensure the high video quality with a lowered bitrate. It can effectively reduce the need of bandwidth and HDD storage space.

 **NOTE**

A higher resolution, frame rate and bitrate setting will provide you the better video quality, but it will also require more internet bandwidth and use more storage space on the hard disk drive.

7.3.2 Sub-Stream

The Sub-stream is a second codec that runs alongside the mainstream. It allows you to reduce the outgoing internet bandwidth without sacrificing your direct recording quality.

The Sub-stream is often exclusively used by smartphone applications to view live video. Users with limited internet speeds may benefit most from this setting.

7.3.3 Picture

The picture refers to the live picture capture in continuous or event recording type. (**Storage > Capture Schedule > Advanced**)

Picture Quality: set the picture quality to low, medium or high. The higher picture quality results in more storage space requirement.

Interval: the interval of capturing live picture.

Capture Delay Time: the duration of capturing pictures.

7.3.4 ANR

ANR (Automatic Network Replenishment) function which enables the IP camera to save the recording files in the local storage when the network is disconnected, and when the network is resumed, it uploads the files to the device.

Enable the ANR (Automatic Network Replenishment) function via the web browser (**Configuration > Storage > Schedule Settings > Advanced**).

7.3.5 Configure Advanced Recording Settings

Step 1 Go to **Storage > Schedule Settings > Record Schedule/Capture Schedule**.

Step 2 Check **Enable** to enable scheduled recording.

Step 3 Click **Advanced** to set the recording parameters.

The screenshot shows a dialog box titled "Advanced Parameters" with the following settings:

- Record Audio:
- Pre-Record: 5s
- Post-Record: 5s
- Stream Type: Main Stream
- Expired Time (day): 5
- Redundant Record/Capture

Buttons: OK, Cancel

Figure 7-8 Advanced Record Settings

Record Audio: Check the checkbox to enable or disable audio recording.

Pre-record: The time you set to record before the scheduled time or event. For example, when an alarm triggers the recording at 10:00, and if you set the pre-record time as 5 seconds, the camera records at 9:59:55.

Post-record: The time you set to record after the event or the scheduled time. For example, when an alarm triggered recording ends at 11:00, and if you set the post-record time as 5 seconds, it records till 11:00:05.

Expired Time: The expired time is period for a recorded file to be kept in the HDD. When the deadline is reached, the file will be deleted. If you set the expired time to 0, the file will not be deleted. The actual keeping time for the file should be determined by the capacity of the HDD.

Redundant Record/Capture: By enabling redundant record or capture you save the record and captured picture in the redundant HDD. See *Chapter Configure Redundant Recording and Capture*.

Stream Type: Main stream and sub-stream are selectable for recording. When you select sub-stream, you can record for a longer time with the same storage space.

Step 4 Click **OK** to save the settings.

7.4 Configure Recording Schedule

Set the record schedule, and then the camera automatically starts/stops recording according to the configured schedule.

Before you start

Make sure you have installed the HDDs to the device or added the network disks before you want to store the video files, pictures and log files.

Refer to the *Quick Start Guide* for the HDD installation.

Refer to *Chapter 7.1.2 Add the Network Disk* for network HDD connections.

Step 1 Go to **Storage > Recording Schedule**.

Step 2 Select a camera.

Step 3 Check the **Enable Schedule**.

Step 4 Select a **Record Type**. The record type can be Continuous, Motion Detection, Alarm, Motion | Alarm, Motion & Alarm, and Event.

Different recording types are configurable.

Continuous: scheduled recording.

Event: recording triggered by all event triggered alarm.

Motion: recording triggered by motion detection.

Alarm: recording triggered by alarm.

M/A: recording triggered by either motion detection or alarm.

M&A: recording triggered by motion detection and alarm.

POS: recording triggered by POS and alarm.

Step 5 Select a day and click-and-drag the mouse on the time bar to set the record schedule.

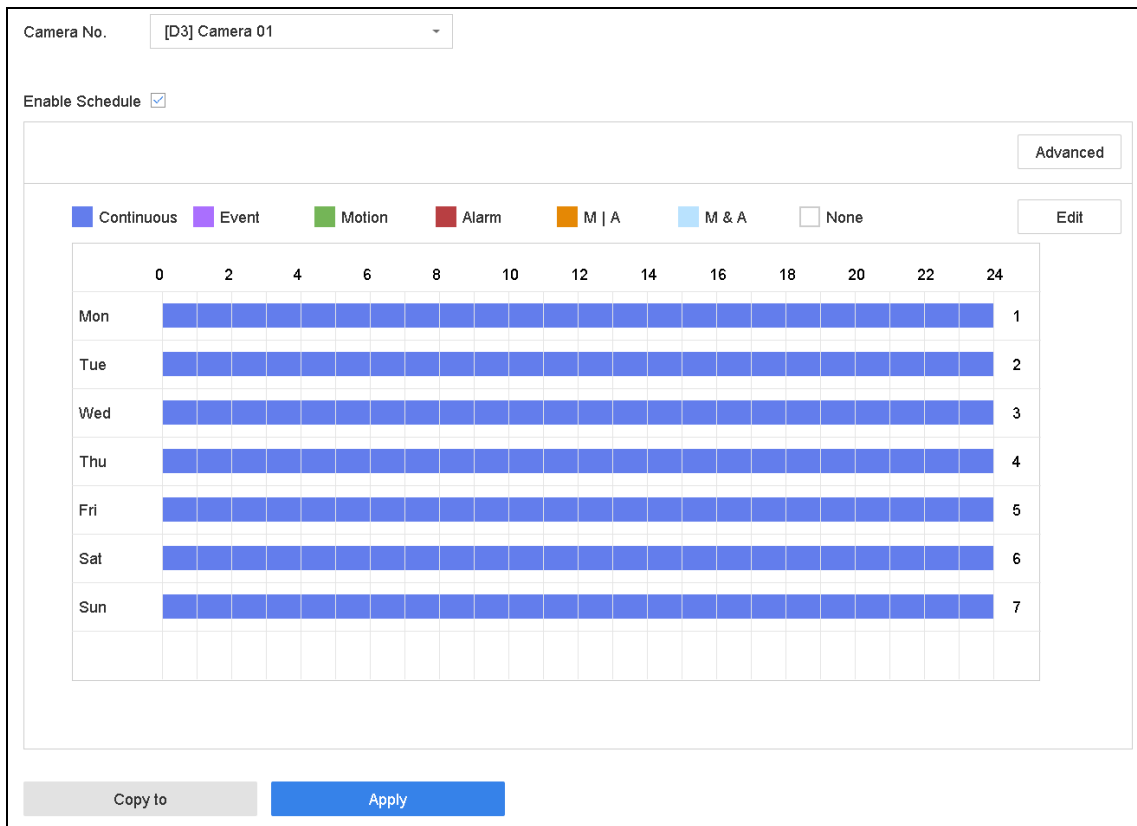



Figure 7-9 Record Schedule

Step 6 Repeat the above steps to schedule recording or capture for other days in the week.

 **NOTE**

The all-day continuous recording is configured for the device by factory default.

Step 7 (Optional) Copy the schedule settings of the one day to the other days of the week or holiday.

- 1) Click the  tab.
- 2) Select the day (s) to duplicate with the same schedule settings.
- 3) Click **OK**.

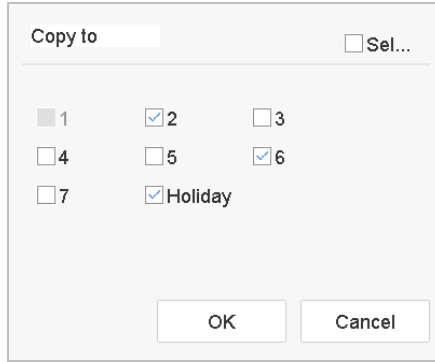

Figure 7-10 Copy Schedule to Other Days

Step 8 Click **Apply**.

i NOTE

To enable Motion, Alarm, M | A (motion or alarm), M & A (motion and alarm) and Event triggered recording and capture, you must configure the motion detection settings, alarm input settings and other events as well. Please refer to Chapter 11 Event and Alarm Settings and Chapter 12 VCA Event Alarm for details for details.

7.5 Configure Continuous Recording

Step 1 Go to **Camera > Encoding Parameters > Recording Parameters**.

Step 2 Set the continuous main stream/sub-stream recording parameters for the camera.

Step 3 Go to **Storage > Recording Schedule**.

Step 4 Select the recording type to **Continuous**.

Step 5 Drag the mouse on the time bar to set the continuous recording schedule. Refer to Chapter 7.4 Configure Recording Schedule for details.

7.6 Configure Motion Detection Triggered Recording

You can configure the recording triggered by the motion detection event.

Step 1 Go to **System > Event > Normal Event > Motion Detection**.

Step 2 Configure the motion detection and select the channel (s) to trigger the recording when motion event occurs. Refer to Chapter 11.3 Configure Motion Detection Alarm for details.

Step 3 Go to **Camera > Encoding Parameters > Recording Parameters**.

Step 4 Set the event main stream/sub-stream recording parameters for the camera.

Step 5 Go to **Storage > Recording Schedule**.

Step 6 Select the recording type to **Motion**.

Step 7 Drag the mouse on the time bar to set the motion detection recording schedule. Refer to Chapter 7.4 Configure Recording Schedule for details.

7.7 Configure Event Triggered Recording

You can configure the recording triggered by the motion detection, motion detection and alarm, face detection, vehicle detection, line crossing detection, etc.

Step 1 Go to **System > Event**.

Step 2 Configure the event detection and select the channel (s) to trigger the recording when event occurs. Refer to Chapter 11 Event and Alarm Settings and Chapter 12 VCA Event Alarm for details.

Step 3 Go to **Camera > Encoding Parameters > Recording Parameters**.

Step 4 Set the event main stream/sub-stream recording parameters for the camera.

Step 5 Go to **Storage > Recording Schedule**.

Step 6 Select the recording type to **Event**.

Step 7 Drag the mouse on the time bar to set the event detection recording schedule. Refer to Chapter 7.4 Configure Recording Schedule for details.

7.8 Configure Alarm Triggered Recording

You can configure the recording triggered by the motion detection, face detection, vehicle detection, line crossing detection, etc.

Step 1 Go to **System > Event > Normal Event > Alarm Input**.

Step 2 Configure the alarm input and select the channel (s) to trigger the recording when alarm occurs.

Refer to Chapter 11 Event and Alarm Settings and Chapter 12 VCA Event Alarm for details for details.

Step 3 Go to **Camera > Encoding Parameters > Recording Parameters**.

Step 4 Set the event main stream/sub-stream recording parameters for the camera.

Step 5 Go to **Storage > Recording Schedule**.

Step 6 Select the recording type to **Alarm**

Step 7 Drag the mouse on the time bar to set the alarm recording schedule. Refer to Chapter 7.4 Configure Recording Schedule for details.

7.9 Configure POS Event Triggered Recording

You can configure the recording triggered by the connected POS event, such as the transaction, etc.

Step 1 Go to **System > POS Settings**.

Step 2 Configure the POS and select the channel (s) in the **Event Linkage** to trigger the recording when POS event occurs.

Refer to Chapter 13 Smart Analysis for details.

Step 3 Go to **Camera > Encoding Parameters > Recording Parameters**.

Step 4 Set the event main stream/sub-stream recording parameters for the camera.

Step 5 Go to **Storage > Recording Schedule**.

Step 6 Select the record type to **POS Event**.

Step 7 Set the schedule for the POS event triggered recording. Refer to Chapter 7.4 Configure Recording Schedule for details.

7.10 Configure Picture Capture

The picture refers to the live picture capture in continuous or event recording type.

Step 1 Go to **Storage > Capture Schedule > Advanced**.

Step 2 Set the picture parameters.

- **Resolution:** set the resolution of the picture to capture.
- **Picture Quality:** set the picture quality to low, medium or high. The higher picture quality results in more storage space requirement.
- **Interval:** the interval of capturing live picture.
- **Capture Delay Time:** the duration of capturing pictures.

Step 3 Go to **Storage > Capture Schedule**.

Step 4 Select the camera to configure the picture capture.

Step 5 Set the picture capture schedule. Refer to Chapter 7.4 Configure Recording Schedule for details.

7.11 Configure Holiday Recording and Capture

Purpose:

Follow the steps to configure the record or capture schedule on holiday for that year. You may want to have different plan for recording and capture on holiday.

Step 1 Go to **System > Holiday Settings**.

Step 2 Select a holiday item from the list and click .

Step 3 Check the **Enable** to configure the holiday.

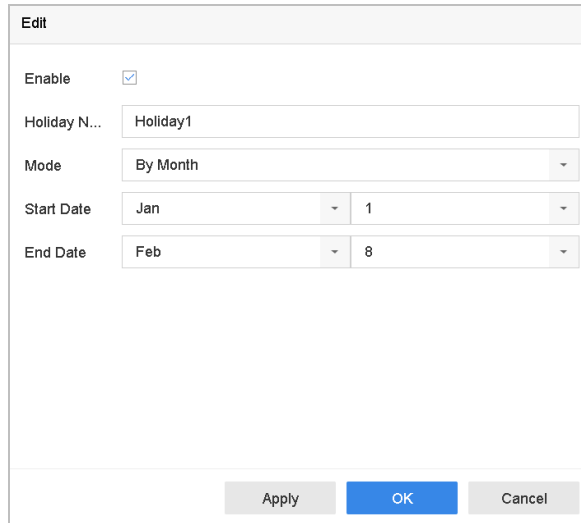

Edit	
Enable	<input checked="" type="checkbox"/>
Holiday N...	<input type="text" value="Holiday1"/>
Mode	<input type="text" value="By Month"/>
Start Date	<input type="text" value="Jan"/> <input type="text" value="1"/>
End Date	<input type="text" value="Feb"/> <input type="text" value="8"/>
<input type="button" value="Apply"/> <input type="button" value="OK"/> <input type="button" value="Cancel"/>	

Figure 7-11 Edit Holiday Settings

- 1) Edit the holiday name.
- 2) Select the mode to by date, by week or by month.
- 3) Set the start and end date of the holiday.
- 4) Click **OK**.

Step 4 Set the schedule for the holiday recording. Refer to Chapter 7.4 Configure Recording Schedule for details.

7.12 Configure Redundant Recording and Capture

Purpose:

Enabling redundant recording and capture, which means saving the record files and captured pictures not only in the R/W HDD but also in the redundant HDD, will effectively enhance the data safety and reliability. .



You must set the storage mode to *Group* before you set the HDD property to Redundancy. For detailed information, please refer to Chapter 7.2.1 Configure HDD Group. There should be at least another HDD which is in Read/Write status.

Step 1 Go to **Storage > Storage Device**.

Step 2 Select a **HDD** from the list and Click  to enter the Local HDD Settings interface.

Step 3 Set the HDD property to **Redundancy**.

Figure 7-12 HDD Property-Redundancy

Step 4 Go to **Storage > Schedule Settings > Record Schedule/Capture Schedule**.

Step 5 Click **Advanced** to set the camera recording parameters.

The image shows a dialog box titled "Advanced Parameters" with the following settings:

- Record Audio:
- Pre-Record: 5s (dropdown menu)
- Post-Record: 5s (dropdown menu)
- Stream Type: Main Stream (dropdown menu)
- Expired Time (day): 5 (text input)
- Redundant Record/Capture

At the bottom of the dialog are two buttons: "OK" (blue) and "Cancel" (grey).

Figure 7-13 Record Parameters

Step 6 Check the checkbox of **Redundant Record/Capture**.

Step 7 Click **OK** to save settings.

Chapter 8 Disk Array (RAID)

Purpose

A disk array is a data storage virtualization technology that combines multiple physical disk drives into a single logical unit. Also known as a “RAID”, an array stores data over multiple HDDs to provide enough redundancy so that data can be recovered if one disk fails. Data is distributed across the drives in one of several ways called "RAID levels", based the redundancy and performance required.



Disk arrays are supported by DS-9600NI-I Series device only.

8.1 Create a Disk Array

Purpose

The device supports software-based disk arrays. Enable the RAID function as required. Two ways are available for creating an array: one-touch configuration and manual configuration. The following flow chart shows the process of creating array.

8.1.1 Enable a RAID

Purpose

Perform the following steps to enable the disk array function.

Step 1 Go to **Storage > Advanced**.

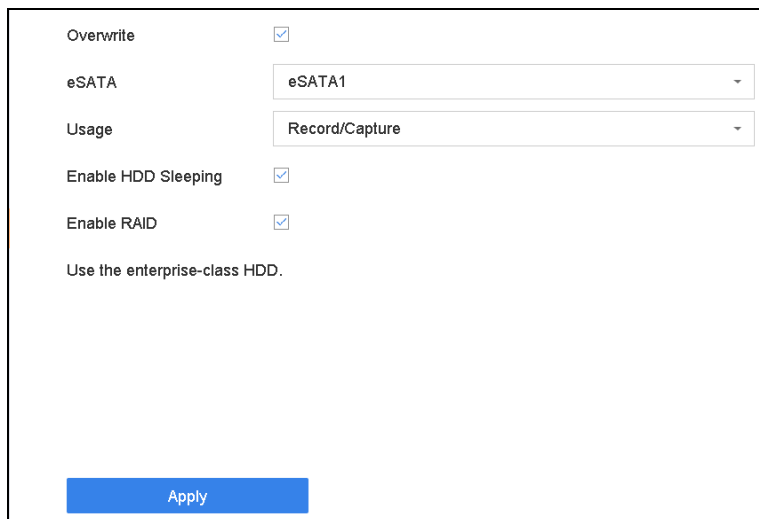

Figure 8-1 Advanced

Step 2 Check **Enable RAID**.

Step 3 Click **Apply**.

Step 4 Reboot the device to have settings take effect.

8.1.2 One-Touch Creation

Purpose

One-touch configuration creates the disk array. By default, the array type created by one-touch configuration is RAID 5.

Before You Start

- Enable the RAID function. For details, refer to Chapter 8.1.1 Enable a RAID.
- Install at least 3 HDDs. If more than 10 HDDs are installed, 2 arrays will be created. To maintain reliability and stability running of the HDDs, it is recommended to use of enterprise-level HDDs of the same model and capacity.

Step 1 Go to **Storage > RAID Setup > Physical Disk**.

No.	Capacity	Array	Type	Status	Model	Hot Spare	Task
1	1863.02GB		Normal	Functional	ST2000VX000-1CU164	<input checked="" type="checkbox"/>	None
2	2794.52GB		Normal	Functional	ST3000VX000-9YW166	<input checked="" type="checkbox"/>	None
5	1863.02GB		Normal	Functional	ST2000VX000-1CU164	<input checked="" type="checkbox"/>	None
9	2794.52GB		Normal	Functional	ST3000VX000-1CU166	<input checked="" type="checkbox"/>	None
10	1863.02GB		Normal	Functional	ST2000VX000-1CU164	<input checked="" type="checkbox"/>	None

Figure 8-2 Physical Disk

Step 2 Click **One-touch Config**.

Step 3 Edit the array name in **Array Name** and click **OK** to start configuring.



NOTE

If you install 4 or more HDDs, a hot spare disk for array rebuilding will be created.

Step 4 When a message box pops up when the array creation is completed, click **OK** on it.

Step 5 Optionally, the device will automatically initialize the created array. Go to **Storage > RAID Setup > Array** to view the information of the created array.

8.1.3 Manual Creation

Purpose

Manually create a RAID 0, RAID 1, RAID 5, RAID 6, or RAID 10 array.

Step 1 Go to **Storage > RAID Setup > Physical Disk**.

Step 2 Click **Create**.

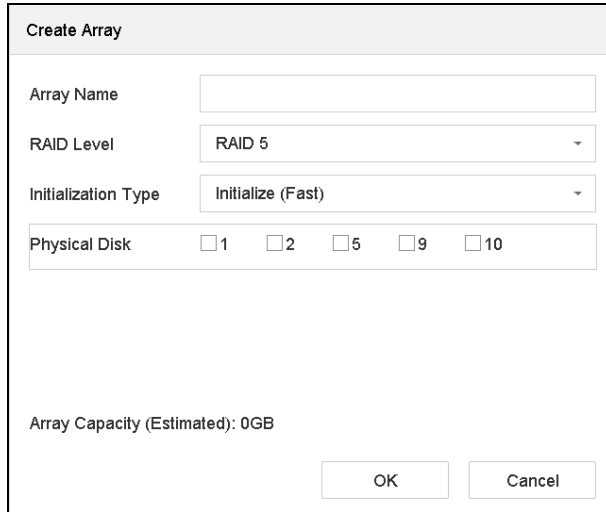

Table 8-1 Create Array Window

Step 3 Input the array name.

Step 4 Select **RAID Level** as **RAID 0**, **RAID 1**, **RAID 5**, **RAID 6**, or **RAID 10** as required.

Step 5 Select the physical disks to constitute the array.

Table 8-2 Required Number of HDDs

RAID Level	Required Number of HDDs
RAID 0	At least 2 HDDs.
RAID 1	At least 2 HDDs.
RAID 5	At least 3 HDDs.
RAID 6	At least 4 HDDs.
RAID 10	The number of HDD must be an even ranges from 4 to 16.

Step 6 Click **OK**.

Step 7 Optionally, the device will automatically initialize the created array. Go to **Storage > RAID Setup > Array** to view the information of the created array.

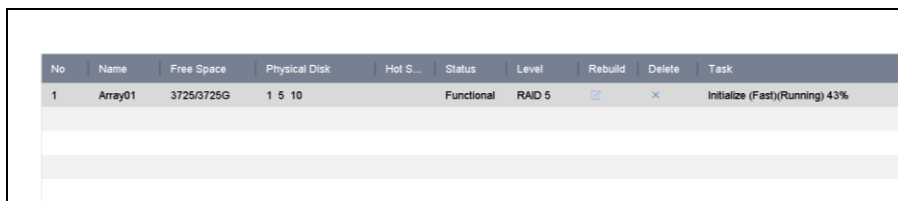

Figure 8-3 Array List

8.2 Rebuild an Array

Purpose:

The array status includes Functional, Degraded, and Offline. To ensure the high security and reliability of the data stored in an array, take immediate and proper maintenance of the arrays according its status.

- Functional: No disk loss in the array.
- Offline: The number of lost disks has exceeded the limit.
- Degraded: If any HDD fails in the array, the array degrades. Restore it to Functional status by rebuilding the array.

8.2.1 Configure a Hot Spare Disk

Purpose

Hot spare disks are required for disk array automatic rebuilding.

Step 1 Go to **Storage > RAID Setup > Physical Disk**.

No.	Capacity	Array	Type	Status	Model	Hot Spare	Task
1	1863.02GB	Array01	Array	Functional	ST2000VX000-1CU164	—	None
<input type="checkbox"/> 2	2794.52GB		Normal	Functional	ST3000VX000-9YW166	<input checked="" type="checkbox"/>	None
5	1863.02GB	Array01	Array	Functional	ST2000VX000-1CU164	—	None
<input type="checkbox"/> 9	2794.52GB		Normal	Functional	ST3000VX000-1CU166	<input checked="" type="checkbox"/>	None
10	1863.02GB	Array01	Array	Functional	ST2000VX000-1CU164	—	None

Figure 8-4 Physical Disk

Step 2 Click  of an available HDD to set it as the hot spare disk.

8.2.2 Automatically Rebuild an Array

Purpose

The device can automatically rebuild degraded arrays with the hot spare disks.

Before You Start

Create hot spare disks. For details, refer to Chapter 8.2.1 Configure a Hot Spare Disk.

Step 1 The device will automatically rebuild degraded arrays with the hot spare disks. Go to **Storage > RAID Setup > Array** to view rebuilding progress.



No	Name	Free Space	Physical Disk	Hot Spare	Status	Level	Rebuild	Delete	Task
1	Array01	3725/3725G	2 5 10		Degraded	RAID 5			Rebuild(Running) 0%

Figure 8-5 Array List

8.2.3 Manually Rebuild an Array

Purpose

If no hot spare disks are configured, rebuild a degraded array manually.

Before You Start

At least one available physical disk must exist to rebuild an array.

Step 1 Go to **Storage > RAID Setup > Array**.



No.	Name	Free Space	Physical Disk	Hot Spare	Status	Level	Rebuild	Delete	Task
1	Array01	3725/3725G	2 5 10		Degraded	RAID 5			Rebuild(Running) 0%

Figure 8-6 Array List

Step 2 Click  of the degraded array.

Rebuild Array

Array Name

RAID Level

Array Disk

Physical Disk 2 9

Figure 8-7 Rebuild Array

Step 3 Select the available physical disk.

Step 4 Click **OK**.

Step 5 Click **OK** on the pop up message box “Do not unplug the physical disk when it is under rebuilding.”

8.3 Delete an Array



Deleting an array will delete all the data saved to it.

Step 1 Go to **Storage > RAID Setup > Array.**

No.	Name	Free Space	Physical Disk	Hot Spare	Status	Level	Rebuild	Delete	Task
1	Array01	3725/3725G	5 10		Degraded	RAID 5			None

Figure 8-8 Array List

Step 2 Click of the array to delete it.

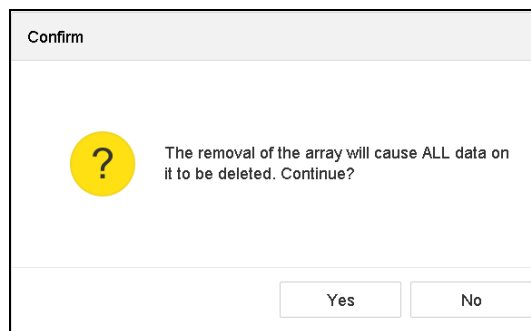

Figure 8-9 Attention

Step 3 Click **Yes** on the popup message box.

8.4 Check and Edit Firmware

Purpose

You can view the firmware information and set the background task speed on the Firmware interface.

Step 1 Go to **Storage > RAID Setup > Firmware**.

Version	1.1.0.0003
Physical Disk Count	16
Array Count	16
Virtual Disk Count	0
RAID Level	0 1 5 6 10
Hot Spare Type	Global Hot Spare
Support Rebuild	Yes
Background Task Speed	Medium Speed

Figure 8-10 Firmware

Step 2 Optionally, set the **Background Task Speed**.

Step 3 Click **Apply**.

Chapter 9 File Management

9.1 Search and Export All Files

9.1.1 Search Files

Purpose

Specify detailed conditions to search videos and pictures.

Step 1 Go to **File Management > All Files**.

Step 2 Specify detailed conditions, including time, camera, event type, etc.

The screenshot shows a search filter interface with the following elements:

- Time:** A dropdown menu set to "Today" and two date-time pickers showing "2017-10-24 00:00:00" and "2017-10-24 23:59:59".
- Camera:** A dropdown menu set to "[All] Camera".
- Tag:** An empty text input field.
- File Status:** A dropdown menu set to "All".
- Event Type:** A dropdown menu set to "None".
- Plate No.:** An empty text input field.
- Area/Country:** A dropdown menu set to "None".
- Buttons:** Three buttons at the bottom: "Empty Conditions", "Search", and "Save".

Figure 9-1 Search All Files

Step 3 Click **Search** to display results. The matched files will be displayed.

9.1.2 Export Files

Purpose

Export files for backup purposes using a USB device (USB flash drive, USB HDD, USB optical disc drive), SATA optical disc drive, or eSATA HDD.

Step 1 Search files to export. For details, see *9.1.1 Search Files*.

Step 2 Click files to select and click **Export**.

Step 3 Select the file to export as **Video and Log** and click **OK**.

Step 4 Click **OK** to export files to backup device.

9.2 Search and Export Human Files

9.2.1 Search Human Files

Purpose

Specify detailed conditions by which to search human pictures and videos.

Before You Start

Configure the human body detection function for the cameras you want to search and export human pictures and videos.

Step 1 Go to **File Management > Human Files**.

Step 2 Select **Time** and **Camera** to search.

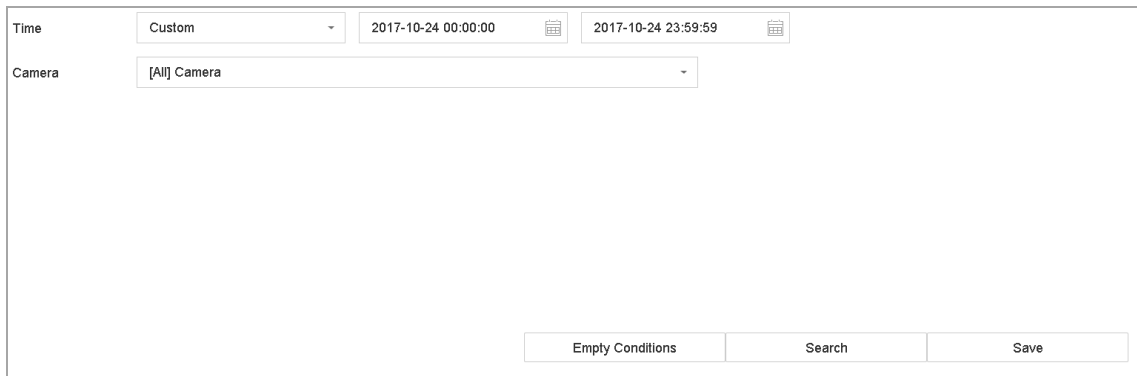

Figure 9-2 Search Human Files

Step 3 Click **Search** to display results. The matched files are displayed in thumbnails or a list.

Step 4 Select **Target Picture** or **Source Picture** in the menu bar to display related pictures only.

- **Target Picture:** Display the search results of people close-ups.
- **Source Picture:** Display the search results of original pictures captured by the camera.

9.2.2 Export Human Files

Purpose

Export files for backup purposes using a USB device (USB flash drive, USB HDD, USB optical disc drive), SATA optical disc drive, or eSATA HDD.

Step 1 Search for the human files to export. For details, see *9.2.1 Search Human Files*.

Step 2 Click to select files and click **Export**.

Step 3 Select the file to export as **Video and Log** and click **OK**.

Step 4 Click **OK** to export files to backup device.

9.3 Search and Export Vehicle Files

9.3.1 Search Vehicle Files

Purpose

Specify detailed conditions by which to search vehicle pictures and videos.

Before You Start

Configure the vehicle detection function for the cameras you want to search and export vehicle pictures and videos.

Step 1 Go to **File Management > Vehicle Files**.

Step 2 Specify detailed conditions, including **Time**, **Camera**, **Plate No.**, and **Area/Country**.

The screenshot shows a search configuration form with the following elements:

- Time:** A dropdown menu set to "Custom", followed by two date-time pickers showing "2017-10-24 00:00:00" and "2017-10-24 23:59:59".
- Camera:** A dropdown menu set to "[All] Camera".
- Plate No.:** An empty text input field.
- Area/Country:** A dropdown menu set to "None".
- Buttons:** Three buttons at the bottom: "Empty Conditions", "Search", and "Save".

Figure 9-3 Search Vehicle Files

Step 3 Click **Search** to display results. The matched files are displayed in thumbnails or a list.

Step 4 Select **Target Picture** or **Source Picture** in the menu bar to display related pictures only. Select **Video** or **Picture** to specify the file type.

- **Target Picture:** Display the search results of vehicle close-ups.
- **Source Picture:** Display the search results of original pictures captured by the camera.

9.3.2 Export Vehicle Files

Purpose

Export files for backup purposes to a USB device (USB flash drive, USB HDD, USB optical disc drive), SATA optical disc drive, or eSATA HDD.

Step 1 Search for the vehicle files to export. For details, see *9.3.1 Search Vehicle Files*.

Step 2 Click files to select and click **Export**.

Step 3 Select the file to export as **Video and Log** and click **OK**.

Step 4 Click **OK** to export files to backup device.

9.4 Search History Operation

9.4.1 Save Search Conditions

Purpose

You can save the search conditions for future reference and quick searches.

Step 1 Go to **File Management > All Files/People Appearance File/Vehicle File**.

Step 2 Set the search conditions.

Step 3 Click **Save**.

Step 4 Enter a name in text field and click **Finished**. The saved search conditions will be displayed in search history list.

9.4.2 Call Search History

Purpose

You can quickly search files by calling the search history.

Step 1 Go to **File Management > All Files/Human Files/Vehicle Files**.

Step 2 Click a search conditon to search files quickly.

Chapter 10 Playback

10.1 Play Video Files

10.1.1 Instant Playback

Instant Playback enables the device to play the recorded video files recorded in the last five minutes. If no video is found, it means there is no recording during the last five minutes.

Step 1 On the Live View window of the selected camera, move the cursor to the window bottom to access the toolbar.

Step 2 Click  to start instant playback.



Figure 10-1 Playback Interface

10.1.2 Play Normal Video

Step 1 Go to **Playback**.

Step 2 Check one or more cameras in the camera list to start playing the video.

Step 3 Select a date in the calendar to start playing the video.

Step 4 Use the toolbar in the bottom part of the playback interface to control the playing and perform a series of operations. Refer to Chapter 10.2 Playback Operations 8.2.

Step 5 Click the channel(s) to execute simultaneous playback of multiple channels.



Figure 10-2 Playback Interface

NOTE

256x playing speed is supported.

10.1.3 Play Smart Searched Video

In smart playback mode, the device can analyze the video containing the motion, line, or intrusion detection information, mark it in red, and play the smart searched video.

NOTE

The smart playback must be in the single-channel playing mode.

Step 1 Go to **Playback**.

Step 2 Start playing the video of camera.

Step 3 Click **Smart**.

Step 4 From the toolbar at the bottom of the playing window, click the motion/line crossing/ intrusion icon for search.



Figure 10-3 Playback by Smart Search

Step 5 Set the rules and areas for smart search of line crossing detection, intrusion detection or motion detection event triggered recording.



●Line Crossing Detection

- 1) Click the  icon.
- 2) Click on the image to specify the start point and end point of the line.

●Intrusion Detection

- 1) Click the  icon.
- 2) Specify 4 points to set a quadrilateral region for intrusion detection. Only one region can be set.

●Motion Detection

- 1) Click the  icon.
- 2) Hold the mouse on the image to draw the detection area manually.
- 3) Click Search  to search the matched video and start to play it.

10.1.4 Play Custom Searched Files

You can play the files by custom search with different conditions.

Step 1 Go to **Playback**.

Step 2 Select a camera or cameras from the list.

Step 3 Click **Custom Search** on the left bottom to enter the Search Condition interface.

Step 4 Enter the search conditions for the files, e.g., time, file status, event type, etc.

The screenshot shows a search criteria form with the following fields and values:

- Time: Custom, 2017-10-01 00:00:00, 2017-10-23 23:59:59
- Tag: A
- File Status: All
- Event Type: None
- Plate No.: (empty)
- Area/Country: None

Buttons at the bottom: Empty Conditions, Search, Save

Figure 10-4 Custom Search

Step 5 Click **Search**.

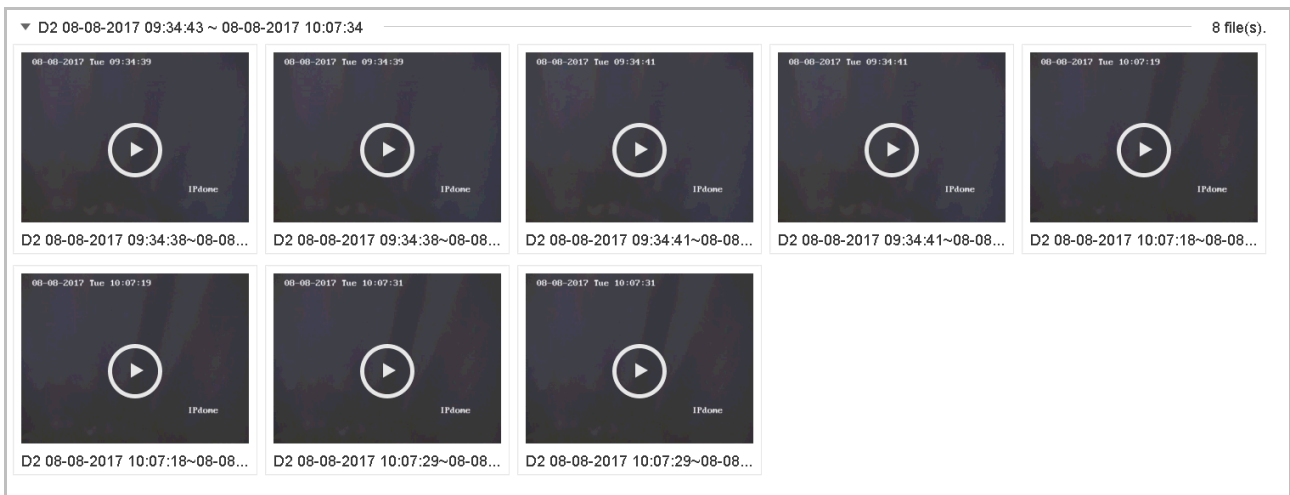

Figure 10-5 Custom Searched Video Files

Step 6 On the search results interface, select a file and click to start playing the video.

10.1.5 Play Tag Files

Purpose

Video tag allows you to record related information such as people and locations of a certain time point during playback. You can use video tag(s) to search for video files and position time point.

Before playing back by tag:

Add Tag Files

Step 1 Go to **Playback**.

Step 2 Search and play back the video file(s).

Step 3 Click  to add the tag.

Step 4 Edit the tag information.

Step 5 Click **OK**.

 **NOTE**

Max. 64 tags can be added to a single video file.

Edit Tag Files

You can edit the tag information for the existed tag video.

Step 1 Go to **Playback**.

Step 2 Click **Tag**.

The available tags are white marked and displayed in the time bar.

Step 3 Point the white marked tag in the time bar to access the tag information.

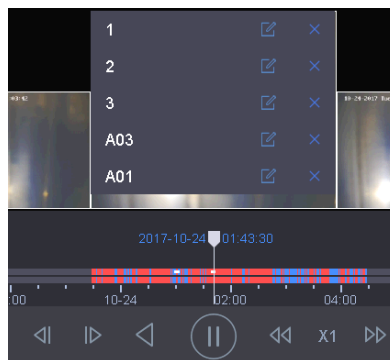



Figure 10-6 Edit Tag Files

Step 4 Click  to edit the tag name.

Step 5 Click **OK**.

Play Tag Files

Step 1 Go to **Playback**.

Step 2 Click **Custom Search** on the left bottom to enter the Search Condition interface.

Step 3 Enter the search conditions for the tag files, including the time and the tag keyword.

The screenshot shows a search interface with the following fields and values:

- Time: Custom, 2017-10-01 00:00:00, 2017-10-23 23:59:59
- Tag: A
- File Status: All
- Event Type: None
- Plate No.: (empty)
- Area/Country: None

Buttons at the bottom: Empty Conditions, Search, Save

Figure 10-7 Tag Search

Step 4 Click **Search**.

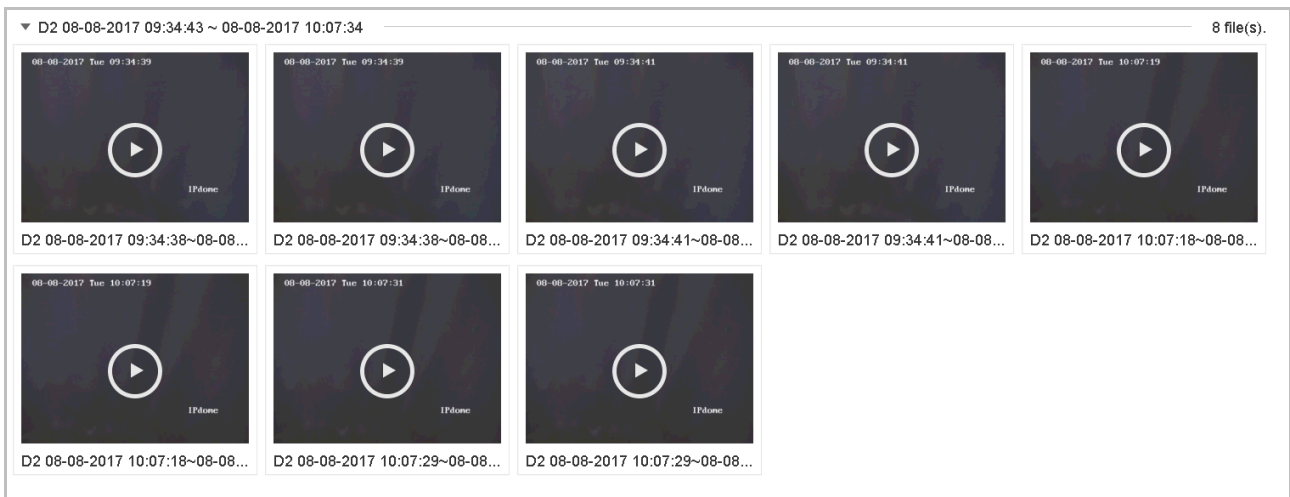

Figure 10-8 Searched Tag Files

Step 5 On the search results interface, select a tag file and click to start playing the video.

10.1.6 Play Event Files

Purpose

Play back video files on one or several channels searched by event type (e.g., alarm input, motion detection, line crossing detection, face detection, vehicle detection, etc.).

Step 1 Go to **Playback**.

Step 2 Click **Custom Search** on the left bottom to enter the Search Condition interface.

Step 3 Enter the search conditions for the event files, e.g., time, event type, file status, vehicle information (for vehicle detection event), etc.

Step 4 Click **Search**.

Step 5 On the search results interface, select an event video file/picture file and double click to start playing the video.

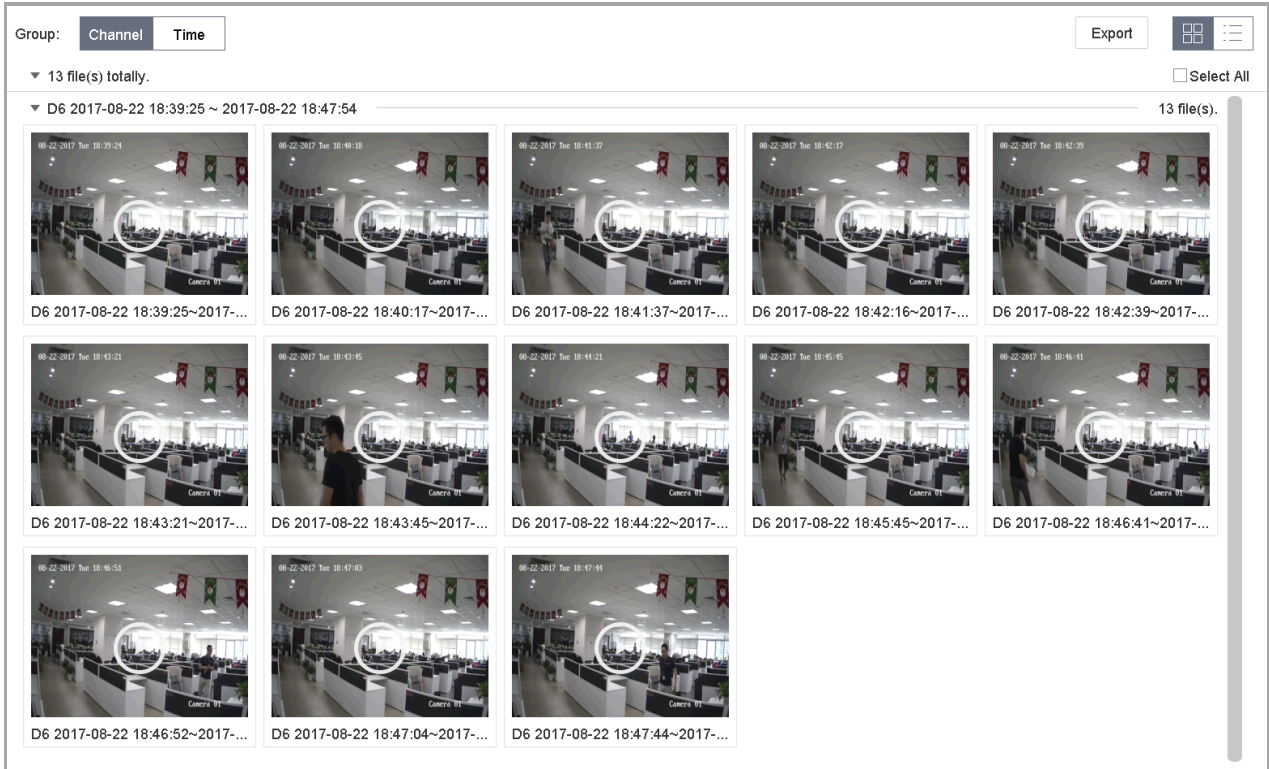



Figure 10-9 Event Files

You can click  or  button to play 30s backward or forward.

NOTE

- Refer to Chapter 11

Event and Alarm Settings and Chapter 12 VCA Event Alarm for details for event and alarm settings.

- Refer to Chapter 7.7 Configure Event Triggered Recording for the event triggered recording/capture settings.

10.1.7 Play Video Synopsis

Purpose:

Video synopsis is an approach to create a short video summary of a long video. It tracks and analyzes moving objects (also called events), and converts video streams into a database of objects and activities.

Before you start:

Enable Dual-VCA and intrusion detection/line crossing detection on the network camera.

Step 1 Go to **Playback** interface.

Step 2 Click  in toolbar.



Figure 10-10 Synopsis Playback

Step 3 Select a camera in channel list.

Step 4 Specify **Start Time** and **End Time**. The duration must be within 24 hours.

Step 5 Click **Search** to start play.

Step 6 Optionally, double click a target on the playback window. A 60-second video of 30 seconds before and after the time will be played.

10.1.8 Play by Sub-periods

Purpose:

The video files can be played in multiple sub-periods simultaneously on the screen.

Step 1 Go to **Playback**.

Step 2 Select  icon at the left bottom corner to enter the sub-period playing mode.

Step 3 Select a camera.

Step 4 Set the start time and end time for searching video.

Step 5 Select the different multi-period at the right bottom corner, e.g., 4-Period.



NOTE

According to the defined number of split-screens, the video files on the selected date can be divided into average segments for playback. E.g., if there are video files existing between 16:00 and 22:00, and the 6-screen display mode is selected, then it can play the video files for 1 hour on each screen simultaneously.

10.1.9 Play Log Files

Purpose

Play back record file(s) associated with channels after searching system logs.

Step 1 Go to **Maintenance>Log Information**.

Step 2 Click **Log Search**.

Step 3 Set search time and type and click **Search**.

No.	Major Type	Time	Minor Type	Parameter	Play	Details
5	Alarm	2017-10-25 00:04:30	Motion Detection Started	N/A	▶	ⓘ
6	Alarm	2017-10-25 00:04:42	Motion Detection Stopped	N/A	▶	ⓘ
7	Alarm	2017-10-25 00:06:04	Motion Detection Started	N/A	▶	ⓘ
8	Operation	2017-10-25 00:06:18	Local Operation: Playback By Time	N/A	–	ⓘ
9	Alarm	2017-10-25 00:06:19	Motion Detection Stopped	N/A	▶	ⓘ
10	Alarm	2017-10-25 00:06:41	Motion Detection Started	N/A	▶	ⓘ
11	Information	2017-10-25 00:06:46	System Running Status	N/A	–	ⓘ
12	Information	2017-10-25 00:06:46	System Running Status	N/A	–	ⓘ
13	Alarm	2017-10-25 00:07:02	Motion Detection Stopped	N/A	▶	ⓘ
14	Alarm	2017-10-25 00:07:59	Motion Detection Started	N/A	▶	ⓘ
15	Alarm	2017-10-25 00:08:15	Motion Detection Stopped	N/A	▶	ⓘ
16	Alarm	2017-10-25 00:08:27	Motion Detection Started	N/A	▶	ⓘ
17	Operation	2017-10-25 00:08:43	Local Operation: Playback By Time	N/A	–	ⓘ
18	Operation	2017-10-25 00:08:46	Local Operation: Playback By Time	N/A	–	ⓘ
19	Alarm	2017-10-25 00:08:57	Motion Detection Stopped	N/A	▶	ⓘ
20	Operation	2017-10-25 00:09:13	Local Operation: Playback By Time	N/A	–	ⓘ
21	Alarm	2017-10-25 00:09:22	Motion Detection Started	N/A	▶	ⓘ
22	Alarm	2017-10-25 00:09:35	Motion Detection Stopped	N/A	▶	ⓘ

Total: 157 P: 1/2

Figure 10-11 System Log Search Interface

Step 4 Choose a log with a video file and click  to start playing the log file.

10.1.10 Play External Files

Purpose

You can play files from external storage devices.

Before You Start

Connect the storage device with the video files to your device.

Step 1 Go to **Playback**.

Step 2 Click  at the left bottom corner.

Step 3 Select and click to  or double click to play the file.

10.2 Playback Operations

10.2.1 Set Play Strategy in Smart/Custom Mode

Purpose:

When you are in the smart or custom video playback mode, you can set the playing speed separately for the normal video and the smart/custom video, or you can select to skip the normal video.



In the Smart/Custom video playback mode, click  to set the play strategy.

- When **Do not Play Normal Videos** is checked, the device will skip the normal video and play the smart (motion/line crossing/intrusion) video and the custom (searched video) only in the normal speed (X1).
- When **Do not Play Normal Videos** is unchecked, you can set the play speed for the normal video the smart/custom video separately. The speed range is from X1 to XMAX.

 **NOTE**

You can set the speed in the single-channel play mode only.

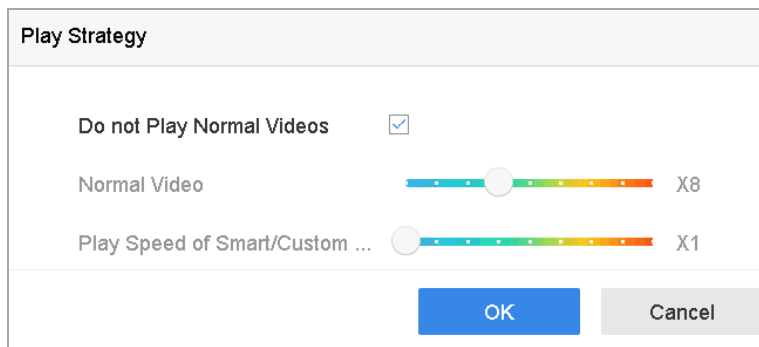



Figure 10-12 Play Strategy

10.2.2 Edit Video Clips

You can take video clips during playback and export the clips.



In the Video Playback mode, click  to start the video clipping operation.

- : Set the start time and end time of the video clipping.
- : Export the video clips to the local storage device.

10.2.3 Switch between Main Stream and Sub-Stream

You can switch between the main stream and the sub-stream during playback.



: Play the video in main stream.



: Play the video in sub-stream.

 **NOTE**

The encoding parameters for the main stream and sub-stream can be configured in **Storage > Encoding Parameters**.

10.2.4 Thumbnails View

With the thumbnails view on the playback interface, you can conveniently locate the required video files on the time bar.

In the playback mode, move the mouse to the time bar to get the preview thumbnails of the video files.

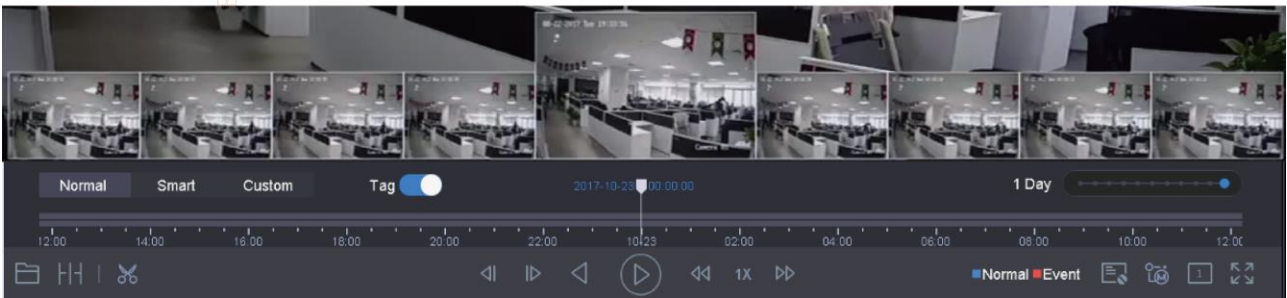







Figure 10-13 Thumbnails View

You can select and click on a thumbnail to enter the full-screen playback.

10.2.5 Fisheye View

You can enter the fisheye expansion view during the video playback.

Click the  to enter the fisheye expansion mode.

- **180° Panorama** (): Switch the live view image to the 180° panorama view.
- **360° Panorama** (): Switch the Live View image to the 360° panorama view.
- **PTZ Expansion** (): The PTZ Expansion is the close-up view of a defined area in the fisheye view or panorama expansion, and it supports the electronic PTZ function, which is also called e-PTZ.
- **Radial Expansion** (): In the radial expansion mode, the whole wide-angle view of the fisheye camera is displayed. This view mode is called Fisheye View because it approximates the vision of a fish's convex eye. The lens produces curvilinear images of a large area, while distorting the perspective and angles of objects in the image.

10.2.6 Fast View

Hold the mouse to drag on the time bar to get a fast view of the video files.

In the Video Playback mode, hold and drag the mouse through the playing time bar to fast view the video files.

Release the mouse at the required time point to enter the full-screen playback.

10.2.7 Digital Zoom

Digital zoom adopts encoding technology to enlarge the image which will result in image quality damage.

In the Video Playback mode, click  in the toolbar to enter the digital zoom interface.

Move the sliding bar or scroll the mouse wheel to zoom in/out of the image to different magnifications (1 to 16X).



Figure 10-14 Digital Zoom

10.2.8 POS Information Overlay

The device can be connected with the POS machine/server, and receive the transaction message for overlay on the image during playback.

In the video playback mode, click  to overlay the POS transaction information on the playback video.

NOTE

When the playing speed is higher than 2x, the POS information cannot be overlaid on the video.

Chapter 11 Event and Alarm Settings

11.1 Configure Arming Schedule

Step 1 Select the **Arming Schedule** tab.

Step 2 Choose a day of the week and set the time period. Up to eight time periods can be set each day.



Time periods cannot repeat or overlapped.

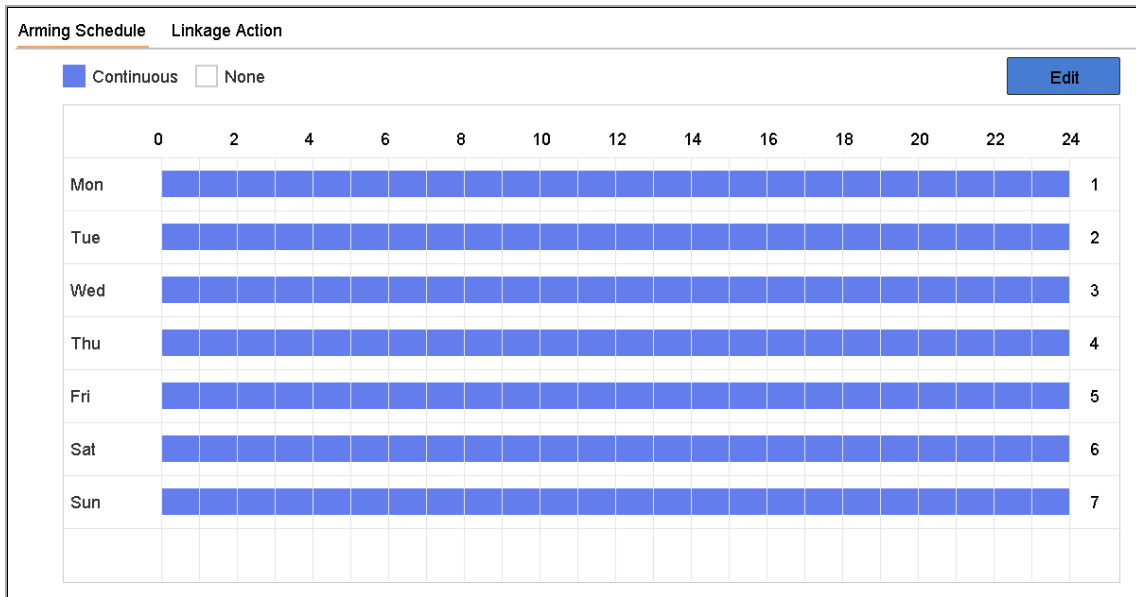

Figure 11-1 Set Arming Schedule

Step 3 (Optional) To copy the same arming schedule of the current day to the other day (s) of the week or holiday, you can click to copy the arming schedule settings.

Step 4 Click **Apply** to save the settings.

11.2 Configure Alarm Linkage Actions

Step 1 Click **Linkage Action** to set the alarm linkage actions.

Area	Arming Schedule	Linkage Action
<input checked="" type="checkbox"/> Normal Linkage	<input checked="" type="checkbox"/> Trigger Alarm Output	<input type="checkbox"/> Trigger Channel
<input checked="" type="checkbox"/> Full Screen Monitoring	<input checked="" type="checkbox"/> Local->1	<input type="checkbox"/> D1
<input checked="" type="checkbox"/> Audible Warning	<input checked="" type="checkbox"/> Local->2	<input checked="" type="checkbox"/> D2
<input checked="" type="checkbox"/> Notify Surveillance Center	<input checked="" type="checkbox"/> Local->3	
<input checked="" type="checkbox"/> Send Email	<input checked="" type="checkbox"/> Local->4	
	<input checked="" type="checkbox"/> 10.15.2.250:8000->1	

*Notice: please confirm the event output in "Live View" settings menu is the same with the real event output.

Apply

Figure 11-2 Set Linkage Actions

Step 2 Select the normal linkage actions, trigger alarm output, or trigger the recording channel.

- **Full Screen Monitoring**

When an alarm is triggered, the local monitor displays in full screen the video image from the alarming channel configured for full screen monitoring.

If alarms are triggered simultaneously in several channels, their full-screen images will be switched at an interval of 10 seconds (default dwell time). A different dwell time can be set by going to **System>Live View > Full Screen Monitoring Dwell Time**.

Auto-switch will terminate once the alarm stops and return to the Live View interface.

 **NOTE**

Select the channel(s) you want to trigger full screen monitoring in **Trigger Channel** settings.

- **Audible Warning**

It will trigger an audible *beep* when an alarm is detected.

- **Notify Surveillance Center**

It will send an exception or alarm signal to the remote alarm host when an event occurs. The alarm host refers to the PC installed with Remote Client.



NOTE

The alarm signal will be transmitted automatically at detection mode when a remote alarm host is configured. Refer to Chapter 15.8 Configure Ports for alarm host configuration.

- **Send Email**

It will send an e-mail with alarm information to the user when an alarm is detected.

Refer to 15.7 Configure Email for details of e-mail configuration details.

Step 3 Check the checkbox to select the alarm output when an alarm is triggered.



NOTE

To trigger an alarm output when an event occurs, please refer to Chapter 11.6.3 Configure Alarm Output to set the alarm output parameters.

Step 4 Click **Trigger Channel** and select one or more channels that will record/capture or perform full-screen monitoring when a motion alarm is triggered.



NOTE

You have to set the recording schedule to realize this function. Refer to Chapter 7.4 Configure Recording Schedule for setting the recording schedule.

Step 5 Click **Apply** to save the settings.

11.3 Configure Motion Detection Alarms

Motion Detection enables the device to detect the moving objects in the monitored area and trigger alarms.

Step 1 Go to **System> Event>Normal Event>Motion Detection**.

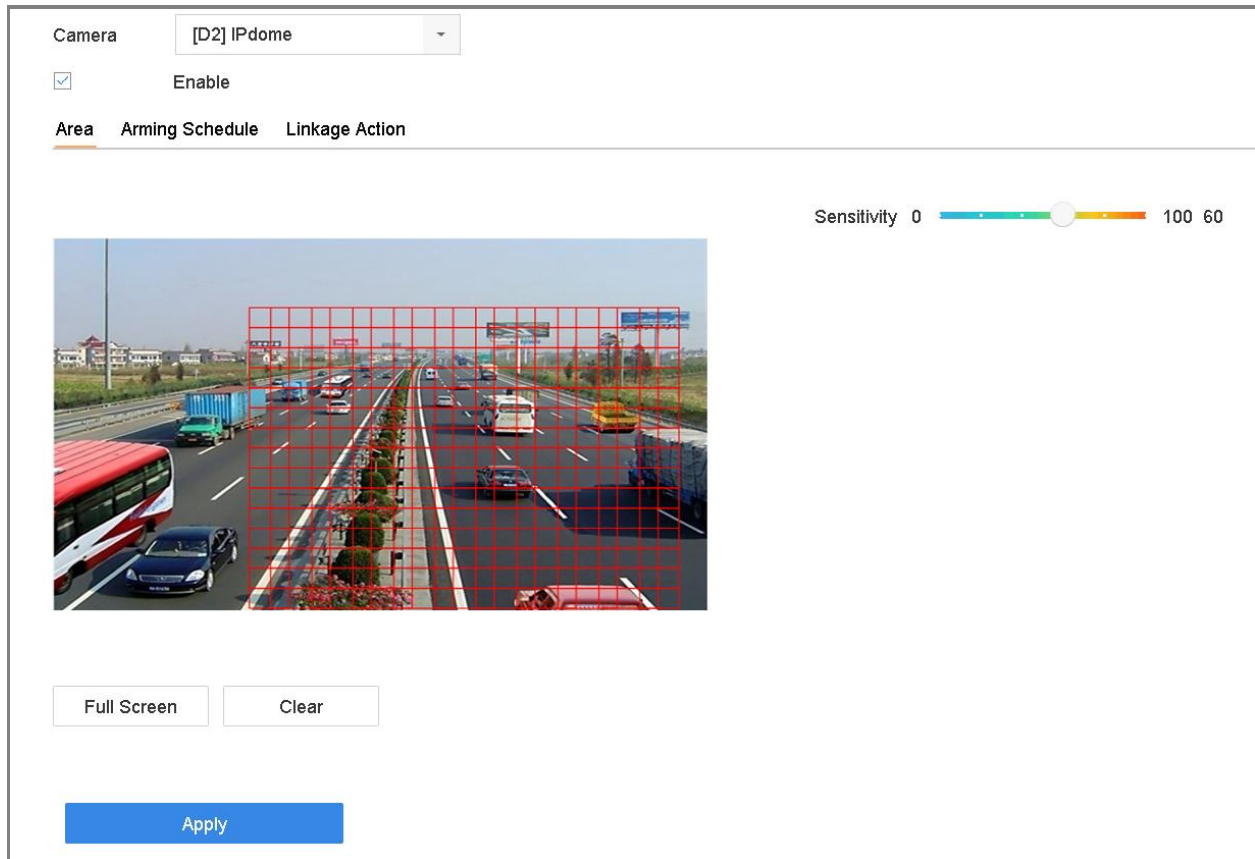

Figure 11-3 Set Motion Detection

Step 2 Select the camera to configure the motion detection.

Step 3 Check **Enable**.

Step 4 Set the motion detection area.

- Full screen: Click to set the full-screen motion detection for the image.
- Customized area: Click-and drag the mouse to click and drag on the preview screen to draw the customized motion detection area (s).

Step 5 Click **Clear** to clear the current motion detection area settings and draw again.

Step 6 Set sensitivity (0-100). The sensitivity allows you to calibrate how readily movement triggers the alarm. A higher value results in the more readily to triggers motion detection.

Step 7 Set the arming schedule. Refer to Chapter 11.1 Configure Arming Schedule.

Step 8 Set the linkage actions. Refer to Chapter 11.2 Configure Alarm Linkage Actions.

11.4 Configure Video Loss Alarms

Purpose

Video Loss Detection detects video loss of a channel and takes alarm response action(s).

Step 1 Go to **System> Event>Normal Event>Video Loss.**

Camera: [D1] IPdome

Enable

Arming Schedule | Linkage Action

Continuous None Edit

	0	2	4	6	8	10	12	14	16	18	20	22	24	
Mon	Active	Active	Active	Active	Active	Active	Active	Active	Active	Active	Active	Active	Active	1
Tue	Active	Active	Active	Active	Active	Active	Active	Active	Active	Active	Active	Active	Active	2
Wed	Active	Active	Active	Active	Active	Active	Active	Active	Active	Active	Active	Active	Active	3
Thu	Active	Active	Active	Active	Active	Active	Active	Active	Active	Active	Active	Active	Active	4
Fri	Active	Active	Active	Active	Active	Active	Active	Active	Active	Active	Active	Active	Active	5
Sat	Active	Active	Active	Active	Active	Active	Active	Active	Active	Active	Active	Active	Active	6
Sun	Active	Active	Active	Active	Active	Active	Active	Active	Active	Active	Active	Active	Active	7
Holiday	Active	Active	Active	Active	Active	Active	Active	Active	Active	Active	Active	Active	Active	8

Apply

Figure 11-4 Set Video Loss Detection

Step 2 Select the camera to configure the video loss detection.

Step 3 Check **Enable**.

Step 4 Set the arming schedule. Refer to Chapter 11.1 Configure Arming Schedule.

Step 5 Set the linkage actions. Refer to Chapter 11.2 Configure Alarm Linkage Actions.

11.5 Configure Video Tampering Alarms

Purpose

Video Tampering Detection triggered an alarm when the camera lens is covered and takes alarm response action(s).

Step 1 Go to **System> Event>Normal Event>Video Tampering**.

Step 2 Select the camera to configure the video tampering detection.

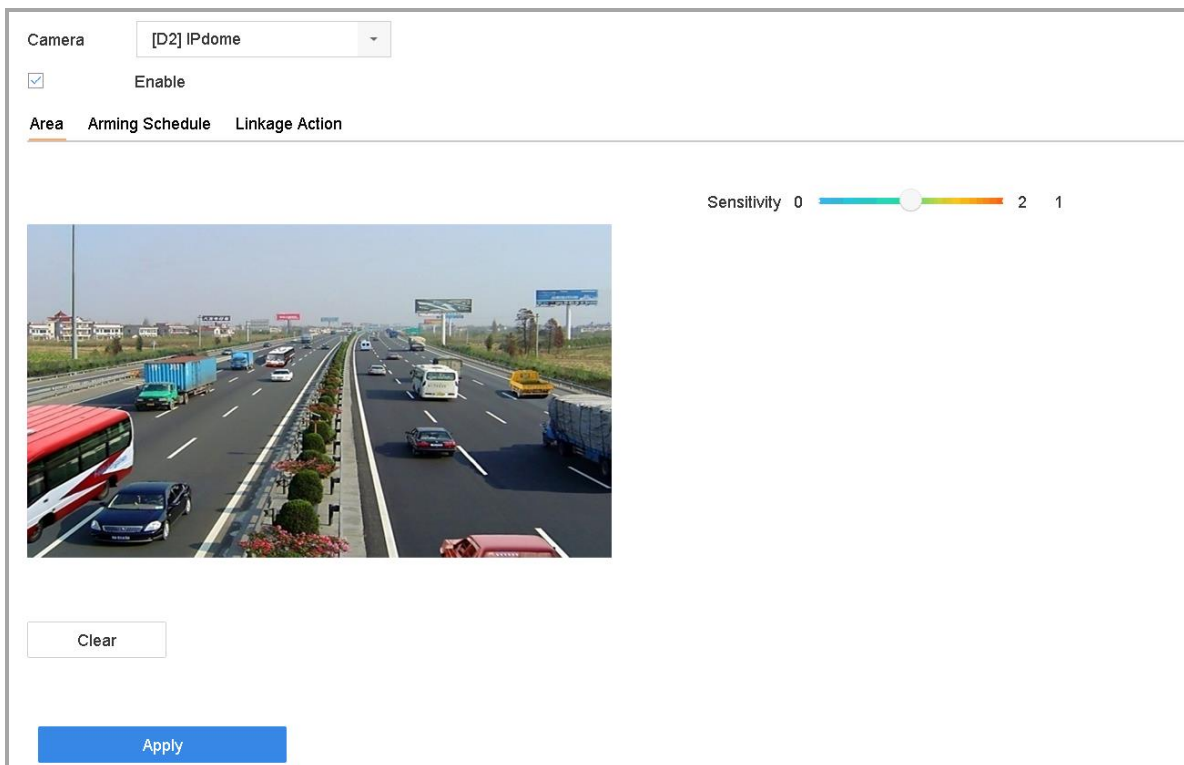

Figure 11-5 Set Video Tampering Setting

Step 3 Check **Enable**.

Step 4 Set the video tampering area. Click-and-drag the mouse on the preview screen to draw the customized video tampering area.

Step 5 Click **Clear** to clear the current area settings and draw again.

Step 6 Set sensitivity level (0-2). 3 levels are available. The sensitivity calibrates how readily movement triggers the alarm. A higher value more readily triggers the video tampering detection.

Step 7 Set the arming schedule. Refer to Chapter 11.1 Configure Arming Schedule.

Step 8 Set the linkage actions. Refer to Chapter 11.2 Configure Alarm Linkage Actions.

11.6 Configure Sensor Alarms

Purpose:

Set the handling action of an external sensor alarm.

11.6.1 Configure Alarm Inputs

Step 1 Go to **System> Event>Normal Event>Alarm Input**

Step 2 Select an alarm input item from the list and click .

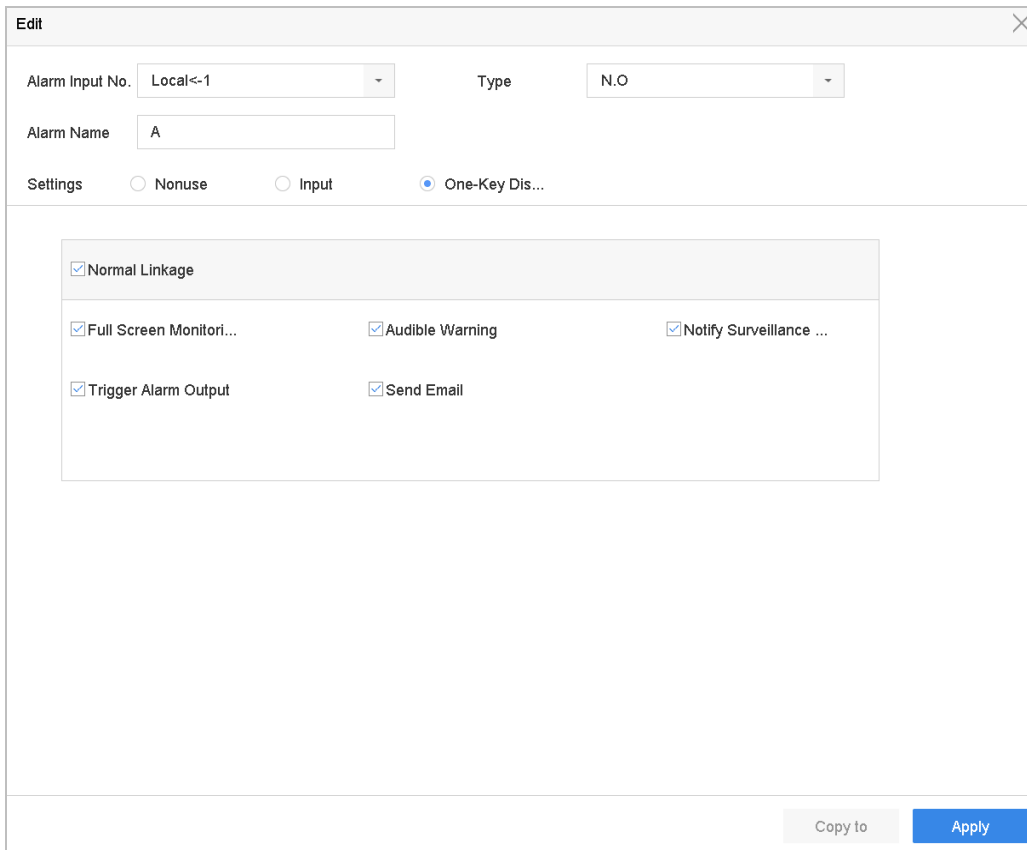

The screenshot shows the 'Edit' dialog box for an alarm input. The 'Alarm Input No.' is set to 'Local<-1' and the 'Type' is 'N.O.'. The 'Alarm Name' is 'A'. Under 'Settings', the 'One-Key Dis...' radio button is selected. The linkage actions are: Normal Linkage, Full Screen Monitori..., Audible Warning, Notify Surveillance ..., Trigger Alarm Output, and Send Email. At the bottom right are 'Copy to' and 'Apply' buttons.

Figure 11-6 Alarm Input

Step 3 Select the alarm input type to N.C or N.O.

Step 4 Edit the alarm name.

Step 5 Check **Input**.

Step 6 Set the arming schedule. Refer to Chapter 11.1 Configure Arming Schedule.

Step 7 Set the linkage actions. Refer to Chapter 11.2 Configure Alarm Linkage Actions.

11.6.2 Configure One-Key Disarming

One-Key Disarming disarm Alarm Input 1 by one-key operation.

Step 1 Go to **System> Event>Normal Event>Alarm Input**

Step 2 Select Alarm Input 1 from the list and click .

Step 3 Set the alarm input type to N.C or N.O.

Step 4 Edit the alarm name.

Step 5 Check **Enable One-Key Disarming**.

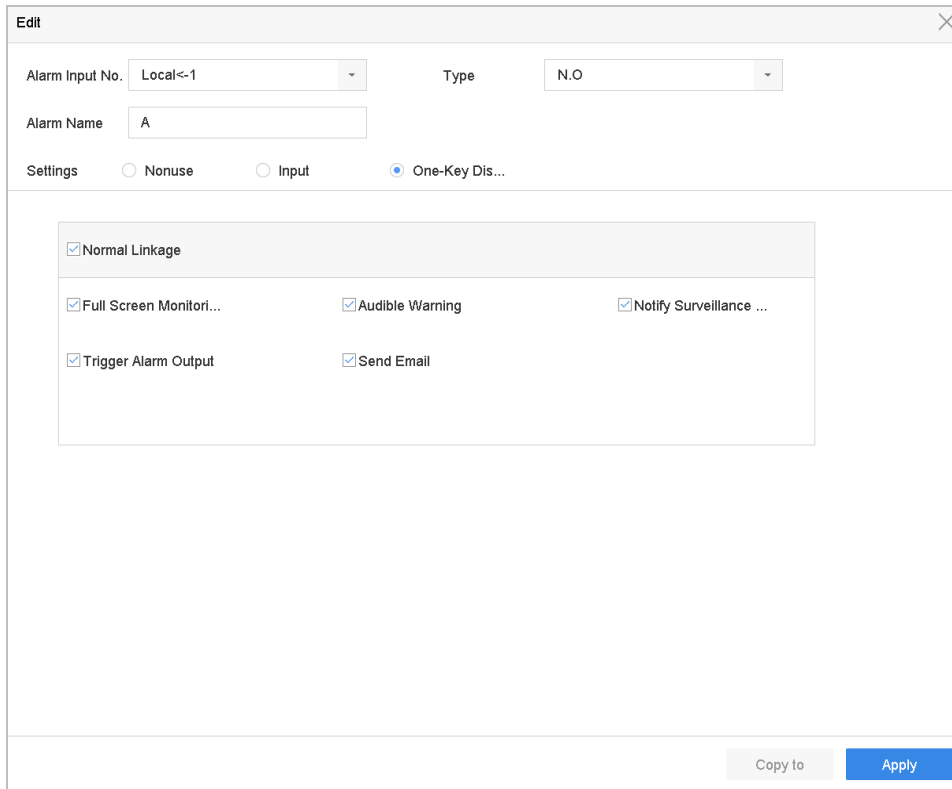

Figure 11-7 One-Key Alarm Disarming

Step 6 Select the alarm linkage action(s) you want to disarm for the local Alarm Input.

 **NOTE**

When Alarm Input 1 (Local<-1) is enabled with one-key disarming, the other alarm input settings are not configurable.

Step 7 Click **Apply** to save the settings.

11.6.3 Configure Alarm Outputs

Trigger an alarm output when an alarm is triggered.

Step 1 Go to **System> Event>Normal Event>Alarm Output**.

Step 2 Select an alarm output item from the list and click .

Step 3 Edit the alarm name.

Step 4 Select the dwell time (the alarm duration) from 5s to 600s, or **Manually Clear**.

Manually Clear: You should manually clear the alarm when the alarm occurs. Refer to Chapter 11.9 Trigger or Clear Alarm Output Manually for detailed instructions.

Step 5 Set the arming schedule. Refer to Chapter 11.1 Configure Arming Schedule.

Edit

Alarm Output No. Local->1 Dwell Time Manually Clear

Alarm Name Alarm Status Close

Arming Schedule

Continuous None **Edit**

	0	2	4	6	8	10	12	14	16	18	20	22	24	
Mon	█	█	█	█	█	█	█	█	█	█	█	█	█	1
Tue	█	█	█	█	█	█	█	█	█	█	█	█	█	2
Wed	█	█	█	█	█	█	█	█	█	█	█	█	█	3
Thu	█	█	█	█	█	█	█	█	█	█	█	█	█	4
Fri	█	█	█	█	█	█	█	█	█	█	█	█	█	5
Sat	█	█	█	█	█	█	█	█	█	█	█	█	█	6
Sun	█	█	█	█	█	█	█	█	█	█	█	█	█	7
Holiday	█	█	█	█	█	█	█	█	█	█	█	█	█	8

Trigger Copy **Apply**

Figure 11-8 Alarm Output

Step 1 (Optional) Click **Copy** to copy the same settings to other alarm output (s).

11.7 Configure Exceptions Alarms

Exception events can be configured to take the event hint in the Live View window and trigger alarm output and linkage actions.

Step 1 Go to **System> Event>Normal Event>Exception**.

Step 2 (Optional) Enable the event hint to display it in the live view window.

- 1) Check **Enable Event Hint**.
- 2) Click  to select the exception type (s) to take the event hint.

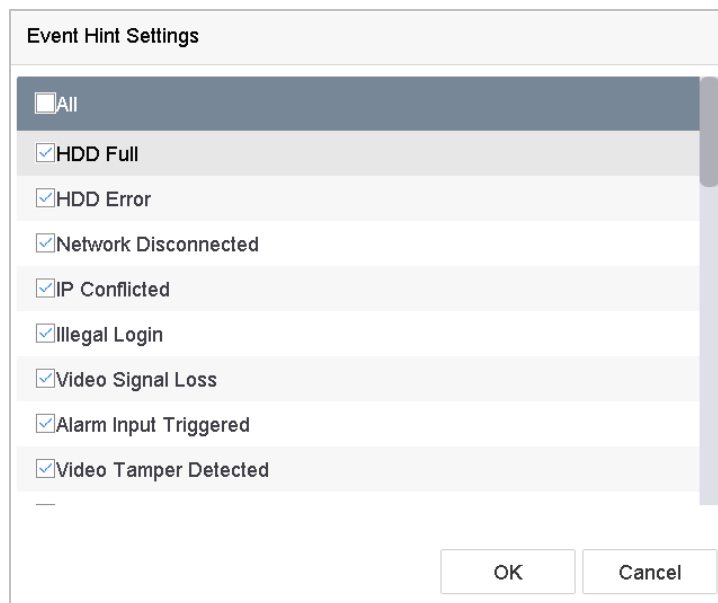

Figure 11-9 Event Hint Settings

Step 3 Select the exception type from the drop-down list to set the linkage actions.

Enable Event Hint

Event Hint Config...

Exception Type: HDD Full

<input checked="" type="checkbox"/> Normal Linkage	<input type="checkbox"/> Trigger Alarm Output
<input checked="" type="checkbox"/> Audible Warning	<input checked="" type="checkbox"/> Local->1
<input checked="" type="checkbox"/> Notify Surveillance Center	<input checked="" type="checkbox"/> Local->2
<input checked="" type="checkbox"/> Send Email	<input type="checkbox"/> Local->3
	<input type="checkbox"/> Local->4
	<input type="checkbox"/> 10.15.2.250:8000->1

Apply

Figure 11-10 Exceptions Handling

Step 4 Set the normal linkage and alarm output triggering. Refer to Chapter 11.8 Setting Alarm Linkage Actions

11.8 Setting Alarm Linkage Actions

Purpose

Alarm linkage actions will be activated when an alarm or exception occurs, including Event Hint Display, Full Screen Monitoring, Audible Warning (buzzer), Notify Surveillance Center, Trigger Alarm Output, and Send Email.

11.8.1 Configure Auto-Switch Full Screen Monitoring

When an alarm is triggered, the local monitor displays in full screen the video image from the alarming channel configured for full screen monitoring. And when the alarm is triggered simultaneously in several channels, you must configure the auto-switch dwell time.

Step 1 Go to **System > View > General**.

Step 2 Set the event output and dwell time.

- **Event Output:** Select the output to show the event video.
- **Full Screen Monitoring Dwell Time:** Set the time in seconds to show the alarm event screen. If alarms are triggered simultaneously in several channels, their full-screen images will be switched at an interval of 10 seconds (default dwell time).

Step 3 Go to the **Linkage Action** interface of the alarm detection (e.g., motion detection, video tampering, face detection, etc.).

Step 4 Select the **Full Screen Monitoring** alarm linkage action.

Step 5 Select the channel(s) in **Trigger Channel** settings you for make full screen monitoring in Trigger Channel Settings.



NOTE

Auto-switch will terminate once the alarm stops and back to the live view interface.

11.8.2 Configure Audio Warning

The audio warning has the system to trigger an audible *beep* when an alarm is detected.

Step 1 Go to **System>View>General**.

Step 2 Enable the audio output and set the volume.

Step 3 Go to the **Linkage Action** interface of the alarm detection (e.g., motion detection, video tampering, face detection, etc.).

Step 4 Select the **Audio Warning** alarm linkage action.

11.8.3 Notify Surveillance Center

The device can send an exception or alarm signal to the remote alarm host when an event occurs. The alarm host refers to the PC installed with client software (e.g., iVMS-4200, iVMS-5200).

Step 1 Go to **System > Network > Advanced > More Settings**.

Step 2 Set the alarm host IP and alarm host port.

Step 3 Go to the **Linkage Action** interface of the alarm detection (e.g., motion detection, video tampering, face detection, etc.).

Step 4 Select the **Notify Surveillance Center**.

11.8.4 Configure E-mail Linkage

The system can send an email with alarm information to a user or users when an alarm is detected.

Please refer to Chapter 15.7 Configure Email for details of Email configuration.

Step 1 Go to **System>Network>Advanced**.

Step 2 Configure the e-mail settings.

Step 3 Go to the **Linkage Action** interface of the alarm detection (e.g., motion detection, video tampering, face detection, etc.).

Step 4 Select the **Send Email** alarm linkage action.

11.8.5 Trigger Alarm Outputs

The alarm output can be triggered by the alarm input, motion detection, video tampering detection, face detection, line crossing detection, and any all other events.

Step 1 Go to the **Linkage Action** interface of the alarm detection (e.g., motion detection, face detection, line crossing detection, intrusion detection, etc.).

Step 2 Click the **Trigger Alarm Output** tab.

Step 3 Select the alarm output (s) to trigger.

Step 4 Go to **System>Event>Normal Event>Alarm Output**.

Step 5 Select an alarm output item from the list.



Refer to Chapter 11.6.3 Configure Alarm Output for the alarm output settings.

11.8.6 Configure PTZ Linkage

The system can trigger the PTZ actions (e.g., call preset/patrol/pattern) when the alarm event, or VCA detection events occurs.

 **NOTE**

Make sure the connected PTZ or speed dome connected supports PTZ linkage.

- Step 1 Go to the **Linkage Action** interface of the alarm input or VCA detection (e.g., face detection, line crossing detection, intrusion detection, etc.).
- Step 2 Select the **PTZ Linkage**.
- Step 3 Select the camera to perform the PTZ actions.
- Step 4 Select the preset/patrol/pattern No. to call when the alarm events occur.

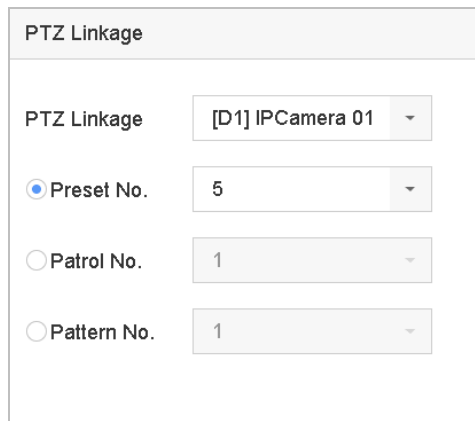

The screenshot shows a configuration window titled "PTZ Linkage". It contains four rows of settings, each with a label and a dropdown menu:

- PTZ Linkage:** [D1] IPCamera 01
- Preset No.:** 5
- Patrol No.:** 1
- Pattern No.:** 1

Figure 11-11 PTZ Linkage

 **NOTE**

You can set only one PTZ type for the linkage action each time.

11.9 Trigger or Clear Alarm Output Manually

Purpose

Sensor alarm can be triggered or cleared manually. When the **Manually Clear** is selected for the dwell time of an alarm output, the alarm can be cleared only by clicking **Clear** button.

- Step 1 Go to **System> Event>Normal Event>Alarm Output**.
- Step 2 Select the alarm output you want to trigger or clear.
- Step 3 Click **Trigger/Clear** to trigger or clear an alarm output.

Edit
✕

Alarm Output No.

Alarm Name

Dwell Time

Alarm Status

Arming Schedule

Continuous
 None
 [Edit](#)

	0	2	4	6	8	10	12	14	16	18	20	22	24	
Mon														1
Tue														2
Wed														3
Thu														4
Fri														5
Sat														6
Sun														7
Holiday														8

Trigger Copy Apply

Figure 11-12 Alarm Output

Chapter 12 VCA Event Alarm

The device supports receiving VCA detections sent by connected IP cameras. Enable and configure VCA detection on the IP camera settings interface first.

 **NOTE**

- VCA detections must be supported by the connected IP camera.
- Refer to the network camera’s user manual for detailed VCA detection instructions.

12.1 Face Detection

Purpose

The Face Detection function detects the face appearing in the surveillance scene. Linkage actions can be triggered when a human face is detected.

Step 1 Go to **System > Event > Smart Event**.

Step 2 Click **Face Detection**.

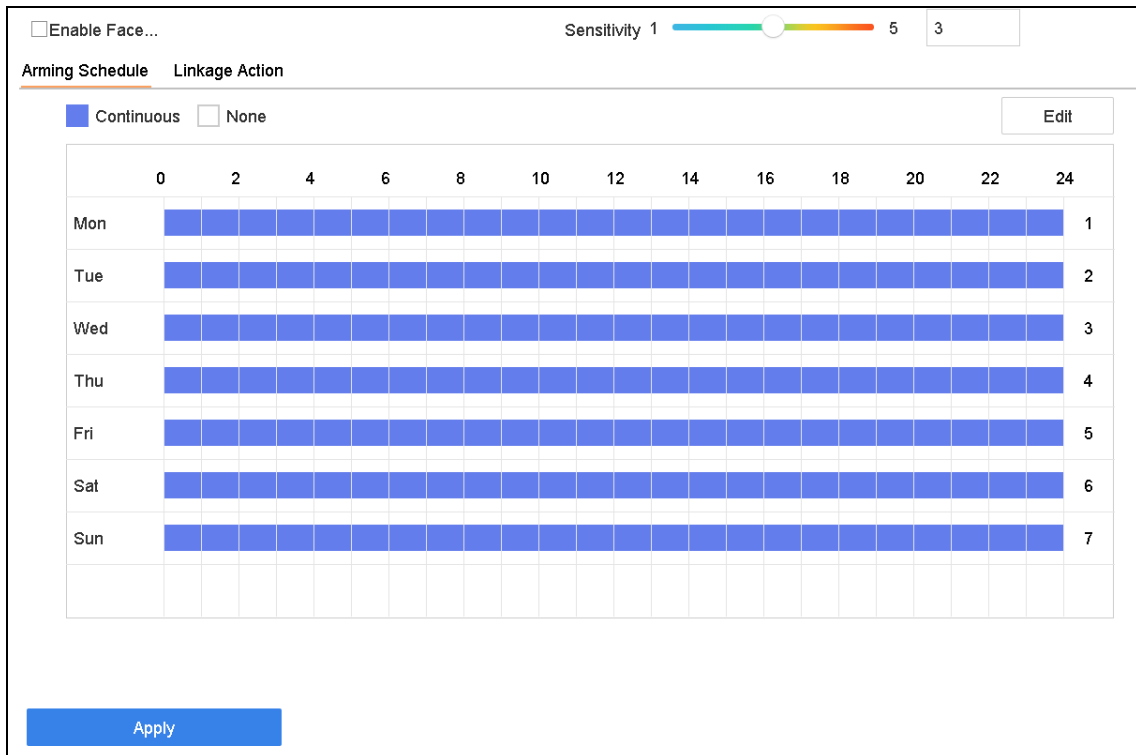

Figure 12-1 Face Detection

Step 3 Select a **Camera** to configure.

Step 4 Check **Enable Face Detection**.

Step 5 Optionally, check **Save VCA Picture** to save the captured pictures of face detection.

Step 6 Drag the **Sensitivity** slider to set the detection sensitivity. Sensitivity range: [1-5]. The higher the value is, the more easily the face will be detected.

Step 7 Set the arming schedule. Refer to Chapter 11.1 Configure Arming Schedule.

Step 8 Set the linkage actions. Refer to Chapter 11.2 Configure Alarm Linkage Actions.

Step 9 Click **Apply**.

12.2 Vehicle Detection

Purpose

Vehicle Detection is available for road traffic monitoring. In Vehicle Detection, a passed vehicle can be detected and the picture of its license plate can be captured. You can send an alarm signal to notify the surveillance center and upload the captured picture to an FTP server.

Step 1 Go to **System > Event > Smart Event**.

Step 2 Click **Vehicle**.

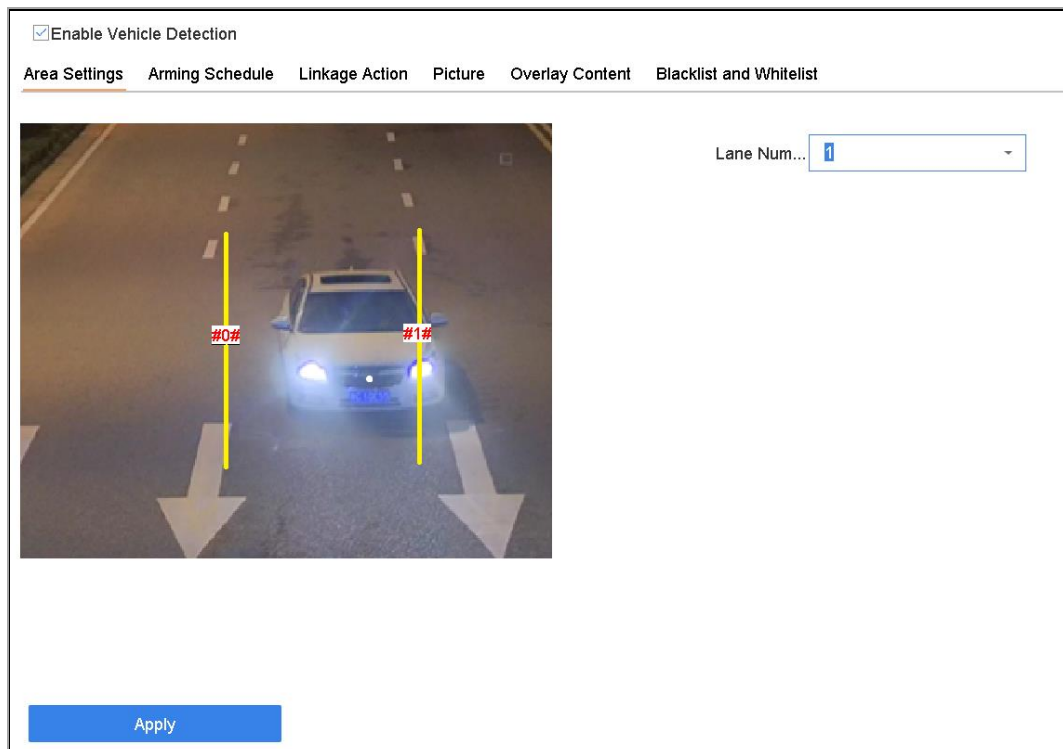

Figure 12-2 Vehicle Detection

Step 3 Select a camera to configure.

Step 4 Check **Enable Vehicle Detection**.

Step 5 Optionally, check **Save VCA Picture** to save the captured vehicle detection pictures.

Step 6 Set the arming schedule. Refer to Chapter 11.1 Configure Arming Schedule.

Step 7 Set the linkage actions. Refer to Chapter 11.2 Configure Alarm Linkage Actions.

Step 8 Configure rules, including **Area Settings, Picture, Overlay Content,** and **Blacklist and Whitelist.**
Area Settings: Up to 4 lanes are selectable.

Step 9 Click **Save**.



Refer to the Network Camera User Manual for detailed instructions for the vehicle detection.

12.3 Line Crossing Detection

Purpose

Line crossing detection detects people, vehicles, and objects crossing a set virtual line. The detection direction can be set as bidirectional, from left to right or from right to left.

Step 1 Go to **System > Event > Smart Event**.

Step 2 Click **Line Crossing**.

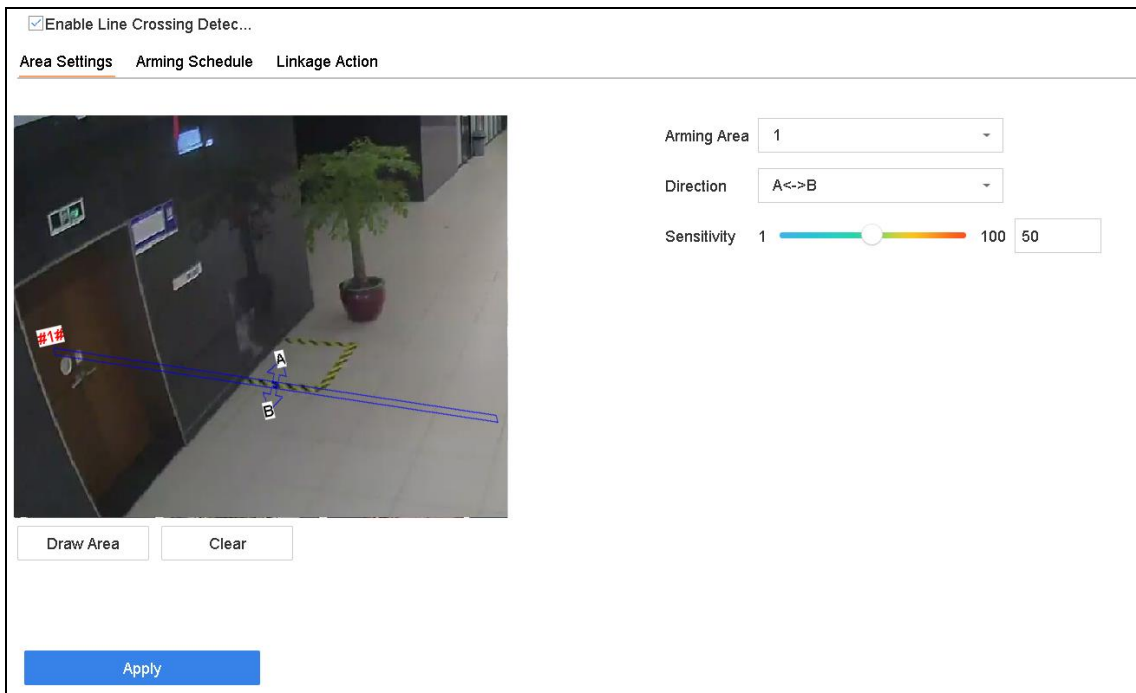

Figure 12-3 Line Crossing Detection

Step 3 Select a **camera** to configure.

Step 4 Check the **Enable Line Crossing Detection** checkbox.

Step 5 Optionally, check **Save VCA Picture** to save the captured pictures of line crossing detection pictures.

Step 6 Follow the steps to set the line crossing detection rules and detection areas.

- 1) Select an Arming Region to configure. Up to 4 arming regions are selectable.
- 2) Select the Direction as A<->B, A->B, or A<-B.

A<->B: Only the arrow on the B side shows. An object crossing a configured line in both directions can be detected and trigger alarms.

A->B: Only an object crossing the configured line from the A side to the B side can be detected.

B->A: Only an object crossing the configured line from the B side to the A side can be detected.

- 3) Drag the Sensitivity slider to set the detection sensitivity. Sensitivity range: sensitivity. The higher the value is, the more easily the detection alarm will be triggered.
- 4) Click Draw Region and set two points in the preview window to draw a virtual line.

Step 7 Set the arming schedule. Refer to Chapter 11.1 Configure Arming Schedule.

Step 8 Set the linkage actions. Refer to Chapter 11.2 Configure Alarm Linkage Actions.

Step 9 Click Apply.

12.4 Intrusion Detection

Purpose

The Intrusion Detection Function detects people, vehicles or other objects that enter and loiter in a pre-defined virtual region. Specific actions can be taken when an alarm is triggered.

Step 1 Go to **System > Event > Smart Event**.

Step 2 Click **Intrusion**.

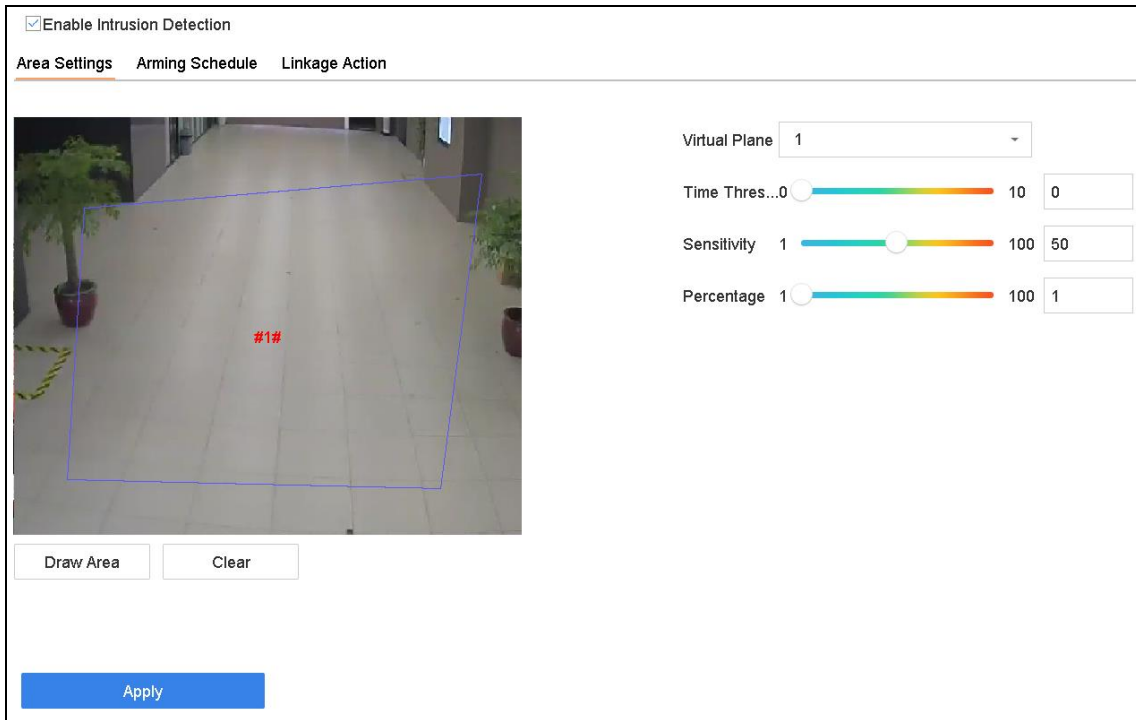

Figure 12-4 Intrusion Detection

Step 3 Select a **camera** to configure.

Step 4 Check **Enable Intrusion Detection**.

Step 5 Optionally, check **Save VCA Picture** to save the captured intrusion detection pictures.

Step 6 Follow these steps to set the detection rules and detection areas.

- 1) Select a Virtual Panel to configure. Up to 4 virtual panels are selectable.
- 2) Drag the sliders to set Time Threshold, Sensitivity, and Percentage.

Time Threshold: The time an object loiter in the region. When the duration of the object in the defined detection area exceeds the threshold, the device will trigger an alarm. Its range is [1s-10s].

Sensitivity: The size of the object that can trigger the alarm. The higher the value is, the more easily the detection alarm will be triggered. Its range is [1-100].

Percentage: The ratio of the in-region part of the object that can trigger the alarm. For example, if the percentage is 50%, when the object enters the region and occupies half of the whole region, the device will trigger an alarm. Its range is [1-100].

- 3) Click Draw Region and draw a quadrilateral in the preview window by specifying four vertices of the detection region.

Step 7 Set the arming schedule. Refer to Chapter 11.1 Configure Arming Schedule.

Step 8 Set the linkage actions. Refer to Chapter 11.2 Configure Alarm Linkage Actions.

Step 9 Click **Apply**.

12.5 Region Entrance Detection

Purpose

The Region Entrance Detection Function detects objects that enter a pre-defined virtual region.

Step 1 Go to **System Management > Event Settings > Smart Event**.

Step 2 Click the **Region Entrance Detection** item.

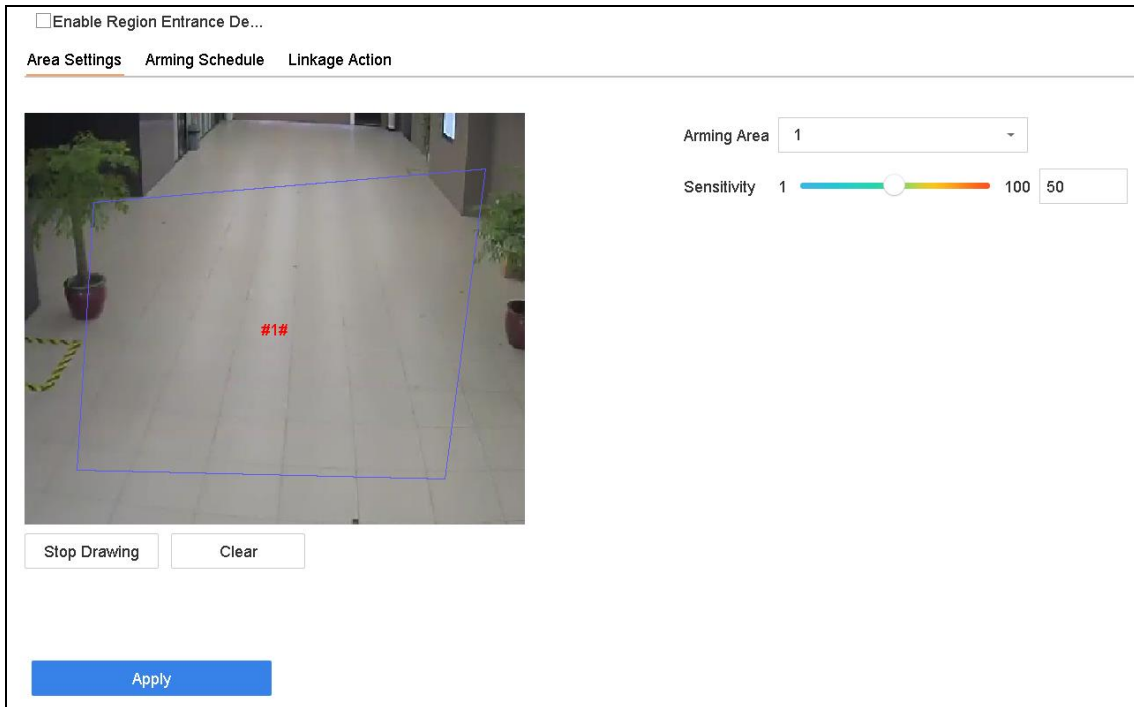

Figure 12-5 Region Entrance Detection

Step 3 Select a **camera** to configure.

Step 4 Check **Enable Region Entrance Detection**.

Step 5 Optionally, check **Save VCA Picture** to save the captured pictures of region entrance detection pictures.

Step 6 Follow thees steps to set the detection rules and detection areas.

- 1) Select an Arming Region to configure. Up to 4 regions are selectable.
- 2) Drag the sliders to set Sensitivity.

Sensitivity: The higher the value is, the more easily the detection alarm will be triggered. Its range is [0-100].

- 3) Click **Draw Region** and draw a quadrilateral in the preview window by specifying four vertices of the detection region.

Step 7 Configure **Arming Schedule** and **Linkage Action**.

Step 8 Click **Apply**.

12.6 Region Exiting Detection

Purpose

The Region Exiting Detection Function detects objects that exit from a pre-defined virtual region.

Step 1 Go to **System > Event > Smart Event**.

Step 2 Click **Region Exiting**.

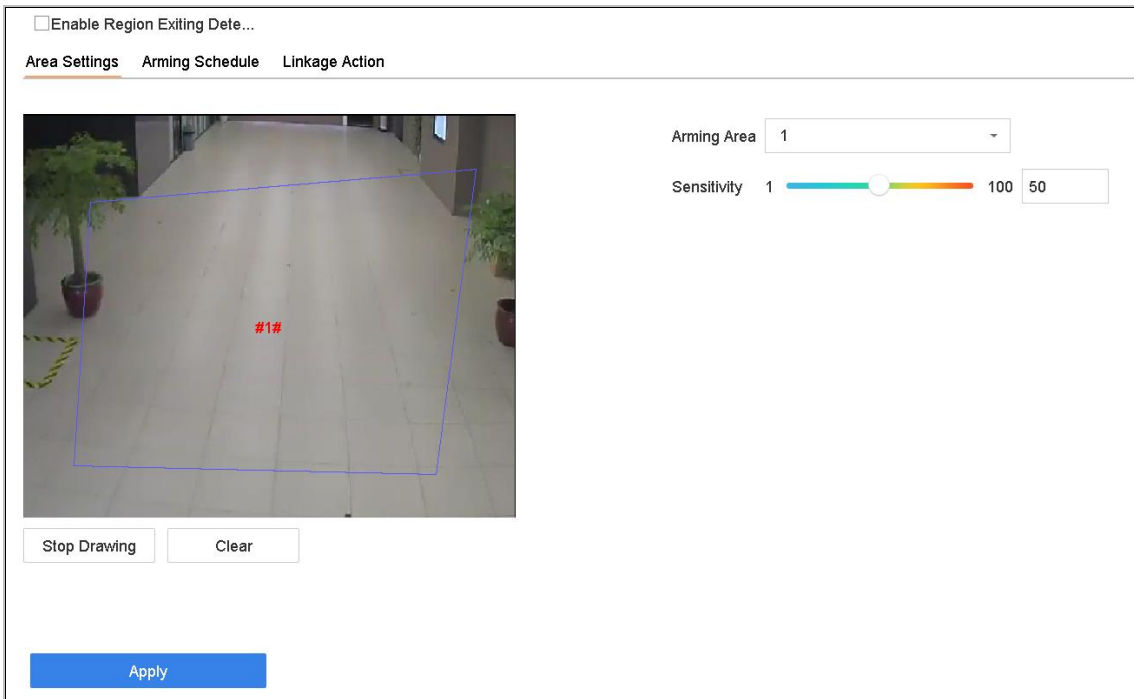

Figure 12-6 Region Exiting Detection

Step 3 Select a **camera** to configure.

Step 4 Check **Enable Region Exiting Detection**.

Step 5 Optionally, check **Save VCA Picture** to save the captured region exiting detection pictures.

Step 6 Follow these steps to set the detection rules and detection areas.

- 1) Select an Arming Region to configure. Up to 4 regions are selectable.
- 2) Drag the sliders to set Sensitivity.

Sensitivity: The higher the value is, the more easily the detection alarm will be triggered. Its range is [0-100].

- 3) Click Draw Region and draw a quadrilateral in the preview window by specifying four vertices of the detection region.

Step 7 Set the arming schedule. Refer to Chapter 11.1 Configure Arming Schedule.

Step 8 Set the linkage actions. Refer to Chapter 11.2 Configure Alarm Linkage Actions.

Step 9 Click **Apply**.

12.7 Unattended Baggage Detection

Purpose

The Unattended Baggage Detection Function detects the objects left over in a pre-defined region such as the baggage, purses, dangerous materials, etc., and a series of actions can be taken when the alarm is triggered.

Step 1 Go to **System > Event > Smart Event**.

Step 2 Click **Unattended Baggage**.

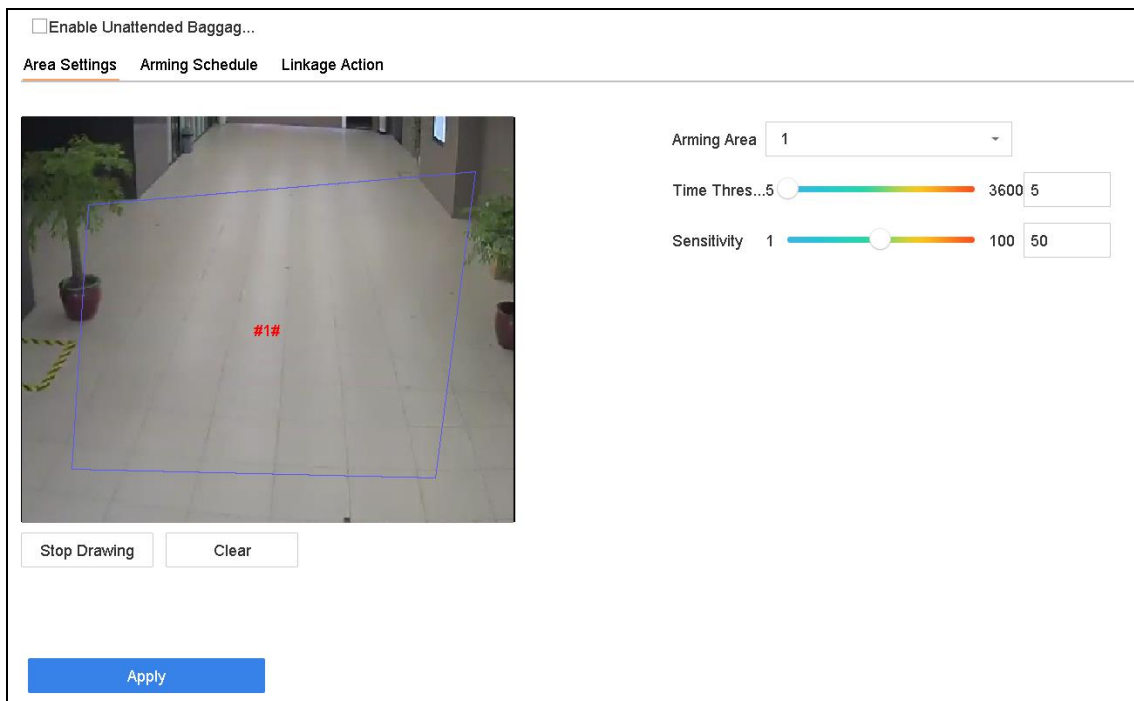

Figure 12-7 Unattended Baggage Detection

Step 3 Select a **camera** to configure.

Step 4 Check **Enable Unattended Baggage Detection**.

Step 5 Optionally, check **Save VCA Picture** to save the captured unattended baggage detection pictures.

Step 6 Follow these steps to set the detection rules and detection areas.

- 1) Select an **Arming Region** to configure. Up to 4 regions are selectable.
- 2) Drag the sliders to set **Time Threshold** and **Sensitivity**.

Time Threshold: The time of the objects are left in the region. If the value is 10, an alarm is triggered after the object is left and stayed in the region for 10s. Its range is [5s-20s].

Sensitivity: Similarity of the background image to the object. The higher the value, the more easily the detection alarm will be triggered.

- 3) Click **Draw Region** and draw a quadrilateral in the preview window by specifying four vertices of the detection region.

Step 7 Set the arming schedule. Refer to Chapter 11.1 Configure Arming Schedule.

Step 8 Set the linkage actions. Refer to Chapter 11.2 Configure Alarm Linkage Actions.

Step 9 Click **Apply**.

12.8 Object Removal Detection

Purpose

The Object Removal Detection function detects the objects removed from a pre-defined region, such as the exhibits on display, and a series of actions can be taken when the alarm is triggered.

Step 1 Go to **System > Event > Smart Event**.

Step 2 Click **Object Removable**.

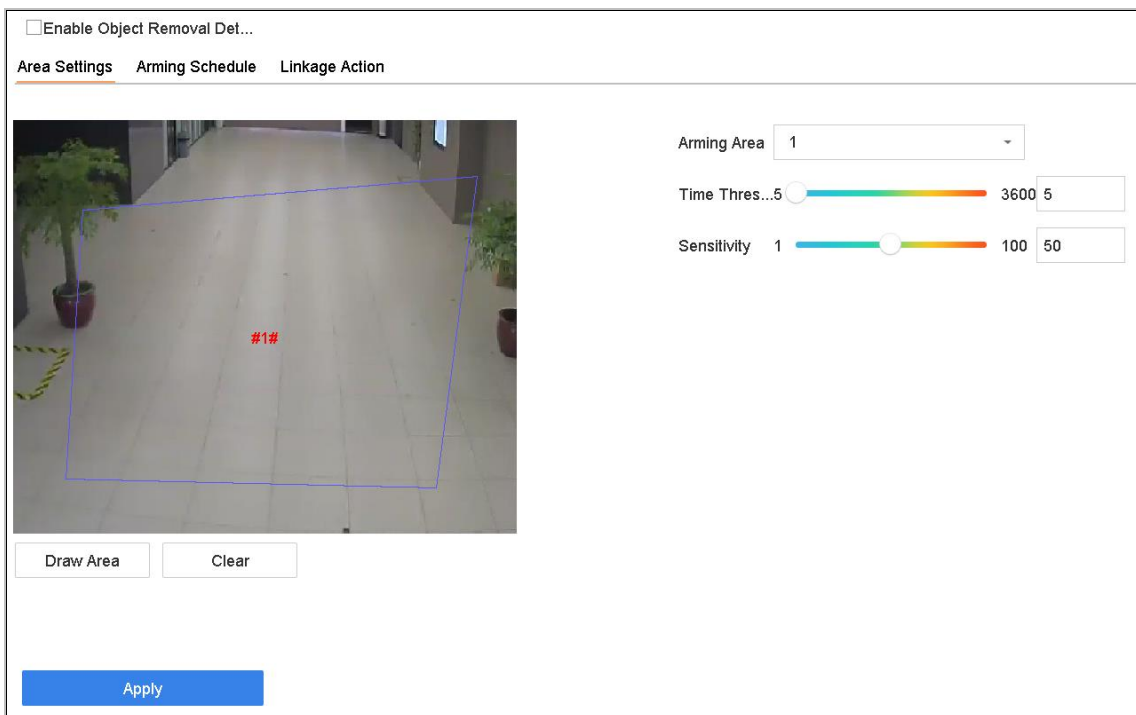

Figure 12-8 Object Removal Detection

Step 3 Select a **camera** to configure.

Step 4 Check **Enable Object Removable Detection**.

Step 5 Optionally, check **Save VCA Picture** to save the captured object removable detection pictures.

Step 6 Follow these steps to set the detection rules and detection areas.

- 1) Select an Arming Region to configure. Up to 4 regions are selectable.
- 2) Drag the sliders to set Time Threshold and Sensitivity.

Time Threshold: The time of the objects removed from the region. If the value is 10, alarm will be triggered after the object disappears from the region for 10s. Its range is [5s-20s].

Sensitivity: The similarity degree of the background image. If the sensitivity is high, a very small object taken from the region will trigger the alarm.

- 3) Click **Draw Region** and draw a quadrilateral in the preview window by specifying four vertices of the detection region.

Step 7 Set the arming schedule. Refer to Chapter 11.1 Configure Arming Schedule.

Step 8 Set the linkage actions. Refer to Chapter 11.2 Configure Alarm Linkage Actions.

Step 9 Click **Apply**.

12.9 Audio Exception Detection

Purpose

Audio exception detection detects abnormal sounds in the surveillance scene, such as a sudden increase/decrease in sound intensity.

Step 1 Go to **System > Event > Smart Event**.

Step 2 Click **Audio Exception**.

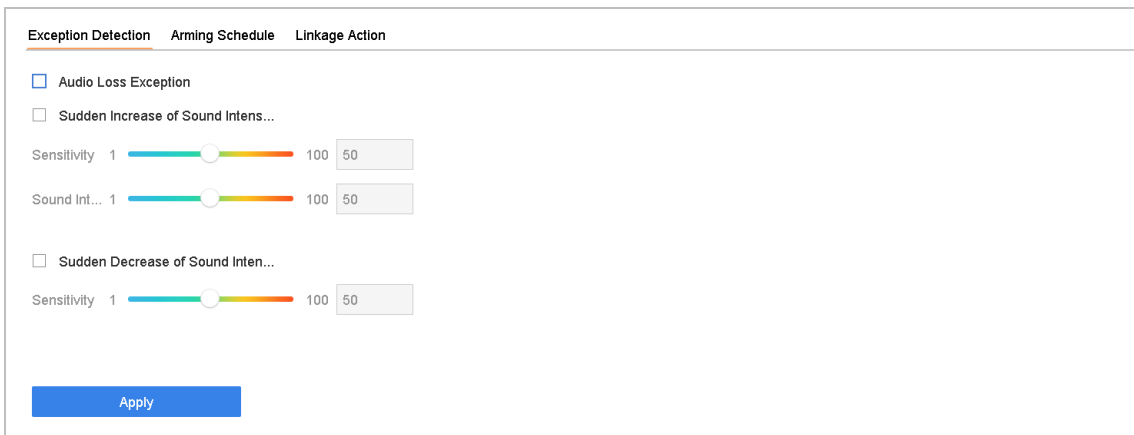

Figure 12-9 Audio Exception Detection

Step 3 Select a **camera** to configure.

Step 4 Optionally, check **Save VCA Picture** to save the captured audio exception detection pictures.

Step 5 Set the detection rules:

- 1) Select the **Exception Detection** tab.
- 2) Check **Audio Loss Exception, Sudden Increase of Sound Intensity Detection, and/or Sudden Decrease of Sound Intensity Detection**.

Audio Loss Exception: Detects a steep sound rise in the surveillance scene. You can set the detection sensitivity and threshold for steep sound rise by configuring its **Sensitivity** and **Sound Intensity Threshold**.

Sensitivity: The smaller the value, the more severe the change must be to trigger the detection. Range [1-100].

Sound Intensity Threshold: It can filter the sound in the environment. The louder the environment sound, the higher the value should be. Adjust it according to the environment. Range [1-100].

Sudden Decrease of Sound Intensity Detection: Detects a steep sound drop in the surveillance scene. You need set the detection sensitivity [1-100].

Step 6 Set the arming schedule. Refer to Chapter 11.1 Configure Arming Schedule.

Step 7 Set the linkage actions. Refer to Chapter 11.2 Configure Alarm Linkage Actions.

Step 8 Click **Apply**.

12.10 Sudden Scene Change Detection

Purpose

Scene change detection detects the change of the surveillance environment affected by external factors, such as the intentional rotation of the camera.

Step 1 Go to **System > Event > Smart Event**.

Step 2 Click **Sudden Scene Change**.

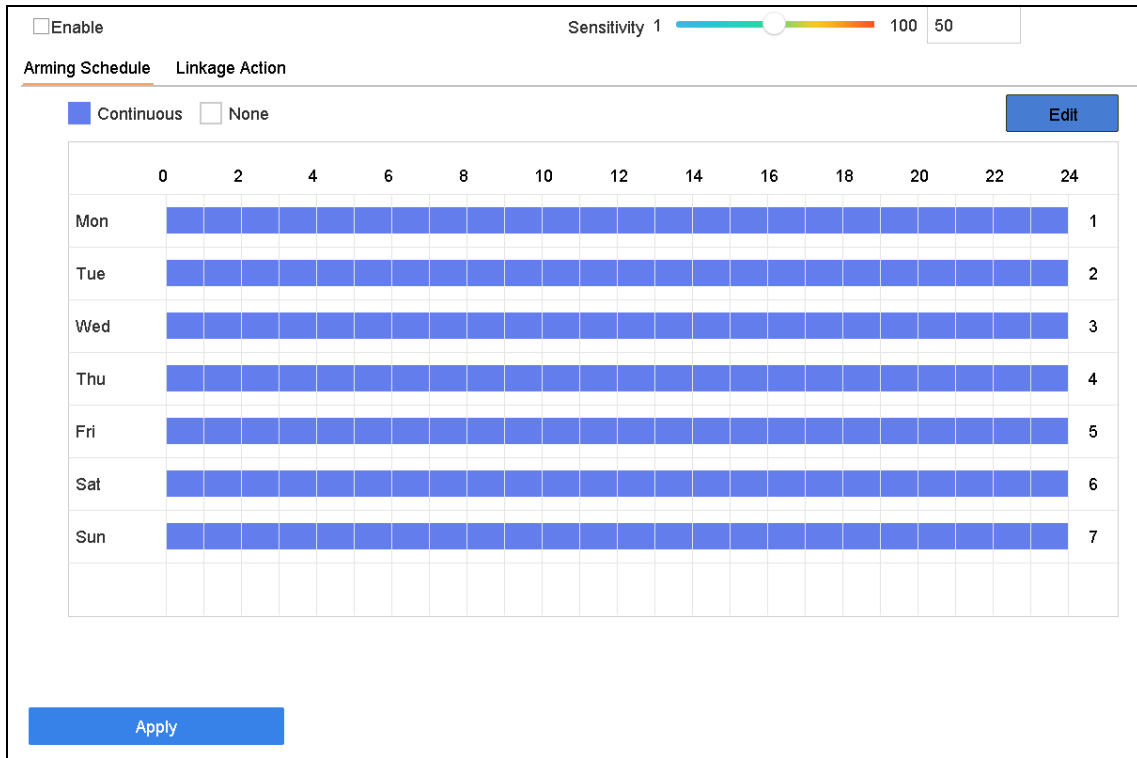

Figure 12-10 Sudden Scene Change

Step 3 Select a **camera** to configure.

Step 4 Check **Enable Sudden Scene Change Detection**.

Step 5 Optionally, check **Save VCA Picture** to save the captured sudden scene change detection pictures.

Step 6 Drag the **Sensitivity** slider to set the detection sensitivity. Sensitivity range: [1-100]. The higher the value, the more easily the change of scene can trigger the alarm.

Step 7 Set the arming schedule. Refer to Chapter 11.1 Configure Arming Schedule.

Step 8 Set the linkage actions. Refer to Chapter 11.2 Configure Alarm Linkage Actions.

Step 9 Click **Apply**.

12.11 Defocus Detection

Purpose

Image blur caused by lens defocus can be detected.

Step 1 Go to **System > Event > Smart Event**.

Step 2 Click **Defocus**.

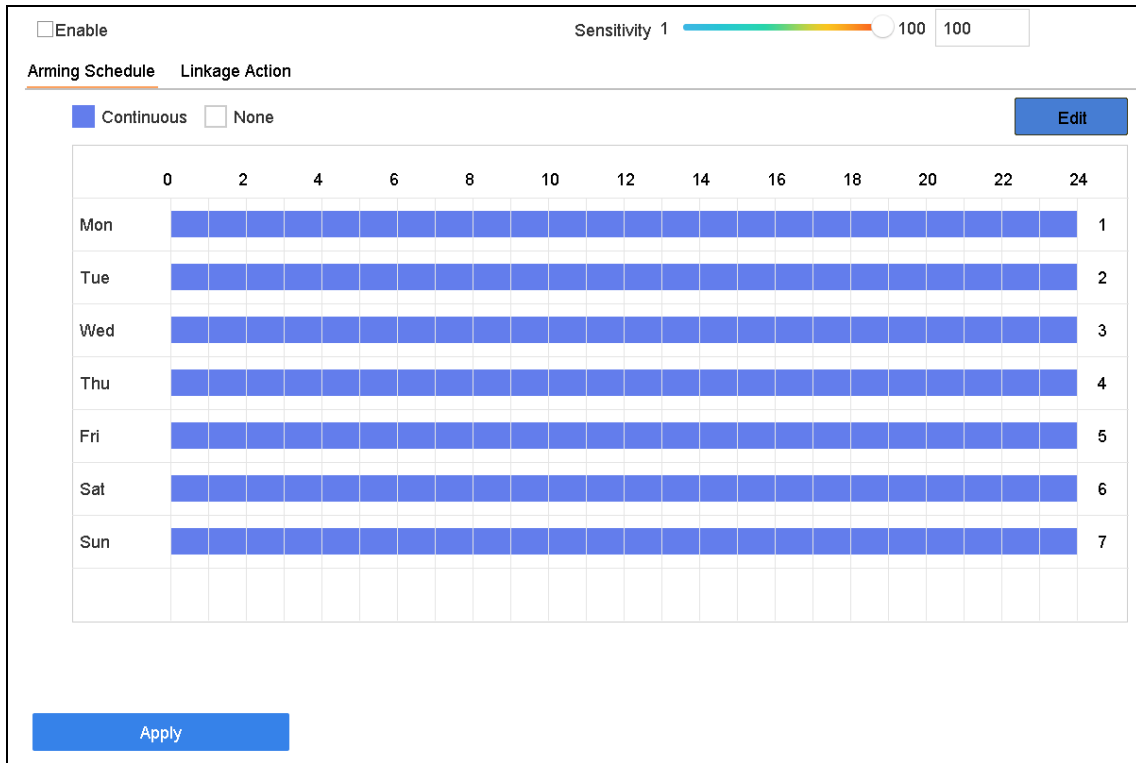

Figure 12-11 Defocus Detection

Step 3 Select a **camera** to configure.

Step 4 Check **Enable Defocus Detection**.

Step 5 Optionally, check **Save VCA Picture** to save the captured defocus detection pictures.

Step 6 Drag the **Sensitivity** slider to set the detection sensitivity. Sensitivity range: [1-100]. The higher the value, the more easily the defocus image will be detected.

Step 7 Set the arming schedule. Refer to Chapter 11.1 Configure Arming Schedule.

Step 8 Set the linkage actions. Refer to Chapter 11.2 Configure Alarm Linkage Actions.

Step 9 Click **Apply**.

12.12 PIR Alarm

Purpose

A PIR (Passive Infrared) alarm is triggered when an intruder moves within the detector vision field. The heat energy dissipated by a person or any other warm blooded creature such as dogs, cats, etc., can be detected.

Step 1 Go to **System > Event > Smart Event**.

Step 2 Click **PIR Alarm**.

Enable PIR Alarm

Arming Schedule Linkage Action

Continuous None Edit

	0	2	4	6	8	10	12	14	16	18	20	22	24	
Mon	[Armed]													1
Tue	[Armed]													2
Wed	[Armed]													3
Thu	[Armed]													4
Fri	[Armed]													5
Sat	[Armed]													6
Sun	[Armed]													7

Apply

Figure 12-12 FIR Alarm

Step 3 Select a **camera** to configure.

Step 4 Check **PIR Alarm**.

Step 5 Optionally, check **Save VCA Picture** to save the captured of PIR alarm pictures.

Step 6 Set the arming schedule. Refer to Chapter 11.1 Configure Arming Schedule.

Step 7 Set the linkage actions. Refer to Chapter 11.2 Configure Alarm Linkage Actions.

Step 8 .Click **Apply**.

12.13 Thermal Camera Detection

The NVR supports the event detection modes of the thermal network cameras: fire and smoke detection, temperature detection, temperature difference detection, etc.

Before you start

Add the thermal network camera to your device and make sure the camera is activated.

Step 1 Go to **System > Event > Smart Event**.

Step 2 Select a thermal camera from the camera list.

Step 3 (Optional) Check **Save VCA Picture** to save the captured pictures of detection.

Step 4 Select an event detection (Temperature, etc.).

Step 5 Set the arming schedule. Refer to Chapter 11.1 Configure Arming Schedule.

Step 6 Set the linkage actions. Refer to Chapter 11.2 Configure Alarm Linkage Actions.

Step 7 Click **Apply**.

Chapter 13 Smart Analysis

With the configured VCA detection, the device supports smart analysis for people counting and heat map.

13.1 People Counting

Purpose

Counting calculates the number of people entering or leaving a certain configured area and creates daily/weekly/monthly/annual reports for analysis.

Step 1 Go to **Smart Analysis > Counting**.

Step 2 Select the camera.

Step 3 Select the report type to **Daily Report, Weekly Report, Monthly Report, or Annual Report**.

Step 4 Set the **Date** to analyze. The people counting graphic will show.

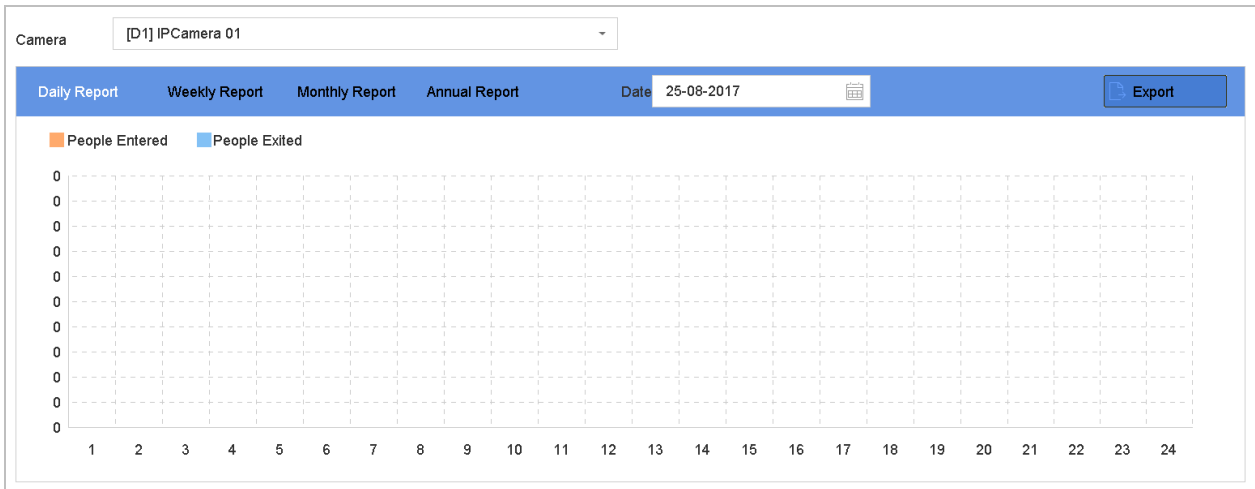

Figure 13-1 People Counting Interface

Step 5 (Optional) Click **Export** to export the report in Microsoft Excel format.

13.2 Heat Map

Purpose

Heat Map is a graphical representation of data. The heat map function is used to analyze how many people visited and stayed in a specific area.

The Heat Map function must be supported by the connected IP camera and the corresponding configuration must be set.

Step 1 Go to **Smart Analysis > Heat Map**.

Step 2 Select a camera.

Step 3 Select the report type as **Daily Report, Weekly Report, Monthly Report, or Annual Report**.

Step 4 Set the **Data** to analyze.

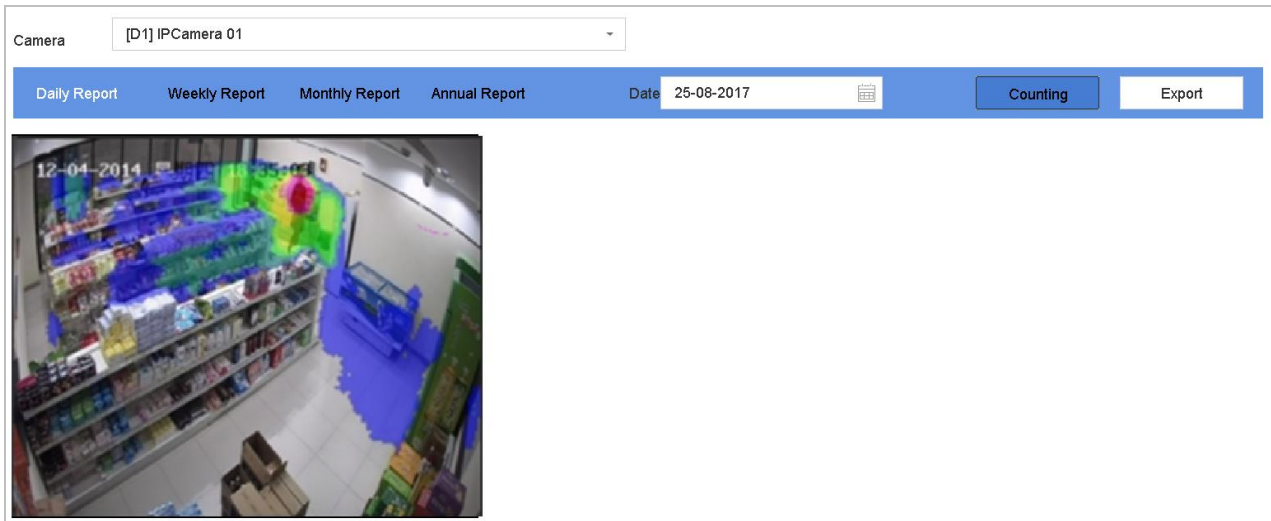

Figure 13-2 Heat Map Interface

Step 5 Click **Counting**. The results will be displayed in graphics marked in different colors.

NOTE

As shown in the figure above, red color block (255, 0, 0) indicates the most trafficked area, and blue color block (0, 0, 255) indicates the less-popular area.

Step 6 (Optional) Click **Export** to export the statistics report in Microsoft Excel format.

Chapter 14 POS Configuration

The device can be connected to a POS machine/server, and receive a transaction message to overlay on the image during Live View or playback, as well as trigger a POS event alarm.



The POS feature is supported by DS-9600/7700/7600-I (/P) Series Device only.

14.1 Configure POS Settings

14.1.1 Configure POS Connection

Step 1 Go to **System > POS**.

Step 2 Click **Add** to enter the POS adding interface.

Step 3 Select a POS device from the drop-down list.

Step 4 Check **Enable**.



The number of POS devices supported by each device is the half of its number of channel, e.g., 8 POS devices are supported for the DS-9616NI-I8 model.

Figure 14-1 POS Settings

Step 5 Select the POS protocol to Universal Protocol, EPSON, AVE, or NUCLEUS.



When a new protocol is selected, reboot the device to activate the new settings.

- Universal Protocol

Click **Advanced** to expand more settings when selecting the universal protocol. You can set the start line identifier, line break tag, and end line tag for the POS overlay characters, and the case-sensitive property of the characters. You can also optionally check the filtering identifier and the XML protocol.

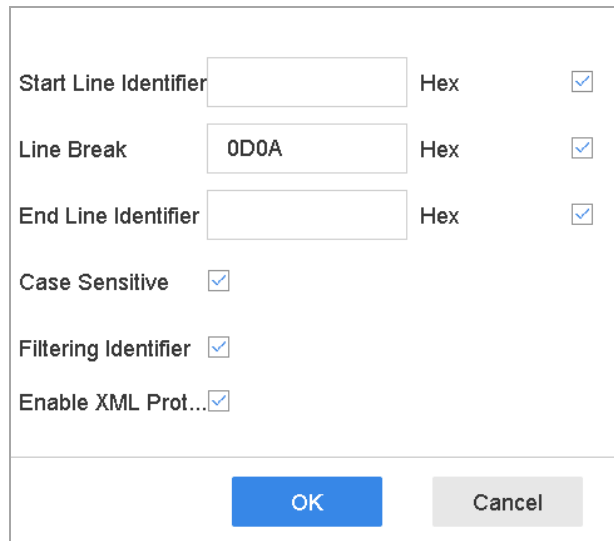

The dialog box contains the following settings:

Start Line Identifier	<input type="text"/>	Hex	<input checked="" type="checkbox"/>
Line Break	0D0A	Hex	<input checked="" type="checkbox"/>
End Line Identifier	<input type="text"/>	Hex	<input checked="" type="checkbox"/>
Case Sensitive	<input checked="" type="checkbox"/>		
Filtering Identifier	<input checked="" type="checkbox"/>		
Enable XML Prot...	<input checked="" type="checkbox"/>		

Buttons: OK, Cancel

Figure 14-2 Universal Protocol Settings

● EPSON

The fixed start and end line tag are used for EPSON protocol.

● AVE

The fixed start and end line tag are used for AVE protocol. Serial port and virtual serial port connection types are supported.

- 1) Click **Custom** to configure the AVE settings.
- 2) Set the rule to VSI-ADD or VNET.
- 3) Set the address bit of the POS message to send.
- 4) Click **OK** to save the settings.

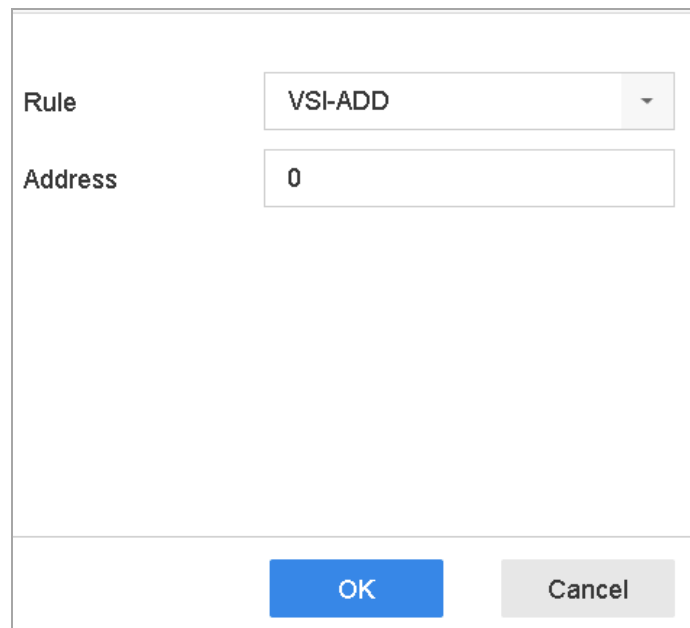

The dialog box contains the following settings:

Rule	VSI-ADD
Address	0

Buttons: OK, Cancel

Figure 14-3 AVE Settings

● NUCLEUS

- 1) Click the **Custom** to configure the NUCLEUS settings.
- 2) Enter the employee No., shift No., and the terminal No. in the field. The matching message sent from the POS device will be used as the valid POS data.

 **NOTE**

The NUCLEUS protocol must be used in the RS-232 connection communication.

Step 6 Set the connection mode to **TCP Reception**, **UDP Reception**, **Multicast**, **RS-232**, **USB-to-RS-232**, or **Sniff**, and click **Parameters** to configure the parameters for each connection mode.

● TCP Connection

- 1) When using TCP connection, the port must be set from 1 to 65535, and the port for each POS machine must be unique.
- 2) Set the **Allowed Remote IP Address** of the device sending the POS message.

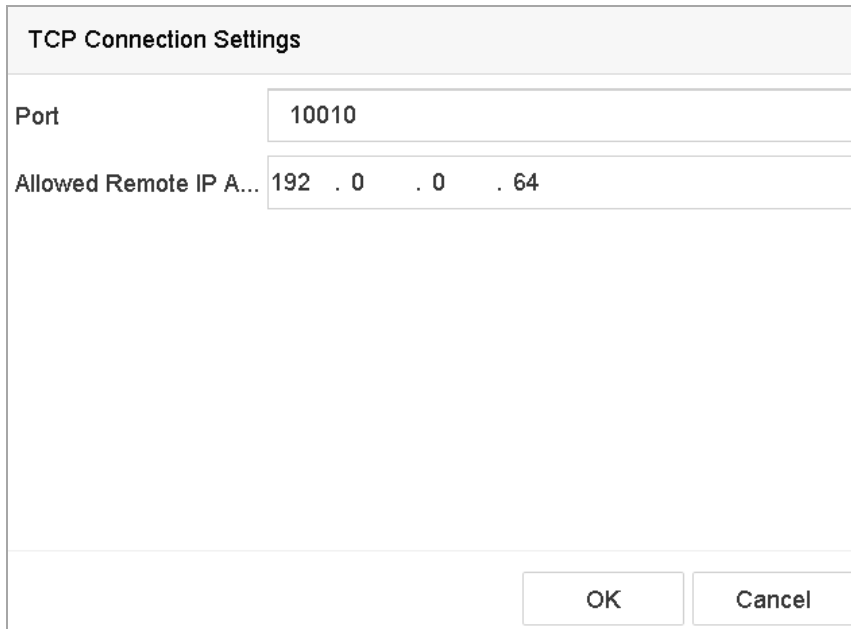

The screenshot shows a dialog box titled "TCP Connection Settings". It contains two input fields: "Port" with the value "10010" and "Allowed Remote IP A..." with the value "192 . 0 . 0 . 64". At the bottom right, there are "OK" and "Cancel" buttons.

Figure 14-4 TCP Connection Settings

● UDP Connection

- 1) When using UDP connection, the port must be set from 1 to 65535, and the port for each POS machine must be unique.
- 2) Set the **Allowed Remote IP Address** of the device sending the POS message.

● USB-to-RS-232 Connection

Configure the USB-to-RS-232 convertor port parameters, including the port serial number, baud rate, data bit, stop bit, parity, and flow ctrl.

USB-to-RS-232 Settings	
Serial Port Number	1
Baud Rate	4800
Data Bit	5
Stop Bit	1
Parity	None
Flow Ctrl	None
<input type="button" value="OK"/> <input type="button" value="Cancel"/>	

Figure 14-5 USB-to-RS-232 Settings

● RS-232 Connection

Connect the device and the POS machine via RS-232. The RS-232 settings can be configured in Menu>Configuration>RS-232. The Usage must be set to Transparent Channel.

● Multicast Connection

When connecting the device and the POS machine via Multicast protocol, set the multicast address and port.

● Sniff Connection

Connect the device and the POS machine via Sniff. Configure the source address and destination address settings.

Sniff Settings	
Enable Source Port F...	<input checked="" type="checkbox"/>
Source Address	18 . 16 . 1 . 1
Source Port	10020
Enable Destination A...	<input checked="" type="checkbox"/>
Enable Destination P...	<input checked="" type="checkbox"/>
Destination Address	20 . 18 . 1 . 24
Destination Port	10030
<input type="button" value="OK"/> <input type="button" value="Cancel"/>	

Figure 14-6 Sniff Settings

14.1.2 Configure POS Text Overlay

Step 1 Go to **System > POS**.

Step 2 Click **Channel Linkage and Display** tab.

Step 3 Select the linked channel to overlay the POS characters.

Step 4 Set the characters overlay for the enabled POS.

- Character encoding format: currently the Latin-1 format is available
- Overlay mode of the characters to display in scrolling or page mod
- Font size and font color
- Display time (sec) of the characters. The value ranges 5 -3600 sec.
- Timeout of POS event. The value ranges 5 -3600 sec. When the device has not received the POS message within the defined time, the transaction ends.

Step 5 In the **Privacy Settings**, set the POS privacy information to not display on the image, e.g., the card number, user name, etc.

Step 6 Result: The defined privacy information will be displayed using ***on the image instead.

Step 7 (optional) Check the checkbox to enable the **Overlay POS in Live View**. When this feature is enabled, the POS information is overlaid on the Live View image.

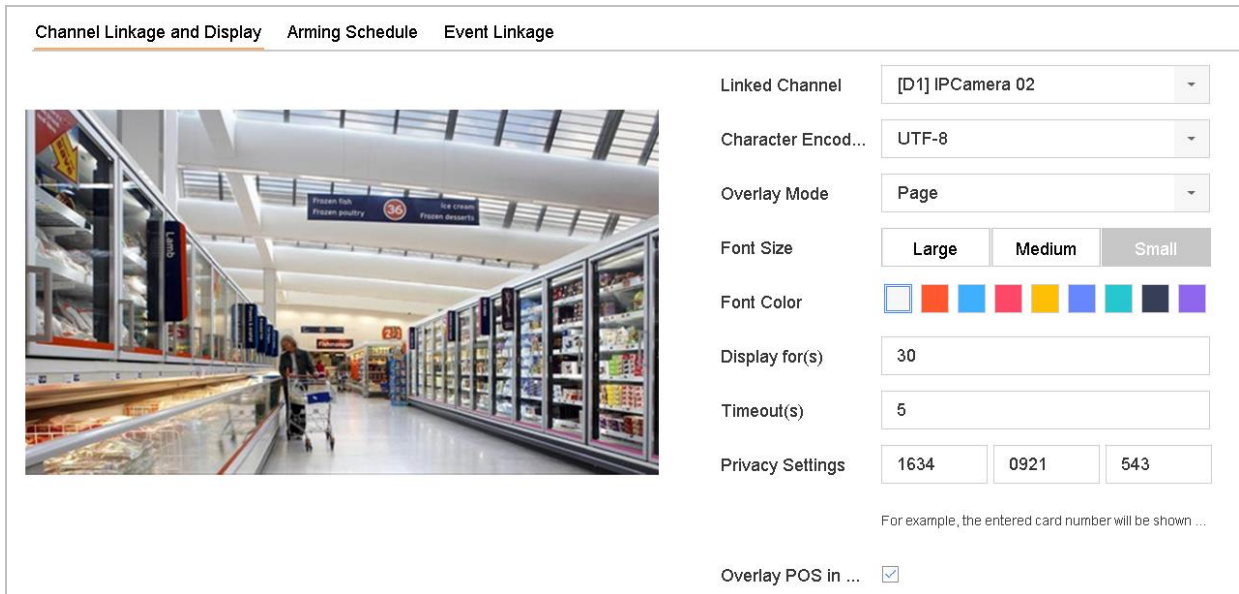

Figure 14-7 Overlay Character Settings

NOTE

Drag the frame to adjust the textbox size and position on POS settings interface preview screen.

Step 8 Click **Apply** to activate the settings.

14.2 Configure POS Alarm

Purpose

A POS event can trigger channels to start recording, or trigger full screen monitoring or an audio warning, notifying the surveillance center, send e-mail, etc.

Step 1 Go to **Storage > Recording Schedule**.

Step 2 Set the POS event's arming schedule.

Step 3 Go to **System > POS**.

Step 4 Click **Event Linkage** on the POS adding or editing interface.

Step 5 Select the normal linkage actions: full screen monitoring, audio warning, or send e-mail.

Step 6 Select one or more alarm output(s) to trigger.

Step 7 Select one or more channels to record or become full-screen monitoring when a POS alarm is triggered.

<input checked="" type="checkbox"/> Normal Linkage	<input type="checkbox"/> Trigger Alarm Output	<input type="checkbox"/> Trigger Channel
<input checked="" type="checkbox"/> Full Screen Monitoring	<input checked="" type="checkbox"/> Local->1	<input checked="" type="checkbox"/> D1
<input checked="" type="checkbox"/> Audible Warning	<input type="checkbox"/> Local->2	<input checked="" type="checkbox"/> D2
<input checked="" type="checkbox"/> Send Email	<input checked="" type="checkbox"/> Local->3	<input type="checkbox"/> D3
	<input type="checkbox"/> Local->4	<input type="checkbox"/> D4
	<input type="checkbox"/> 10.15.2.250:8000->1	

*Notice: please confirm the event output in "Live View" settings menu is the same with the real event output.

Figure 14-8 Set Trigger Cameras of POS

Step 8 Click **Apply** to save the settings.

Chapter 15 Network Settings

15.1 Configure TCP/IP Settings

Purpose

TCP/IP settings must be properly configured before you can operate the device will operate over a network.

15.1.1 Device with Dual Network Interface

Step 1 Go to **System > Network > TCP/IP**.

The screenshot shows the 'TCP/IP' configuration page with the following settings:

- Working Mode:** Net Fault-Tolerance
- Select NIC:** bond0
- NIC Type:** 10M/100M/1000M Self-adap
- Enable DHCP:**
- Enable Obtain DNS...:**
- IPv4 Address:** 10 . 15 . 2 . 107
- Preferred DNS Server:** [Empty field]
- IPv4 Subnet Mask:** 255 . 255 . 255 . 0
- Alternate DNS Server:** [Empty field]
- IPv4 Default Gateway:** 10 . 15 . 2 . 254
- MAC Address:** a4:14:37:aa:09:a3
- MTU(Bytes):** 1500
- Main NIC:** LAN1

An 'Apply' button is located at the bottom left of the configuration area.

Figure 15-1 TCP/IP Settings

Step 2 Select **Net-Fault Tolerance** or **Multi-Address Mode** under Working Mode.

- **Net-Fault Tolerance:** The two NIC cards use the same IP address, and you can select the main NIC to LAN1 or LAN2. In this way, in case of one NIC card failure, the device will automatically enable the other standby NIC card so as to ensure the normal running of the system.
- **Multi-Address Mode:** The parameters of the two NIC cards can be configured independently. You can select LAN1 or LAN2 under Select NIC for parameter settings. Select one NIC card as the default route. When the system connects with the extranet, the data will be forwarded through the default route.

Step 3 Configure other IP settings as needed.

 **NOTE**

- Check **Enable DHCP** to obtain IP settings automatically if a DHCP server is available on the network.
- Valid MTU value range is 500 to 9676.

Step 4 Click **Apply**.

15.1.2 Device with a Single Network Interface

Step 1 Go to **System > Network > TCP/IP**.

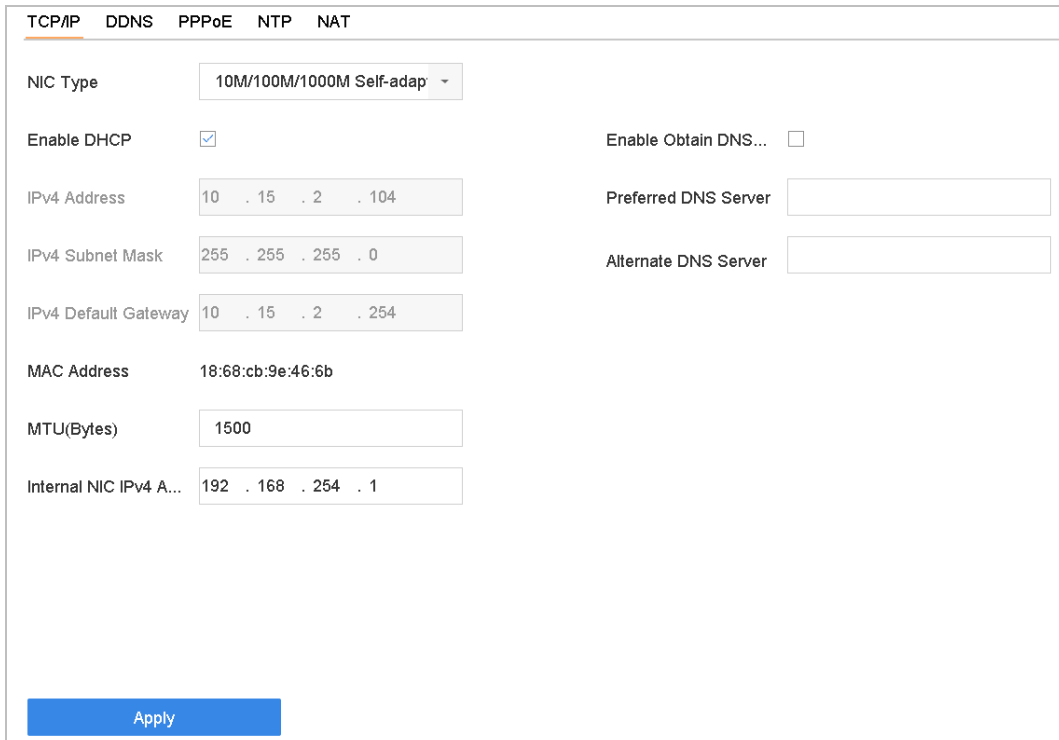

The screenshot shows the 'TCP/IP' settings page. At the top, there are tabs for 'TCP/IP', 'DDNS', 'PPPoE', 'NTP', and 'NAT'. The 'TCP/IP' tab is selected. Below the tabs, there are several configuration fields:

- NIC Type:** A dropdown menu showing '10M/100M/1000M Self-adap'.
- Enable DHCP:** A checkbox that is checked.
- Enable Obtain DNS...:** A checkbox that is unchecked.
- IPv4 Address:** A text input field containing '10 . 15 . 2 . 104'.
- Preferred DNS Server:** An empty text input field.
- IPv4 Subnet Mask:** A text input field containing '255 . 255 . 255 . 0'.
- Alternate DNS Server:** An empty text input field.
- IPv4 Default Gateway:** A text input field containing '10 . 15 . 2 . 254'.
- MAC Address:** A text input field containing '18:68:cb:9e:46:6b'.
- MTU(Bytes):** A text input field containing '1500'.
- Internal NIC IPv4 A...:** A text input field containing '192 . 168 . 254 . 1'.

At the bottom of the form, there is a blue button labeled 'Apply'.

Figure 15-2 TCP/IP Settings

Step 2 Configure network parameters as needed.

 **NOTE**

- Check **Enable DHCP** to obtain IP settings automatically if a DHCP server is available on the network.
- Valid MTU value range is 500 to 9676.

Step 3 Click **Apply**.

15.2 Configure Hik-Connect

Purpose

Hik-Connect provides the mobile phone application and the service platform page (www.hik-connect.com) to access and manage your connected encoder, which enables you to get a convenient remote access to the surveillance system.



The Hik-Connect can be enabled via operation on SADP software, GUI and Web browser. We introduce the operation steps on GUI in this section.

Step 1 Go to **Configuration > Network > Advanced Settings > Platform Access**.

Figure 15-3 Hik-Connect Settings

Step 2 Check **Enable** to activate the function. The Service Terms page pops up.

Figure 15-4 Service Terms

- 1) Create the verification code in the **Verification Code** text field.
- 2) Confirm the verification code.
- 3) Read **Terms of Service** and **Privacy Policy** before enabling the service.
- 4) Click **OK** to save the settings and return to the Hik-Connect page.

Enable

Platform Access Mode: Hik-Connect

Server Address: www.hik-connect.com Custom

Register Status: Offline

Verification Code: ●●●●●●

6 to 12 letters (a to z, A to Z) or numbers (0 to 9), case sensitive. You are recommended to use a combination of no less than 8 letters or numbers.

Create a verification code.

Save

Figure 15-5 Hik-Connect Settings

 NOTE

- Hik-Connect is disabled by default.
- The verification code is empty when the device leaves factory.
- The verification code must contain 6 to 12 letters or numbers and is case sensitive.
- Every time you enable Hik-Connect, the Service Terms page pops up and you should read Terms of Service and Privacy Policy before enabling it.

Step 3 If you want to customize the server, enable **Custom** and enter the **Server Address** in the text field.

Step 4 Click **Save**.

Step 5 After configuration, you can access and manage the device by your mobile phone or by the website (www.hik-connect.com).

- For the iOS users, please scan the QR code below to download the Hik-Connect application for the subsequent operations.



Figure 15-6 QR Code for iOS Users

- For the Android users, please scan the QR code below to download the Hik-Connect application for the subsequent operations. You must install *googleplay* on your Android mobile phone to skip to the address successfully.



Figure 15-7 QR Code for Android Users

 **NOTE**

Please refer to the help file on the official website (www.hik-connect.com) and the *Hik-Connect Mobile Client User Manual* for adding the device to Hik-Connect and more operation instructions.

15.3 Configure DDNS

Purpose

You can set Dynamic DNS service for network access. Different DDNS modes are available: **DynDNS**, **PeanutHull**, and **NO-IP**.

Before You Start

You must register the DynDNS, PeanutHull, or NO-IP services with your ISP before configuring DDNS settings.

Step 1 Go to **System > Network > TCP/IP > DDNS**.

Step 2 Check **Enable**.

Step 3 Select **DynDNS** under **DDNS Type**.

 **NOTE**

PeanutHull and NO-IP are also available under DDNS Type, and required information should be entered accordingly.

Step 4 Enter **Server Address** for **DynDNS** (i.e., members.dyndns.org).

Step 5 Under **Device Domain Name**, enter the domain name obtained from the DynDNS Website.

Step 6 Enter the **User Name** and **Password** registered in the DynDNS Website.

Figure 15-8 DDNS Settings

Step 7 Click **Apply**.

15.4 Configure PPPoE

If the device is connected to the Internet through PPPoE, you need to configure the user name and password accordingly under **System > Network > TCP/IP > PPPoE**.



Contact your Internet service provider for details about PPPoE service.

15.5 Configure NTP

Purpose

Connection to a network time protocol (NTP) server can be configured on your device to ensure the system's date and time accuracy.

Step 1 Go to **System > Network > TCP/IP > NTP**.

TCP/IP	DDNS	PPPoE	<u>NTP</u>	NAT
Enable			<input checked="" type="checkbox"/>	
Interval (min)			<input type="text" value="180"/>	
NTP Server			<input type="text" value="au.pool.ntp.org"/>	
NTP Port			<input type="text" value="123"/>	
<input type="button" value="Apply"/>				

Figure 15-9 NTP Settings

Step 2 Check **Enable**.

Step 3 Configure NTP settings as need.

- **Interval (min)**: Time interval between two time synchronization with NTP server
- **NTP Server**: IP address of the NTP server
- **NTP Port**: Port of the NTP server

Step 4 Click **Apply**.

15.6 Configure SNMP

Purpose

You can configure SNMP settings to get device status and parameter information.

Before You Start

Download the SNMP software to receive device information via the SNMP port. By setting the trap address and port, the device is allowed to send alarm events and exception messages to the surveillance center.

Step 1 Go to **System > Network > Advanced > SNMP**.

Figure 15-10 SNMP Settings

Step 2 Check **Enable**. A message will pop up to notify about a possible security risk. Click **Yes** to continue.

Step 3 Configure the SNMP settings as needed.

- **Trap Address:** SNMP host IP address.
- **Trap Port:** Port of the SNMP host.

Step 4 Click **Apply**.

15.7 Configure Email

Purpose

The system can be configured to send an e-mail notification to all designated users when a specified event occurs such as when an alarm or motion event is detected, the administrator password is changed, etc.

Before You Start

The device must be connected to a local area network (LAN) that contains an SMTP mail server. The network must also be connected to either an intranet or the Internet depending on the location of the e-mail accounts to which you want to send notifications.

Step 1 Go to **System > Network > Advanced > Email**.

Figure 15-11 E-mail Settings

Step 2 Configure the following e-mail settings.

- **Enable Server Authentication:** Check to enable the function if the SMTP server requires user authentication, and enter the user name and password accordingly.
- **SMTP Server:** IP address of SMTP Server or host name (e.g., smtp.263xmail.com).
- **SMTP Port:** The default TCP/IP port used for SMTP is 25.
- **Enable SSL/TLS:** Check to enable SSL/TLS if required by the SMTP server.
- **Sender:** The sender's name.
- **Sender's Address:** The sender's Address.
- **Select Receivers:** Select the receiver. Up to 3 receivers can be configured.
- **Receiver:** The receiver's name.
- **Receiver's Address:** The e-mail address of the user to be notified.
- **Enable Attached Picture:** Check to send e-mail with attached alarm images. The interval is the time between sending two subsequent alarm images.

Step 3 Click **Apply**.

Step 4 (Optional) Click **Test** to send a test e-mail.

15.8 Configure Ports

You can configure different types of ports to enable relevant functions.

Go to **System > Network > Advanced > More Settings** and configure port settings as needed.

- **Alarm Host IP/Port:** With a remote alarm host configured, the device will send the alarm event or exception message to the host when an alarm is triggered. The remote alarm host must have the client management system (CMS) software installed.

The **Alarm Host IP** refers to the IP address of the remote PC on which the CMS software (e.g., iVMS-4200) is installed, and the **Alarm Host Port** (7200 by default) must be the same as the alarm monitoring port configured in the software.

- **Server Port:** Server port (8000 by default) should be configured for remote client software access and its valid range is 2000 to 65535.
- **HTTP Port:** HTTP port (80 by default) should be configured for remote Web browser access.
- **Multicast IP:** Multicast can be configured to enable Live View for cameras that exceed the maximum number allowed through network. A multicast IP address covers Class-D IP ranging from 224.0.0.0 to 239.255.255.255 and it is recommended to use an IP address ranging from 239.252.0.0 to 239.255.255.255.

When adding a device to the CMS software, the multicast address must be the same as that of the device.

- **RTSP Port:** RTSP (Real Time Streaming Protocol) is a network control protocol designed to control streaming media servers. The port is 554 by default.

SNMP	Email	More Settings
		Alarm Host IP <input type="text"/>
		Alarm Host Port <input type="text" value="0"/>
		Server Port <input type="text" value="8000"/>
		HTTP Port <input type="text" value="80"/>
		Multicast IP <input type="text"/>
		RTSP Port <input type="text" value="554"/>
<input type="button" value="Apply"/>		

Figure 15-12 Port Settings

Chapter 16 Hot Spare Device Backup

Purpose

The device can form an N+1 hot spare system. The system consists of several working devices and a hot spare device; when the working device fails, the hot spare device switches into operation, thus increasing the reliability of the system. Contact your dealer for details of models that support the hot spare function.

A bidirectional connection shown in the figure below is required to be built between the hot spare device and each working device.

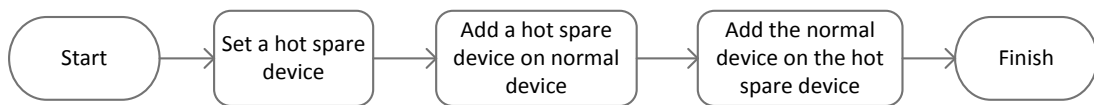

Figure 16-1 Building a Hot Spare System

Before You Start

At least 2 devices must be online.

16.2 Set Hot Spare Device

Purpose

Hot spare devices takes over working device tasks when working devices fail.

Step 1 Go to **System > Hot Spare**.

Step 2 Set the **Work Mode** to **Hot Spare Mode**.

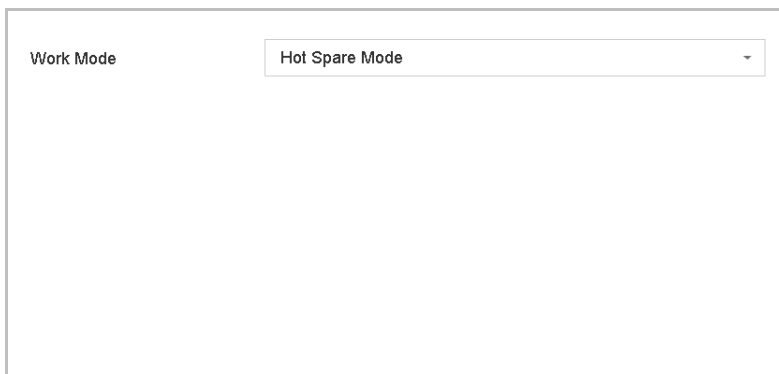

Figure 16-2 Hot Spare

Step 3 Click **Apply**.

Step 4 Click **Yes** in the popup attention box to reboot the device.

 **NOTE**

- The camera connection will be disabled when the device works in hot spare mode.
- It is highly recommended to restore the device defaults after switching the working mode of the hot spare device to normal mode to ensure the normal operation afterwards.

16.3 Set Working Device

Step 1 Go to **System > Hot Spare**.

Step 2 Set the **Work Mode** to **Normal Mode**.

Step 3 Check **Enable**.

Step 4 Enter the IP address, user name, and admin password of the hot spare device.

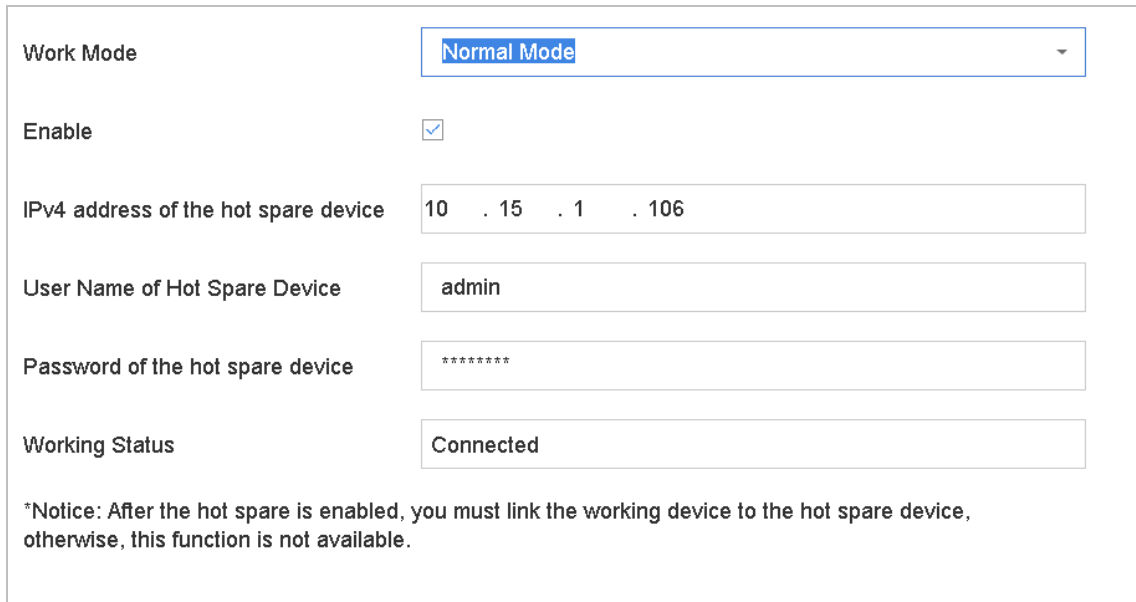

Work Mode	Normal Mode
Enable	<input checked="" type="checkbox"/>
IPv4 address of the hot spare device	10 . 15 . 1 . 106
User Name of Hot Spare Device	admin
Password of the hot spare device	*****
Working Status	Connected

*Notice: After the hot spare is enabled, you must link the working device to the hot spare device, otherwise, this function is not available.

Figure 16-3 Hot Spare

Step 5 Click **Apply**.

16.4 Manage Hot Spare System

Step 1 Go to **System > Hot Spare** in the hot spare device.

Step 2 Check working devices on the device list and click **Add** to link the working device to the hot spare device.

 **NOTE**

A hot spare device can connect up to 32 working devices.

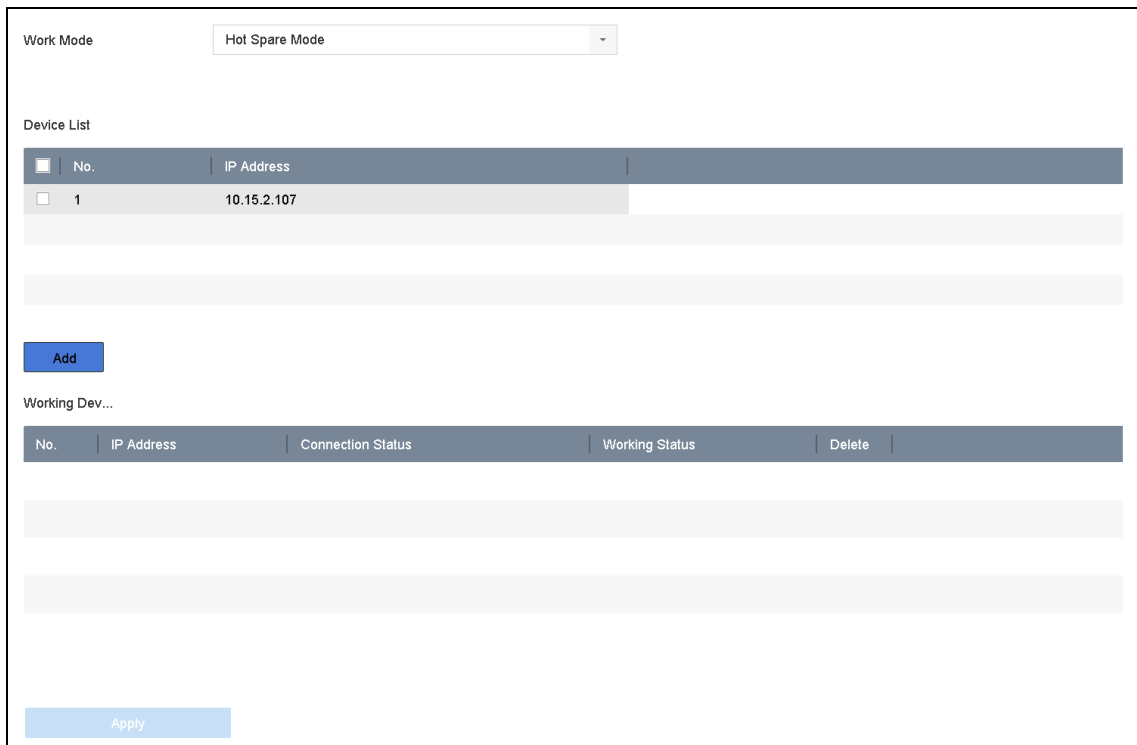

Figure 16-4 Add Working Device

Table 16-1 Working Status Description

Working Status	Description
No record	The working device works properly.
Backing up	If the working device goes offline, the hot spare device will record the video of the IP camera connected to the working device for backup The record back up functions for 1 working device at a time.
Synchronizing	When the working device comes back online, the lost video files will be restored by the record synchronization function. The record synchronization function can be enabled for 1 working device at a time.

Chapter 17 User Management and Security

17.1 Manage User Accounts

Purpose

The *Administrator* user name is *admin* and the password is set when you start the device for the first time. The *Administrator* has the permission to add and delete users and configure user parameters.

17.1.1 Add a User

Step 1 Go to **System > User**.

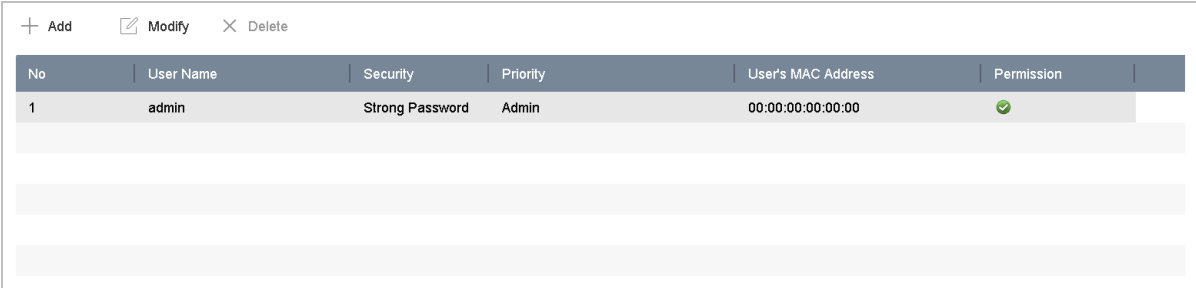

No	User Name	Security	Priority	User's MAC Address	Permission
1	admin	Strong Password	Admin	00:00:00:00:00:00	✓

Figure 17-1 User Management Interface

Step 2 Click **Add** to enter the operation permission interface.

Step 3 Input the admin password and click **OK**.

Step 4 In the Add User interface, enter the information for a new user, including **User Name**, **Password**, **Confirm** (password), **User Level** (Operator/Guest), and **User's MAC Address**.

Figure 17-2 Add User

 **WARNING**

Strong Password Recommended—We highly recommend you create a strong password of your own choosing (using a minimum of 8 characters, including at least three of the following categories: upper case letters, lower case letters, numbers, and special characters) in order to increase the security of your product. We also recommend that you reset your password regularly. Especially in the high security systems, resetting the password monthly or weekly can better protect your product.

- **User Level:** Set the user level to Operator or Guest. Different user levels have different operating permission.
 - Operator:** An *Operator* user level has Two-way Audio permission in Remote Configuration and all operating permissions in Camera Configuration by default.
 - Guest:** The Guest user has no permission of Two-way Audio in Remote Configuration and only has the local/remote playback in the Camera Configuration by default.
- **User's MAC Address:** The MAC address of the remote PC that logs onto the device. If it is configured and enabled, it allows only the remote user with this MAC address to access the device.

Step 5 Click **OK** to finish adding the new user account.

Step 6 In the User Management interface, the added new user is displayed on the list.

No	User Name	Security	Priority	User's MAC Address	Permission
1	admin	Strong Password	Admin	00:00:00:00:00:00	✓
2	A01	Strong Password	Operator	00:00:00:00:00:00	✓
3	A02	Strong Password	Operator	00:00:00:00:00:00	✓

Figure 17-3 User List

17.1.2 Edit the Admin User

You can modify the admin user account's password and unlock pattern.

Step 1 Go to **System > User**.

Step 2 Select the admin user from the list and click **Modify**.

Edit User ✕

User Name admin

Password Discard C...

Confirm

Note: Valid password range [8-16]. You can use ...

Password Str... ▬ ▬ ▬

User's MAC A...

Unlock Pattern Enable Unlock Pattern ⚙

GUID File Export ?

Security Ques... ⚙

OK
Cancel

Figure 17-4 Edit User (Admin)

Step 3 Edit the admin user information as desired, including a new admin password (strong password is required) and MAC address.

Step 4 Edit the unlock pattern for the admin user account.

- 1) Check **Enable Unlock Pattern** to enable the use of an unlock pattern when logging in to the device.
- 2) Use the mouse to draw a pattern among the 9 dots on the screen, and release the mouse when the pattern is done.



Refer to Chapter 2.2 Step 2 for detailed instructions.

Step 5 Click  of **Export GUID** to enter the reset password interface to export the GUID file for the admin user account.

Step 6 When the admin password is changed, export the new GUID to the connected USB flash disk in the Import/Export interface for the future password resetting.

Step 7 Set the **security questions**.

Step 8 Click **OK** to save the settings.

Step 9 For an **Operator** or **Guest** user account, click  on the user management interface to edit the permissions.

17.1.3 Edit an Operator/Guest User

You can edit the user information, including user name, password, permission level, and MAC address. Check **Change Password** to change the password, and input the new password in the text field of **Password** and **Confirm**. A strong password is recommended.

Step 1 Go to **System > User**.

Step 2 Select a user from the list and click **Modify**.

Figure 17-5 Edit User (Operator/Guest)

Step 3 Edit the user information as desired, including the new password (strong password is required) and MAC address.

17.1.4 Delete a User

The admin user account has the permission to delete an operator/guest user account.

Step 1 Go to **System > User**.

Step 2 Select a user from the list.

Step 3 Click **Delete** to delete the selected user account.

17.2 Manage User Permissions

17.2.1 Set User Permissions

For an added user, you can assign the different permissions, including local and remote operation of the device.

Step 1 Go to **System > User**.

Step 2 Select a user from the list, and then click  to enter the permission settings interface.

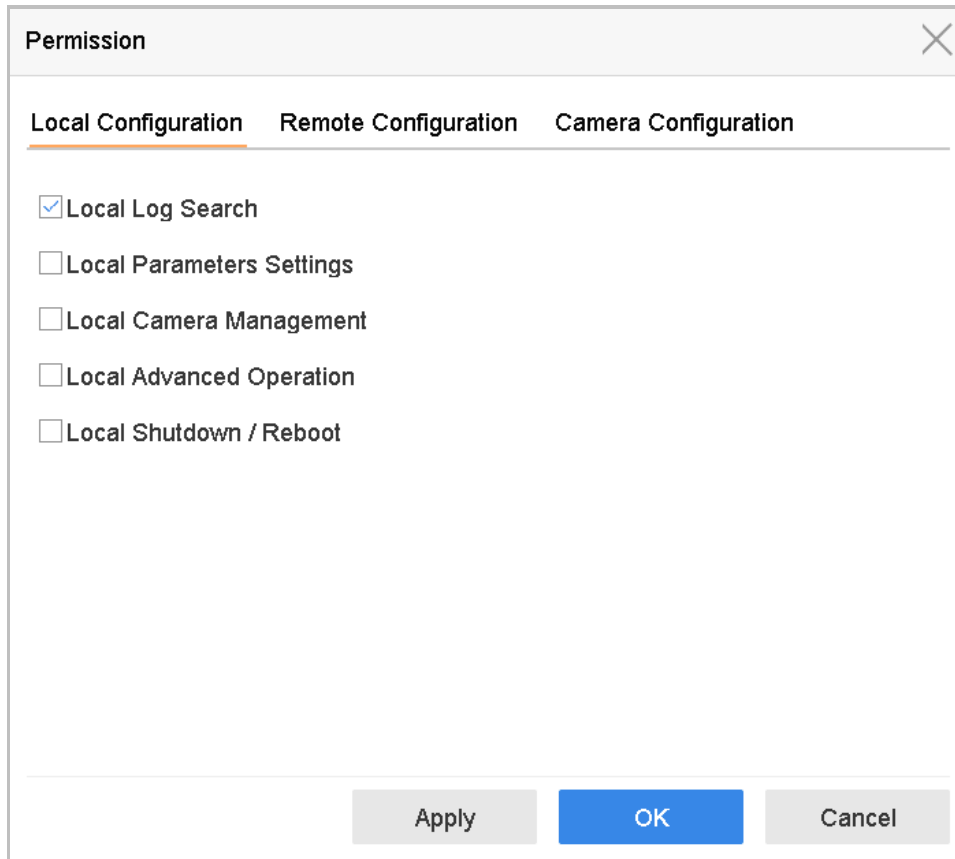

Figure 17-6 User Permission Settings Interface

Step 3 Set the user's operating permissions for Local Configuration, Remote Configuration, and Camera Configuration for the user.

● **Local Configuration**

- **Local Log Search:** Searching and viewing logs and system information of device.
- **Local Parameters Settings:** Configuring parameters, restoring factory default parameters, and importing/exporting configuration files.
- **Local Camera Management:** Adding, deleting, and editing of IP cameras.
- **Local Advanced Operation:** Operating HDD management (initializing HDD, setting HDD property), upgrading system firmware, clearing I/O alarm output.
- **Local Shutdown Reboot:** Shutting down or rebooting the device.

● **Remote Configuration**

- **Remote Log Search:** Remotely viewing logs that are saved on the device.
- **Remote Parameters Settings:** Remotely configuring parameters, restoring factory default parameters, and importing/exporting configuration files.
- **Remote Camera Management:** Remote adding, deleting, and editing of the IP cameras.
- **Remote Serial Port Control:** Configuring settings for RS-232 and RS-485 port settings.
- **Remote Video Output Control:** Sending remote button control signals.

- **Two-Way Audio:** Operating the two-way radio between the remote client and the device.
- **Remote Alarm Control:** Remotely arming (notify alarm and exception message to the remote client) and controlling the alarm output.
- **Remote Advanced Operation:** Remotely operating HDD management (initializing HDD, setting HDD property), upgrading system firmware, clearing I/O alarm output.
- **Remote Shutdown/Reboot:** Remotely shutting down or rebooting the device.
- **Camera Configuration**
 - **Remote Live View:** Remotely viewing live video of the selected camera(s).
 - **Local Manual Operation:** Locally starting/stopping manual recording and alarm output of the selected camera(s).
 - **Remote Manual Operation:** Remotely starting/stopping manual recording and alarm output of the selected camera(s). **Local Playback:** Locally playing back recorded files of the selected camera(s).
 - **Remote Playback:** Remotely playing back recorded files of the selected camera(s).
 - **Local PTZ Control:** Locally controlling PTZ movement of the selected camera(s).
 - **Remote PTZ Control:** Remotely controlling PTZ movement of the selected camera(s).
 - **Local Video Export:** Locally exporting recorded files of the selected camera(s).
 - **Local Live View:** View live video of the selected camera(s) in local.

Step 4 Click **OK** to save the settings.



Only the admin user account has the permission to restore factory default parameters.

17.2.2 Set Local Live View Permission for Non-Admin Users

The admin user can assign to normal users (Operator or Guest) the live view permission for specific cameras.

Step 1 Go to **System > User**.

Step 2 Click  of the admin user.

Step 3 Input admin password and click **OK**.

Step 4 Select cameras that a non-admin user can view locally and click **OK**.

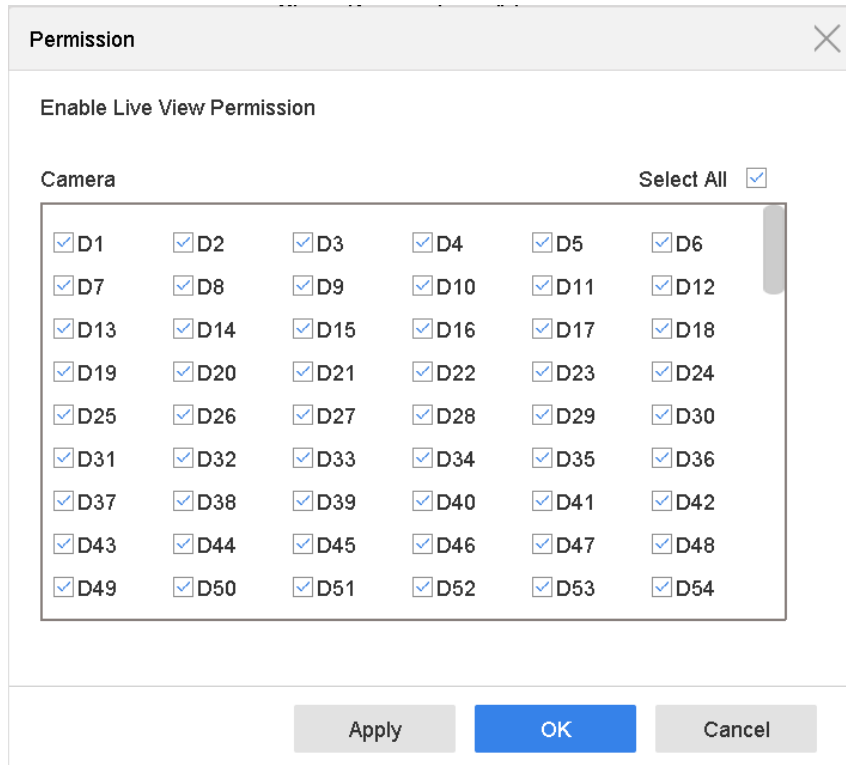



Figure 17-7 Set Live View Permissions

Step 5 Click  of non-admin user.

Step 6 Click the **Camera Configuration** tab.

Step 7 Select Camera Permission as **Local Live View**.

Step 8 Select cameras to display in Live View.

Step 9 Click **OK**.

17.2.3 Set Live View Permission on Lock Screen

The admin user can set live view permission for specific cameras in the screen lock status of device.

Step 1 Go to **System > User**.

Step 2 Click **Live View Permission on Lock Screen**.

Step 3 Input admin password and click **Next**.

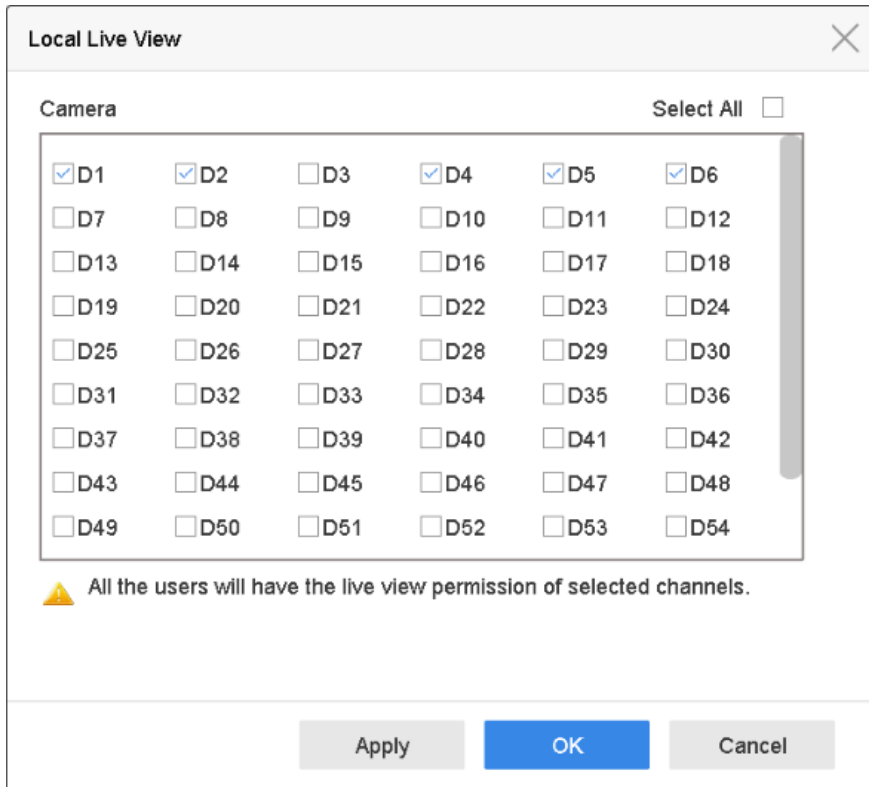

Figure 17-8 Set Live View Permissions on Lock Screen

Step 4 Set the permissions.

- Select the camera (s) to allow live view when the current user account is in logout status.
- Deselect the camera (s) to forbidden the camera (s) being viewed when the current user account is in logout status.

Step 5 Click **OK**.

 **NOTE**

- The *admin* user can set this permission for user accounts.
- When the normal user (Operator or Guest) has no local live view permission for specific camera (s) (refer to 17.2.2 Set Local Live View Permission for Non-Admin Users), the live view permission for such camera (s) on lock screen status cannot be configured (live view not allowed by default).

17.3 Configure Password Security

17.3.1 Export GUID File

The GUID file may help you to reset password when you forget password.

Step 1 Select to export GUID file when you are activating the device, or editing the admin user account.

Step 2 Insert the U flash disk to your device, and export the GUID file to the U flash disk.

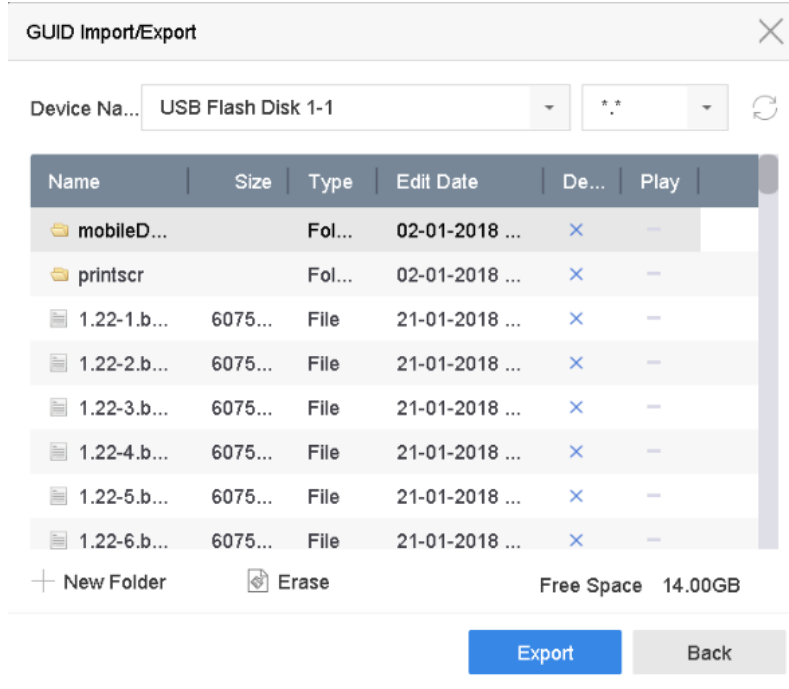

Figure 17-9 Export GUID File

NOTE

Please keep your GUID file properly for future password resetting.

17.3.2 Configure Security Questions

The security question configuration may help you to reset password when you forget your password or encounter security issues.

Step 1 Click **Security Question Configuration** when you are activating the device, or editing the admin user account.

Step 2 Select three security questions from the drop-down list and input the answers.

Step 3 Click **OK**.

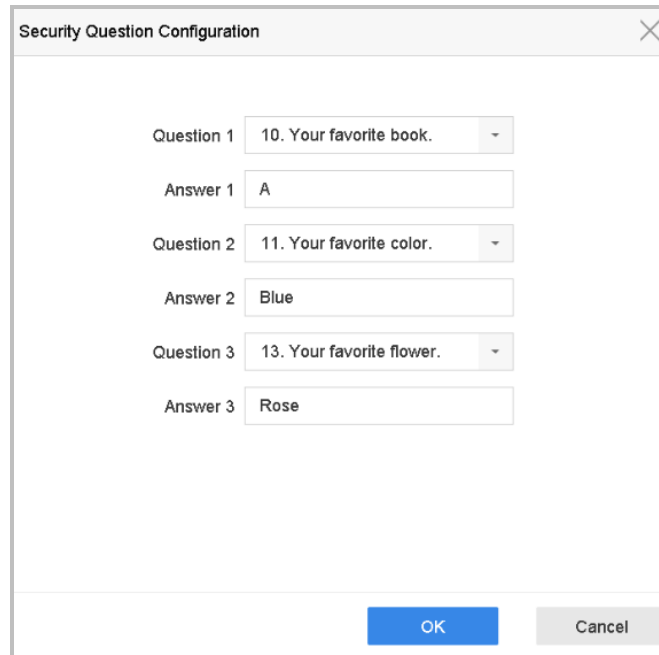

Figure 17-10 Configure Security Questions

17.4 Reset Password

When you forget the admin password, you can reset the password by importing the GUID file or by answering security questions.

17.4.1 Reset Password by GUID

Before You Start

The GUID file must be exported and saved in the local U flash disk after you have activated the device or edited the admin user account. (Refer to Chapter 17.3.1 Export GUID File).

Step 1 On the user login interface, click **Forgot Password**.

Step 2 Select the password resetting type to **Verify by GUID**.



NOTE

Please insert the U flash disk stored with the GUID file to the NVR before resetting password.

Step 3 Select the GUID file from the U flash disk and click **Import** to import the file to the device.



NOTE

If you have imported the wrong GUID file for 7 times, you will be not allowed to reset the password for 30 minutes.

Step 4 After the GUID file is successfully imported, enter the reset password interface to set the new admin password.

Step 5 Click **OK** to set the new password. You can export the new GUID file to the U flash disk for future password resetting.

 **NOTE**

When the new password is set, the original GUID file will be invalid. The new GUID file should be exported for future password resetting. You can also enter the User>User Management interface to edit the admin user and export the GUID file.

17.4.2 Reset Password by Security Questions

Before You Start

You have configured the security questions when you activate the device or edit the admin user account. (Refer to Chapter 17.3.2 Configure Security Questions).

Step 1 On the user login interface, click **Forgot Password**.

Step 2 Select the password resetting type to **Verify by Security Question**.

Step 3 Input the correct answers of the three security questions.

Step 4 Click **OK**.

 **NOTE**

If the answers mismatch, the verification is failed.

Step 5 Create the new admin password on the **Reset Password** interface.

Chapter 18 System Service Maintenance

18.1 Storage Device Maintenance

18.1.1 Configure Disk Clone

Purpose

Select the HDDs to clone to the eSATA HDD.

Before You Start

Connect an eSATA disk to the device.

Step 1 Go to **Maintenance > HDD Operation > HDD Clone**.

Clone Source						
Label	Capacity	Status	Property	Type	Free Space	Group
<input type="checkbox"/> 1	1863.02GB	Normal	R/W	Local	1858.00GB	1
<input type="checkbox"/> 2	2794.52GB	Normal	R/W	Local	2794.00GB	1
<input type="checkbox"/> 5	1863.02GB	Normal	R/W	Local	1862.00GB	1
<input type="checkbox"/> 9	2794.52GB	Normal	R/W	Local	2794.00GB	1
<input type="checkbox"/> 10	1863.02GB	Normal	R/W	Local	1862.00GB	1

Clone Destination

eSATA:

Capacity:

Figure 18-1 HDD Clone

Step 2 Check the HDD to clone. The capacity of the selected HDD must match the capacity of the clone destination.

Step 3 Click **Clone**.

Step 4 Click **Yes** on the popup message box to create the clone.

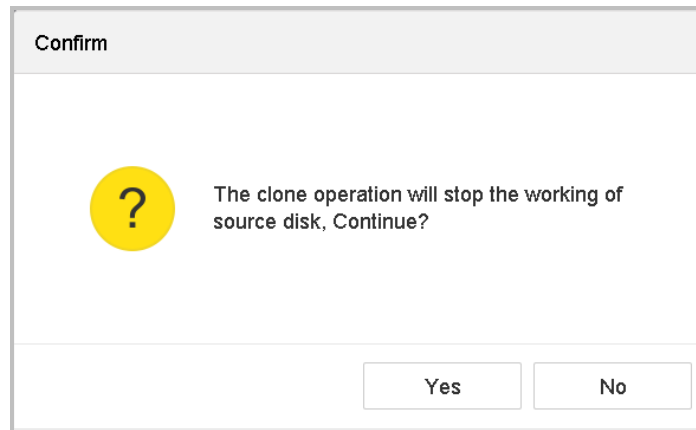

Figure 18-2 Message Box

18.1.2 S.M.A.R.T. Detection

Purpose

HDD detection functions such as the adopting of the S.M.A.R.T. and the Bad Sector Detection techniques. S.M.A.R.T. (Self-Monitoring, Analysis and Reporting Technology) are HDD monitoring systems to detect various reliability indicators in the hopes of anticipating failures.

Step 1 Go to **Maintenance > HDD Operation > S.M.A.R.T.**

Step 2 Select the HDD to view its S.M.A.R.T. information list.

Step 3 Select the self-test types as **Short Test**, **Expanded Test**, or the **Conveyance Test**.

Step 4 Click **Self-Test** to start the S.M.A.R.T. HDD self-evaluation.

Step 5 The related S.M.R.T. information of the S.M.A.R.T. is shown, and you can check the HDD status.

Continue to use this disk when self-evaluation is failed.

HDD No.

Self-Test Type

Temperature... Self-Evaluation

Working Time... All-Evaluation

S.M.A.R.T Infor

ID	Attribute Name	Status	Flags	Threshold	Value	Worst	Raw Value
0x1	Raw Read Error R...	OK	2f	51	200	200	8
0x3	Spin Up Time	OK	27	21	113	107	7316
0x4	Start/Stop Count	OK	32	0	98	98	2657
0x5	Reallocated Sector...	OK	33	140	200	200	0
0x7	Seek Error Rate	OK	2e	0	200	200	0
0x9	Power-on Hours C...	OK	32	0	88	88	9369
0xa	Spin Up Retry Count	OK	32	0	100	100	0
0xb	Calibration Retry C...	OK	32	0	100	100	0

Figure 18-3 S.M.A.R.T. Settings Interface

 **NOTE**

To use the HDD even when the S.M.A.R.T. checking has failed, check **Continue to use the disk when self-evaluation is failed** checkbox.

18.1.3 Bad Sector Detection

Step 1 Go to **Maintenance > HDD Operation > Bad Sector Detection**.

Step 2 Select the HDD No. you want to configure in the dropdown list.

Step 3 Select **All Detection** or **Key Area Detection** as the detection type.

Step 4 Click the **Self-Test** button to start the detection.

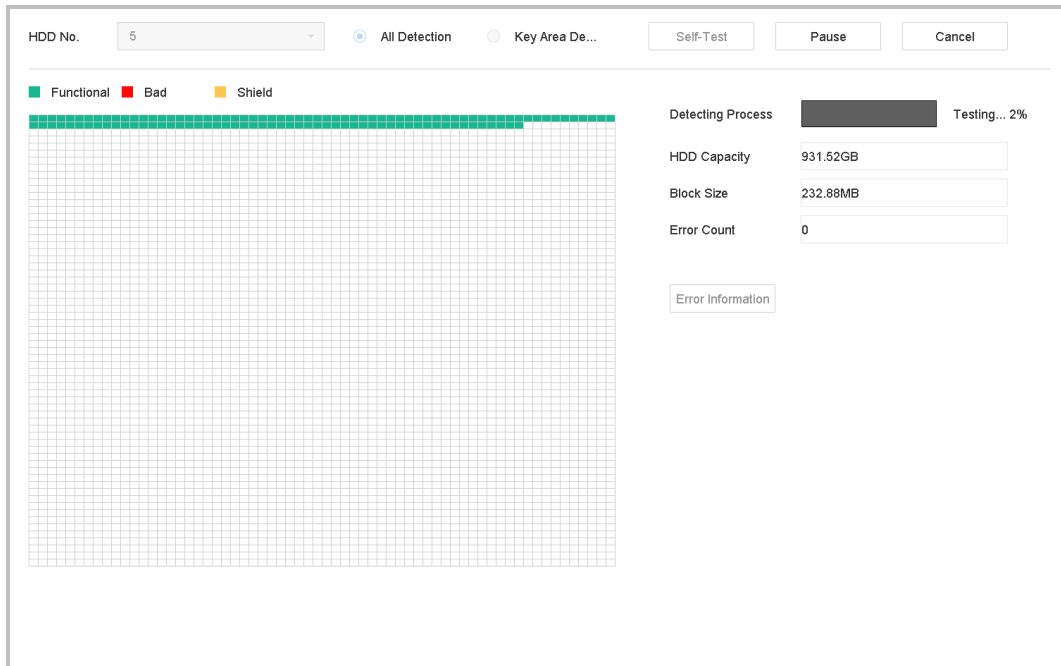

Figure 18-4 Bad Sector Detection

- You can pause/resume or cancel the detection.
- After testing has been completed, you can click **Error information** to see the detailed damage information.

18.1.4 HDD Health Detection

Purpose

You can view the health status of a 4 TB to 8 TB Seagate HDD that generated after October 1, 2017. Use this function to help troubleshoot HDD problems. Health Detection shows a more detailed HDD status than the S.M.A.R.T. function.

Step 1 Go to **Maintenance > HDD Operation > Health Detection**.

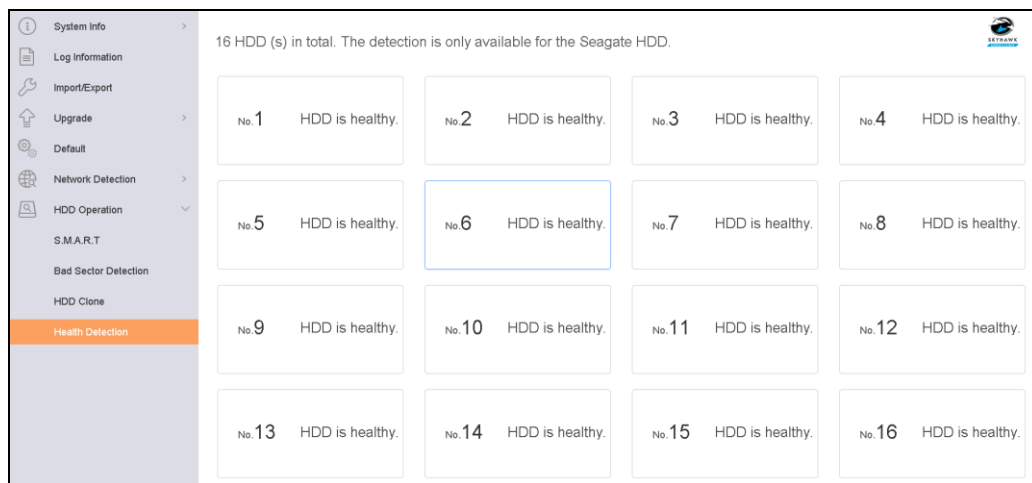

Figure 18-5 Health Detection

Step 2 Click an HDD to view details.

18.2 Search and Export Log Files

Purpose

The device operation, alarm, exception, and information can be stored in log files, which can be viewed and exported at any time.

18.2.1 Search the Log Files

Step 1 Go to **Maintenance > Log Information**.

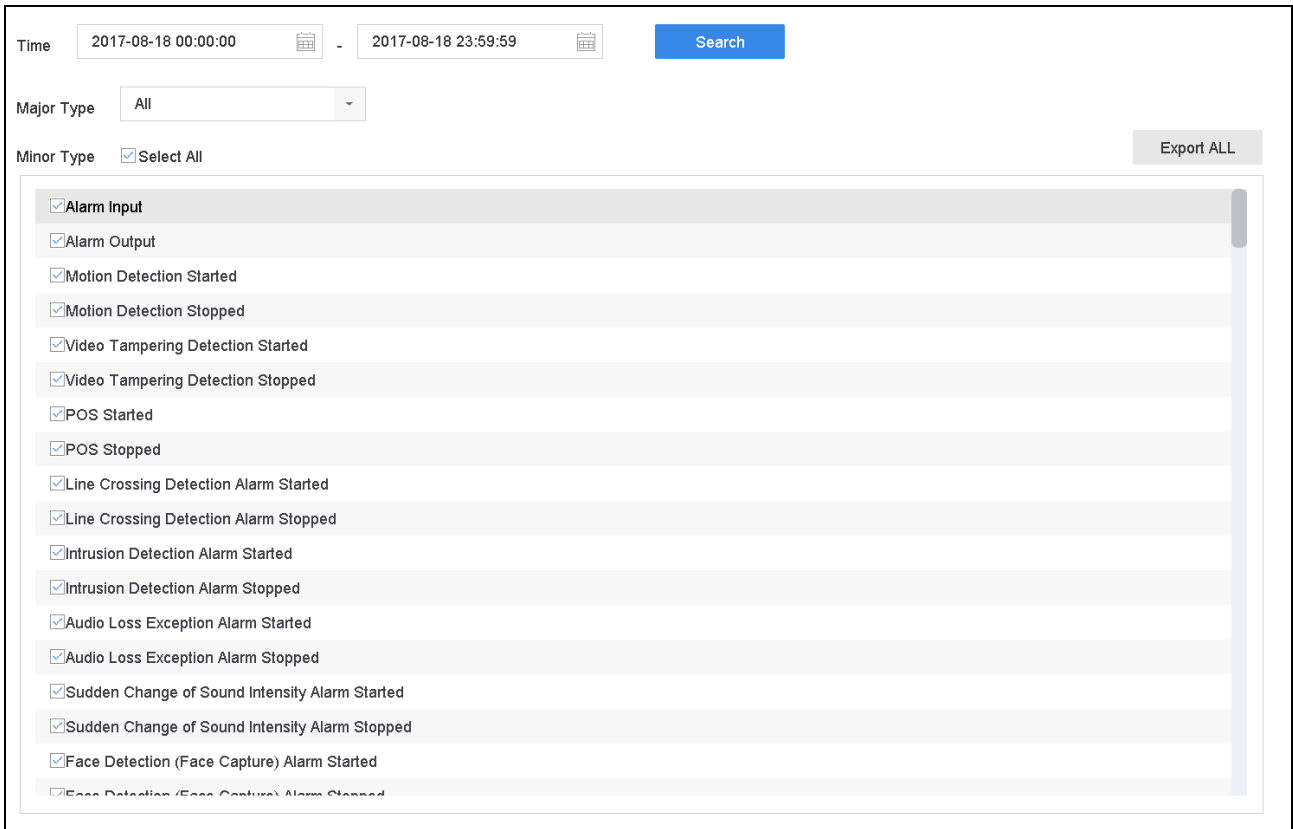

Figure 18-6 Log Search Interface

Step 2 Set the log search conditions, including the time, major type and minor type.

Step 3 Click **Search** to start searching the log files.

Step 4 The matched log files will be displayed on the list, as shown below.

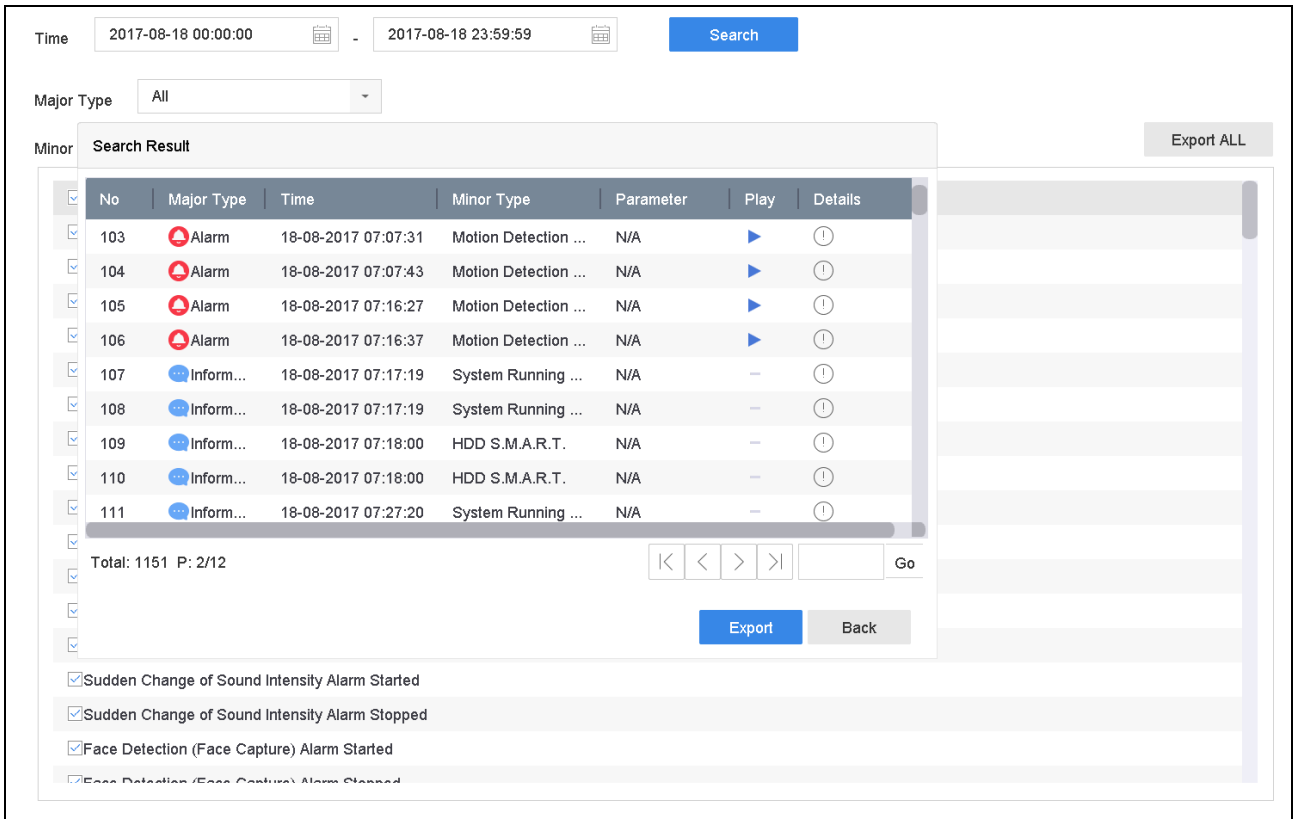

Figure 18-7 Log Search Results

NOTE

Up to 2,000 log files can be displayed each time.

Step 5 Related Operation:

- Click ⓘ or double-click it to view detailed information.
- Click ▶ to view the related video file.

18.2.2 Export the Log Files

Before You Start

Connect a storage device to the NVR.

Step 1 Search the log files. Refer to Chapter 18.2.1 Search the Log Files.

Step 2 Select the log files you want to export, and click **Export** or click **Export ALL** on the Log Search interface to export all the system logs to the storage device.

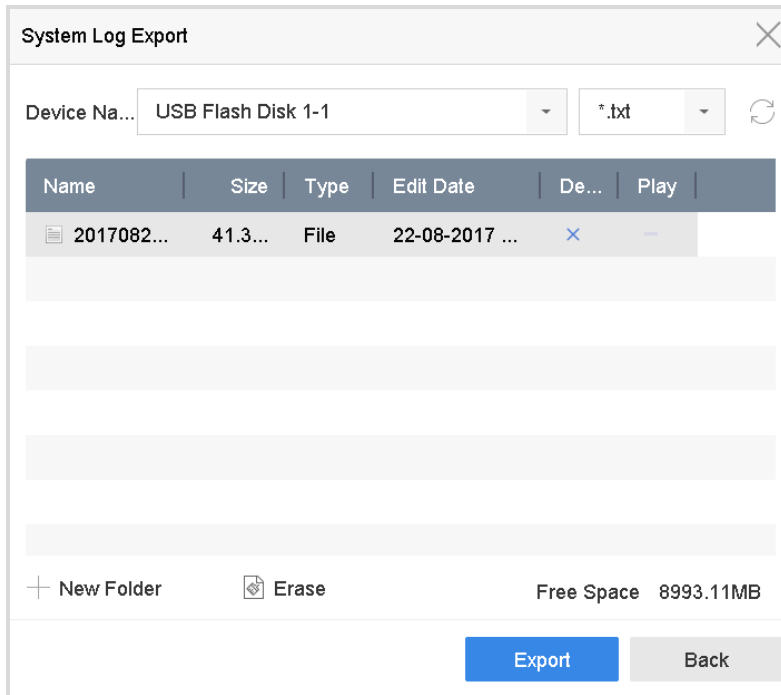

Figure 18-6 Export Log Files

Step 3 On the Export interface, select the storage device from **Device Name**.

Step 4 Select the format of the log files to be exported. Up to 15 formats are selectable.

Step 5 Click **Export** to export the log files to the selected storage device.

- Click the **New Folder** button to create a new folder in the storage device.
- Click the **Format** button to format the storage device before exporting the log(s).

18.3 Import/Export IP Camera Configuration Files

Purpose

The IP camera information, including the IP address, manage port, password of admin, etc., can be saved in Microsoft Excel format and backed up to the local device. The exported file can be edited on a PC, including adding or deleting the content, and copying the setting to other devices by importing the Excel file to it.

Before You Start

When importing the configuration file, connect the storage device that contains the configuration file to the NVR.

Step 1 Go to **Camera > IP Camera Import/Export**.

Step 2 Click the **IP Camera Import/Export** tab, and the detected external device contents appear.

Step 3 Export or import the IP camera configuration files.

- Click **Export** to export the configuration files to the selected local backup device.
- To import a configuration file, select the file from the selected backup device and click **Import**.

 **NOTE**

After the importing process is completed, you must reboot the device to activate the settings.

18.4 Import/Export Device Configuration Files

Purpose

The device configuration files can be exported to a local device for backup; and the configuration files of one device can be imported to multiple devices if they are to be configured with the same parameters.

Before You Start

Connect a storage device to your device. To import the configuration file, the storage device must contain the file.

Step 1 Go to **Maintenance > Import/Export**.

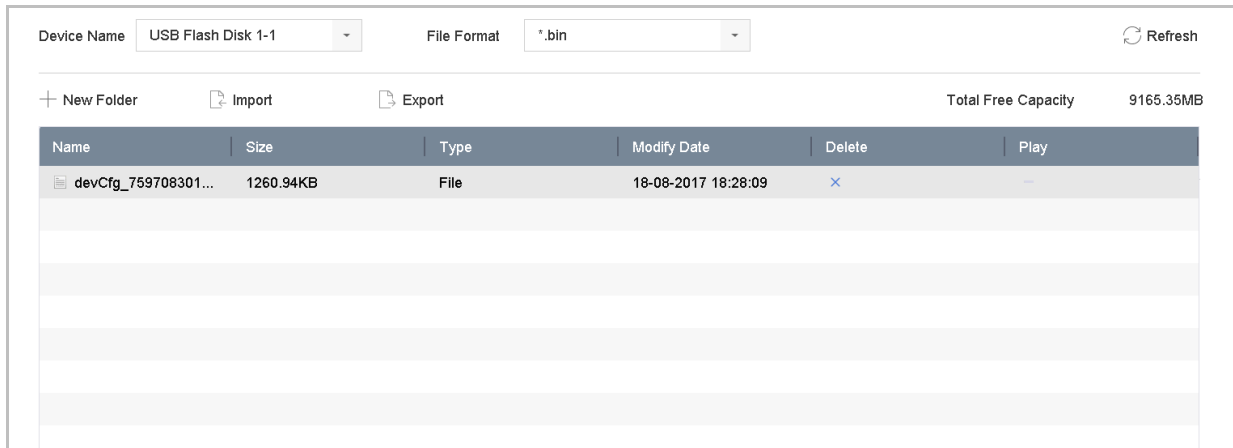

Figure 18-7 Import/Export Config File

Step 2 Export or import the device configuration files.

- Click **Export** to export configuration files to the selected local backup device.
- To import a configuration file, select the file from the selected backup device and click the **Import**.

NOTE

After having finished importing configuration files, the device will reboot automatically.

18.5 Configure System Services

18.5.1 Control4 Protocol

The Control4 protocol enables you to search the Hikvision devices via SDDP, get the basic network parameters, device information, or access some device operations.

Step 1 Go to **Menu > Maintenance > System Service > More Settings > Control4**.

Step 2 Check the checkbox of **Enable SDDP** or **Enable CGI**.

Step 3 Click **Apply**.

18.5.2 I-VIEW-NOW UPNP Reporting

The I-VIEW-NOW UPNP Reporting service allows the system to automatically send the device network parameters to authorized receivers by e-mail.

Step 1 Go to **Menu > Maintenance > System Service > More Settings > I-VIEW-NOW UPNP Reporting**.

Step 2 Check the checkbox of **I-VIEW-NOW UPNP Reporting**.

Step 3 Click **Apply**.

18.6 Configure Stream Encryption

The stream encryption enables to encrypt the streams for live view, playback, download, backup, etc.

Step 1 Go to **Menu > Maintenance > System Service > Stream Encryption**.

Step 2 Check **Enable Stream Encryption**.

Step 3 Create the encryption password.



NOTE

The stream encryption password is synchronized with the Hik-Connect service verification code. After enabling the encryption code, the Hik-Connect stream will be forcedly encrypted. Make sure the Hik-Connect service supports the stream encryption as well.

18.7 Upgrade the System

Purpose

The firmware on your device can be upgraded with a local backup device or remote FTP server.

18.7.1 Upgrade with a Local Backup Device

Before You Start

Connect your device to a local storage device that contains the firmware update file.

Step 1 Go to **Maintenance>Upgrade**.

Step 2 Click the **Local Upgrade** tab to enter the local upgrade interface.

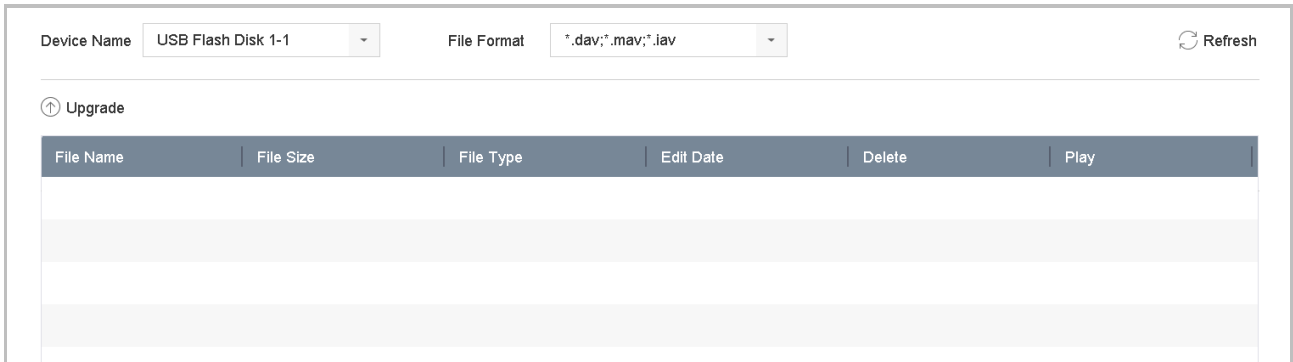

Figure 18-8 Local Upgrade Interface

Step 3 Select the firmware update file from the storage device.

Step 4 Click **Upgrade** to start upgrading.

Step 5 After the upgrade is complete, the device will reboot automatically to activate the new firmware.

18.7.2 Upgrade by FTP

Before You Start

Ensure the network connection of the PC (running FTP server) and the device are valid and correct. Run the FTP server on the PC and copy the firmware into the corresponding directory of your PC.

Step 1 Go to **Maintenance>Upgrade**.

Step 2 Click the **FTP** tab to enter the local upgrade interface.

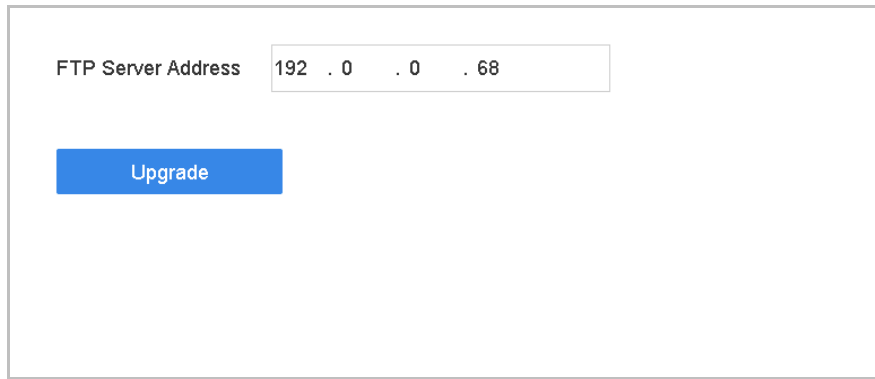

Figure 18-9 FTP Upgrade Interface

Step 3 Enter **FTP Server Address** in the text field.

Step 4 Click **Upgrade** to start upgrading.

Step 5 After the upgrading is complete, reboot the device to activate the new firmware.

18.8 Restore Default Settings

Step 1 Go to **Maintenance > Default**.

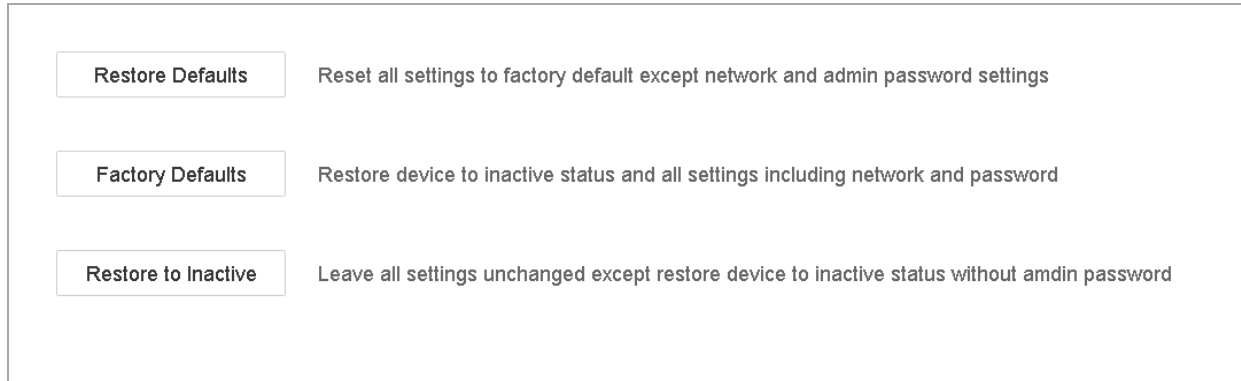

Figure 18-10 Restore Defaults

Step 2 Select the restore type from the following three options.

Restore Defaults: Restore all parameters, except the network (including IP address, subnet mask, gateway, MTU, NIC working mode, default route, server port, etc.) and user account parameters, to the factory default settings.

Factory Defaults: Restore all parameters to the factory default settings.

Restore to Inactive: Restore the device to inactive status.

 **NOTE**

The device will reboot automatically after restoring to the default settings.

Chapter 19 General System Settings

19.1 Configure General Settings

Purpose:

You can configure the BNC output standard, VGA output resolution, and mouse pointer speed in the **System > General** interface.

Step 1 Go to **System > General**.

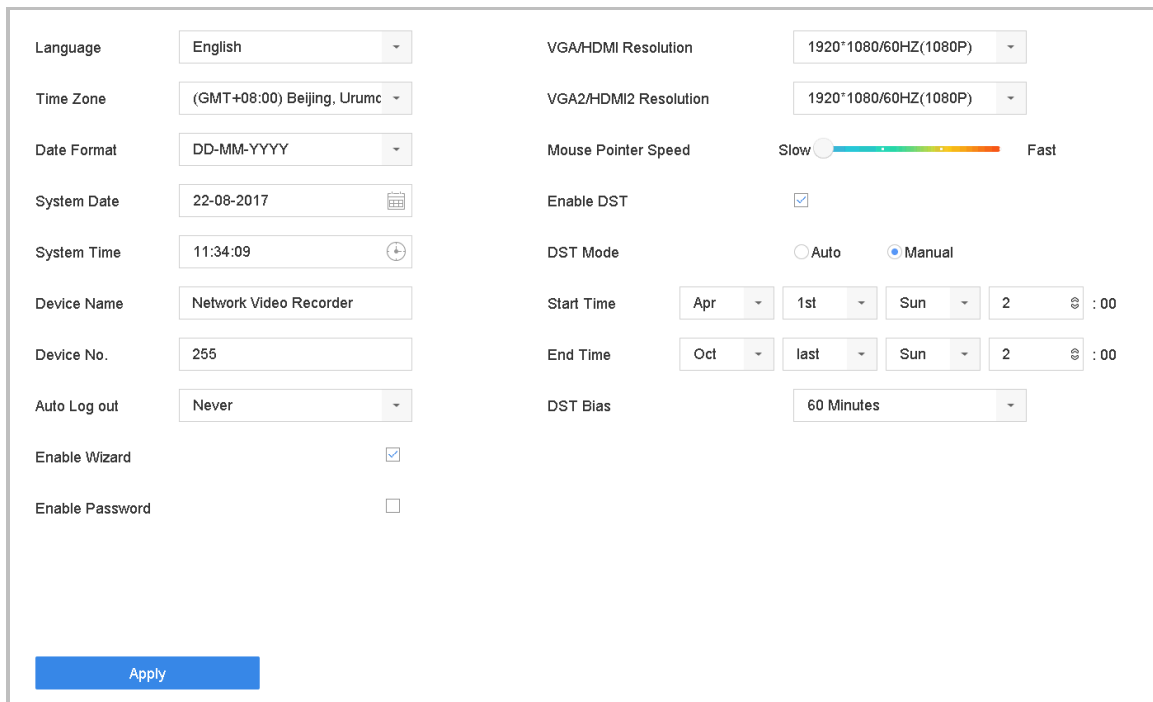

Figure 19-1 General Settings Interface

Step 2 Configure the following settings.

Language: The default language used is *English*.

Output Standard: Set the output standard to NTSC or PAL, which must be the same as the video input standard.

Resolution: Configure video output resolution.

Device Name: Edit device name.

Device No.: Edit the device serial number. The Device No. can be set in the range of 1 to 255, and the default No. is 255. The number is used for the remote and keyboard control.

Auto Logout: Set the timeout time for menu inactivity. E.g., when the timeout time is set to 5 minutes, then the system will exit from the current operation menu to Live View screen after 5 minutes of menu inactivity.

Mouse Pointer Speed: Set the speed of the mouse pointer; 4 levels are configurable.

Enable Wizard: Enable/disable the Wizard when the device starts up.

Enable Password: Enable/disable the use of the login password.

Step 3 Click **Apply** to save the settings.

19.2 Configure Date & Time

Step 1 Go to **System > General**.

Step 2 Configure the date and time.

Time Zone: Select the time zone.

Date Format: Select the date format.

System Date: Select the system date.

System Time: Set the system time.

Time Zone	(GMT+08:00) Beijing, Urumc	▼
Date Format	DD-MM-YYYY	▼
System Date	22-08-2017	📅
System Time	11:34:09	🕒

Figure 19-2 Date and Time Settings

Step 3 Click **Apply** to save the settings.

19.3 Configure DST Settings

DST (daylight saving time) refers to the period of the year when clocks are moved one period ahead. In some areas worldwide, this has the effect of creating more sunlit hours in the evening during months when the weather is the warmest.

We advance our clocks ahead a certain period (depends on the DST bias you set) at the beginning of DST, and move them back the same period when we return to standard time (ST).

Step 1 Go to **System > General**.

Step 2 Check **Enable DST**.

The screenshot shows the DST Settings interface with the following configuration:

- Enable DST:**
- DST Mode:** Auto Manual
- Start Time:** Apr 1st Sun 2 :00
- End Time:** Oct last Sun 2 :00
- DST Bias:** 60 Minutes

Figure 19-3 DST Settings Interface

Step 3 Set the DST mode to **Auto** or **Manual**.

- **Auto:** Automatically enable the default DST period according to the local DST rules.
- **Manual:** Manually set the start time and end time of the DST period, and the DST bias.

DST Bias: Set the time (30/60/90/120 minutes) offset from the standard time.

Example: DST begins at 2:00 a.m. on the second Sunday of March and ends at 2:00 a.m. on the first Sunday of November, with 60 minutes ahead.

Step 4 Click **Apply** to save the settings.

Chapter 20 Appendix

20.1 Glossary

- **Dual Stream:** Dual stream is a technology used to record high resolution video locally while transmitting a lower resolution stream over the network. The two streams are generated by the device, with the main stream having a maximum resolution of 4CIF and the sub-stream having a maximum resolution of CIF.
- **HDD:** Acronym for Hard Disk Drive. A storage medium which stores digitally encoded data on platters with magnetic surfaces.
- **DHCP:** Dynamic Host Configuration Protocol (DHCP) is a network application protocol used by devices (DHCP clients) to obtain configuration information for operation in an Internet Protocol network.
- **HTTP:** Acronym for Hypertext Transfer Protocol. A protocol to transfer hypertext request and information between servers and browsers over a network
- **DDNS:** Dynamic DNS is a method, protocol, or network service that provides the capability for a networked device, such as a router or computer system using the Internet Protocol Suite, to notify a domain name server to change, in real time (ad-hoc) the active DNS configuration of its configured hostnames, addresses or other information stored in DNS.
- **PPPoE:** Stands for "Point-to-Point Protocol over Ethernet." PPPoE is a network configuration used for establishing a PPP connection over an Ethernet protocol.
- **Hybrid device:** A hybrid device is a combination of a DVR and device.
- **NTP:** Acronym for Network Time Protocol. A protocol designed to synchronize the clocks of computers over a network.
- **NTSC:** Acronym for National Television System Committee. NTSC is an analog television standard used in such countries as the United States and Japan. Each frame of an NTSC signal contains 525 scan lines at 60Hz.
- **Device:** Acronym for Network Video Recorder. A device can be a PC-based or embedded system used for centralized management and storage for IP cameras, IP Domes and other devices.
- **PAL:** Acronym for Phase Alternating Line. PAL is also another video standard used in broadcast televisions systems in large parts of the world. PAL signal contains 625 scan lines at 50Hz.
- **PTZ:** Acronym for Pan, Tilt, Zoom. PTZ cameras are motor driven systems that allow the camera to pan left and right, tilt up and down and zoom in and out.

- **USB:** Acronym for Universal Serial Bus. USB is a plug-and-play serial bus standard to interface devices to a host computer.

20.2 Troubleshooting

- **No image displayed on the monitor after starting up normally.**

Possible Reasons:

- No VGA or HDMI connections.
- Connection cable is damaged.
- Input mode of the monitor is incorrect.

Step 1 Verify the device is connected with the monitor via HDMI or VGA cable.

Step 2 If not, please connect the device with the monitor and reboot.

Step 3 Verify the connection cable is good.

Step 4 If there is still no image display on the monitor after rebooting, please check if the connection cable is good, and change a cable to connect again.

Step 5 Verify Input mode of the monitor is correct.

Step 6 Please check the input mode of the monitor matches with the output mode of the device (e.g. if the output mode of device is HDMI output, then the input mode of monitor must be the HDMI input). And if not, please modify the input mode of monitor.

Step 7 Check if the fault is solved by the step 1 to step 3.

Step 8 If it is solved, finish the process.

If not, please contact the engineer from Hikvision to do the further process.

- **There is an audible warning sound “Di-Di-Di-DiDi” after a new bought device starts up.**

Possible Reasons:

- No HDD is installed in the device.
- The installed HDD has not been initialized.
- The installed HDD is not compatible with the device or is broken-down.

Step 1 Verify at least one HDD is installed in the device.

- If not, please install the compatible HDD.



NOTE

Please refer to the *Quick Start Guide* for the HDD installation steps.

- If you don't want to install a HDD, go to Menu>System> Event>Normal Event>Exception, and uncheck the Audible Warning checkbox of “HDD Error”.

Step 2 Verify the HDD is initialized.

- 1) Go to Menu>Storage>Storage Device.
- 2) If the status of the HDD is “Uninitialized”, please check the checkbox of corresponding HDD and click the “Init” button.

Step 3 Verify the HDD is detected or is in good condition.

- 3) Select Menu>Storage>Storage Device.
- 4) If the HDD is not detected or the status is “Abnormal”, please replace the dedicated HDD according to the requirement.

Step 4 Check if the fault is solved by the step 1 to step 3.

If it is solved, finish the process.

If not, please contact the engineer from Hikvision to do the further process.

- **The status of the added IP camera displays as “Disconnected” when it is connected through Private Protocol. Select “Menu>Camera>Camera>IP Camera” to get the camera status.**

Possible Reasons:

- Network failure, and the device and IP camera lost connections.
- The configured parameters are incorrect when adding the IP camera.
- Insufficient bandwidth.

Step 1 Verify the network is connected.

- 1) Connect the device and PC with the RS-232 cable.
- 2) Open the Super Terminal software, and execute the ping command. Input “ping IP” (e.g. ping 172.6.22.131).



NOTE

Simultaneously press **Ctrl** and **C** to exit the ping command.

If there exists return information and the time value is little, the network is normal.

Step 2 Verify the configuration parameters are correct.

- 1) Go to Menu>Camera.
- 2) Verify the following parameters are the same with those of the connected IP devices, including IP address, protocol, management port, user name and password.

Step 3 Verify the whether the bandwidth is enough.

- 1) Go to Menu>Maintenance>Net Detect>Network Stat..
- 2) Check the usage of the access bandwidth, and see if the total bandwidth has reached its limit.

Step 4 Check if the fault is solved by the step 1 to step 3.

If it is solved, finish the process.

If not, please contact the engineer from Hikvision to do the further process.

- **The IP camera frequently goes online and offline and the status of it displays as “Disconnected”.**

Possible Reasons:

- The IP camera and the device versions are not compatible.
- Unstable power supply of IP camera.
- Unstable network between IP camera and device.
- Limited flow by the switch connected with IP camera and device.

Step 1 Verify the IP camera and the device versions are compatible.

- 1) Go to Menu>Camera, and view the firmware version of connected IP camera.
- 2) Go to Menu>Maintenance>System Info>Device Info and view the firmware version of device.

Step 2 Verify power supply of IP camera is stable.

- 1) Verify the power indicator is normal.
- 2) When the IP camera is offline, please try the ping command on PC to check if the PC connects with the IP camera.

Step 3 Verify the network between IP camera and device is stable.

- 3) When the IP camera is offline, connect PC and device with the RS-232 cable.
- 4) Open the Super Terminal, use the ping command and keep sending large data packages to the connected IP camera, and check if there exists packet loss.



NOTE

Simultaneously press **Ctrl** and **C** to exit the ping command.

Example: Input ping 172.6.22.131 -l 1472 -f.

Step 1 Verify the switch is not flow control.

Check the brand, model of the switch connecting IP camera and device, and contact with the manufacturer of the switch to check if it has the function of flow control. If so, please turn it down.

Step 2 Check if the fault is solved by the step 1 to step 4.

If it is solved, finish the process.

If not, please contact the engineer from Hikvision to do the further process.

- **No monitor connected with the device locally and when you manage the IP camera to connect with the device by web browser remotely, of which the status displays as Connected. And then**

you connect the device with the monitor via VGA or HDMI interface and reboot the device, there is black screen with the mouse cursor.

Connect the device with the monitor before startup via VGA or HDMI interface, and manage the IP camera to connect with the device locally or remotely, the status of IP camera displays as Connect. And then connect the device with the CVBS, and there is black screen either.

Possible Reasons:

After connecting the IP camera to the device, the image is output via the main spot interface by default.

Step 1 Enable the output channel.

Step 2 Go to Menu>System>Live View>General, and select video output interface in the drop-down list and configure the window you want to view.



NOTE

- The view settings can only be configured by the local operation of device.
- Different camera orders and window-division modes can be set for different output interfaces separately, and digits like “D1” and “D2” stands for the channel number, and “X” means the selected window has no image output.

Step 3 Check if the fault is solved by the above steps.

If it is solved, finish the process.

If not, please contact the engineer from Hikvision to do the further process.

- **Live view stuck when video output locally.**

Possible Reasons:

- Poor network between device and IP camera, and there exists packet loss during the transmission.
- The frame rate has not reached the real-time frame rate.

Step 1 Verify the network between device and IP camera is connected.

- When image is stuck, connect the RS-232 ports on PC and the rear panel of device with the RS-232 cable.
- Open the Super Terminal, and execute the command of “**ping 192.168.0.0 -l 1472 -f**” (the IP address may change according to the real condition), and check if there exists packet loss.



NOTE

Simultaneously press **Ctrl** and **C** to exit the ping command.

Step 2 Verify the frame rate is real-time frame rate.

Go to Menu>Camera>Encoding Parameters, and set the Frame rate to Full Frame.

Step 3 Check if the fault is solved by the above steps.

If it is solved, finish the process.

If not, please contact the engineer from Hikvision to do the further process.

- **Live view stuck when video output remotely via the Internet Explorer or platform software.**

Possible Reasons:

- Poor network between device and IP camera, and there exists packet loss during the transmission.
- Poor network between device and PC, and there exists packet loss during the transmission.
- The performances of hardware are not good enough, including CPU, memory, etc..

Step 4 Verify the network between device and IP camera is connected.

- 1) When image is stuck, connect the RS-232 ports on PC and the rear panel of device with the RS-232 cable.
- 2) Open the Super Terminal, and execute the command of “**ping 192.168.0.0 -l 1472 -f**” (the IP address may change according to the real condition), and check if there exists packet loss.



NOTE

Simultaneously press **Ctrl** and **C** to exit the ping command.

Step 5 Verify the network between device and PC is connected.

- 1) Open the cmd window in the Start menu, or you can press “windows+R” shortcut key to open it.
- 2) Use the ping command to send large packet to the device, execute the command of “ping 192.168.0.0 -l 1472 -f” (the IP address may change according to the real condition), and check if there exists packet loss.



NOTE

Simultaneously press **Ctrl** and **C** to exit the ping command.

Step 6 Verify the hardware of the PC is good enough.

Simultaneously press **Ctrl**, **Alt** and **Delete** to enter the windows task management interface, as shown in the following figure.

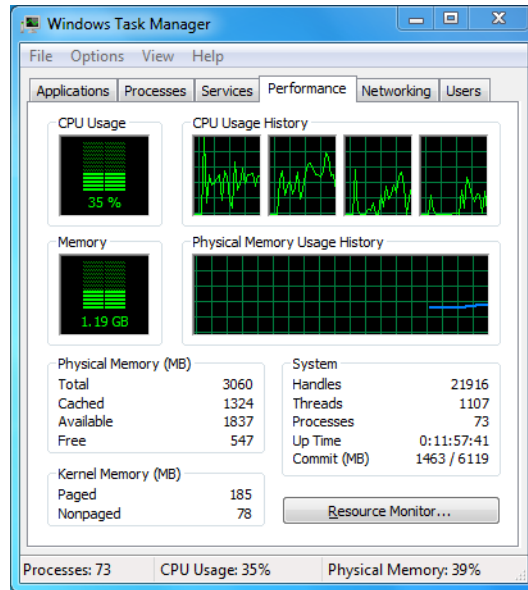

Figure 20-1 Windows task management interface

- Select the “Performance” tab; check the status of the CPU and Memory.
- If the resource is not enough, please end some unnecessary processes.

Step 7 Check if the fault is solved by the above steps.

If it is solved, finish the process.

If not, please contact the engineer from Hikvision to do the further process.

- **When using the device to get the live view audio, there is no sound or there is too much noise, or the volume is too low.**

Possible Reasons:

- Cable between the pickup and IP camera is not connected well; impedance mismatches or incompatible.
- The stream type is not set as “Video & Audio”.
- The encoding standard is not supported with device.

Step 1 Verify the cable between the pickup and IP camera is connected well; impedance matches and compatible.

Log in the IP camera directly, and turn the audio on, check if the sound is normal. If not, please contact the manufacturer of the IP camera.

Step 2 Verify the setting parameters are correct.

Go to Menu>Camera>Encoding Parameters, and set the Stream Type as “Audio & Video”.

Step 3 Verify the audio encoding standard of the IP camera is supported by the device.

The device supports G722.1 and G711 standards, and if the encoding parameter of the input audio is not one of the previous two standards, you can log in the IP camera to configure it to the supported standard.

Step 4 Check if the fault is solved by the above steps.

If it is solved, finish the process.

If not, please contact the engineer from Hikvision to do the further process.

- **The image gets stuck when device is playing back by single or multi-channel.**

Possible Reasons:

- Poor network between device and IP camera, and there exists packet loss during the transmission.
- The frame rate is not the real-time frame rate.
- The device supports up to 16-channel synchronize playback at the resolution of 4CIF, if you want a 16-channel synchronize playback at the resolution of 720p, the frame extracting may occur, which leads to a slight stuck.

Step 5 Verify the network between device and IP camera is connected.

- 1) When image is stuck, connect the RS-232 ports on PC and the rear panel of device with the RS-232 cable.
- 2) Open the Super Terminal, and execute the command of “**ping 192.168.0.0 -l 1472 -f**” (the IP address may change according to the real condition), and check if there exists packet loss.



NOTE

Simultaneously press the **Ctrl** and **C** to exit the ping command.

Step 6 Verify the frame rate is real-time frame rate.

Select “Menu > Record > Parameters > Record”, and set the Frame Rate to “Full Frame”.

Step 7 Verify the hardware can afford the playback.

Reduce the channel number of playback.

Go to Menu>Camera>Encoding Parameters, and set the resolution and bitrate to a lower level.

Step 8 Reduce the number of local playback channel.

Go to Menu>Playback, and uncheck the checkbox of unnecessary channels.

Step 9 Check if the fault is solved by the above steps.

If it is solved, finish the process.

If not, please contact the engineer from Hikvision to do the further process.

- **No record file found in the device local HDD, and prompt “No record file found”.**

Possible Reasons:

- The time setting of system is incorrect.
- The search condition is incorrect.
- The HDD is error or not detected.

Step 1 Verify the system time setting is correct.

Go to Menu>System>General, and verify the “Device Time” is correct.

Step 2 Verify the search condition is correct.

Go to playback interface, and verify the channel and time are correct.

Step 3 Verify the HDD status is normal.

Go to Menu>Storage>Storage Device to view the HDD status, and verify the HDD is detected and can be read and written normally.

Step 4 Check if the fault is solved by the above steps.

If it is solved, finish the process.

If not, please contact the engineer from Hikvision to do the further process.

20.3 Summary of Changes

Version 4.1.50

Added:

- Playback by video synopsis.
- Security questions configuration.
- Support event detection modes of thermal network cameras.
- Custom window-division live view layout configuration.
- System services: I-VIEW-NOW UPNP Reporting, Control4
- Stream encryption

Version 4.1.10

- Optimize the GUI information design.

Version 4.1.0

- Complete new GUI information design for more fluent and visual user experience.
- Files management and playback.
- HDD health monitoring for Seagate HDD.

Version 3.4.92

Added:

- Easy network access by Hik-Connect.

Deleted:

- Delete two DDNS types: IP sever and HiDDNS.

Version 3.4.91

Added:

- Support long distance (max.: 250-300 m) network transmission via PoE for /P models.
- Add prompt of using enterprise-level HDD to create array on GUI.

Version 3.4.90

Added:

- Reset the admin password by exporting/importing the GUID file.

- DS-7600/7700/9600-I (/P) series device support 3D positioning in live view.
- Configurable main stream and sub-stream for the live view.
- All-day continuous recording is configured by factory default.

Updated:

- Optimize the playback interface and add the configurable motion detection area for smart playback.
- Up to 2048 LRP lists supported in vehicle detection.

Version 3.4.80

Added:

- DS-7600/7700/9600-I (/P) series device is accessible by the thermal network camera, and supports the advanced search for fire/ship/temperature/temperature difference detection triggered alarm and the recorded video files and pictures.
- DS-7600/7700/9600-I (/P) series device supports the playback by main stream or sub stream.
- Remind user to remember the password after the device is activated.
- One-key alarm disarming for the local alarm input 1.

Updated:

- Optimize the playback by normal/smart interface.
- Admin Password changed to Password when adding the IP camera.

Deleted:

- Delete four VCA detection types: people gathering, fast movement, parking and loitering.

Version 3.4.70

Added:

- Add the POS function supported.

Version 3.4.6

Updated:

- Update the description of IR remote control operation.

Version 3.4.2

Added:

- Support the display of IP camera's password on the IP camera management interface.

- Add the configuration and use of unlock pattern for fast login.
- Add the fisheye expansion view for the connected fisheye camera in the live view and playback.
- Add the scaling display (30min/1h/2h/6h/24h) of time bar in the playback mode.
- Add the thumbnails view and fast view during playback.

Updated:

- Optimize the playback interface.
- Update the digital zoom operation in image.

Version 3.3.9

Updated:

- Support H.265 video encoding format.

Deleted:

- Delete the PPPoE settings.

Version 3.3.7

Added:

- Add the new models of DS-7700NI-K4(/P) and DS-7600NI-K2(/P).
- Add the front panel and rear panel of the new models.
- Add the specifications of the new models.

Version 3.3.6

Added:

- Add front panel and rear panel of DS-9600NI-I16.

Updated:

- DS-9600NI-I16 supports RAID6, capture, picture playback, eSATA HDD and eSATA backup, two self-adaptive 10M/100M/1000M network interfaces.

Version 3.3.4

Added:

- Add the new models of DS-7600NI-I2 (/P) and DS-7700NI-I4 (/P).
- Add the support of Cloud P2P.

20.4 List of IP Cameras Connected to PoE by Long Network Cable (100 - 300 m)

Index	Model
1	DS-2CD4665F-IZHS
2	DS-2CD4026FWD-AP
3	DS-2CD4A35FWD-IZHS
4	DS-2CD2642FWD-IZS
5	DS-2CD2F42FWD-IWS
6	DS-2CD2942F-IWS
7	DS-2CD2510F
8	DS-2CD2342WD-I
9	DS-2CD2322WD-I
10	DS-2CD2352-I
11	DS-2CD2642FWD-IZS
12	DS-2CD2642FWD-I
13	DS-2CD2642FWD-IS
14	DS-2CD2642FWD-IZ
15	DS-2CD2742FWD-IZS
16	DS-2CD2742FWD-I
17	DS-2CD2742FWD-IS
18	DS-2CD2742FWD-IZ
19	DS-2CD2T42WD-I8
20	DS-2CD2T42WD-I5

040110171012

