

# DH-IPC-HFW1420S

4MP Network IR Mini-Bullet Camera



- 1/3" 3Megapixel progressive CMOS
- H.264+ & H.264 dual-stream encoding
- 20fps@4M(2688×1520) & 25/30fps@3M(2304×1296)
- DWDR, Day/Night(ICR), 3DNR, AWB, AGC, BLC
- Multiple network monitoring: Web viewer, CMS(DSS/PSS) & DMSS
- 2.8 mm fixed lens (3.6 mm optional)
- Max IR LEDs Length 30m
- IP67, PoE



## System Overview

The IR Megapixel Fixed Mini-Bullet camera delivers 4MP resolution with a choice of 2.8mm, 3.6mm lens options. The camera's elegant blend of aesthetics combined with its compact form factor provides an excellent choice for a variety of small to mid-size, indoor/outdoor applications at an affordable price.

## Functions

### True Day/Night

A day/night mechanical IR cut filter makes this camera ideal for applications with fluctuating lighting conditions, delivering color images during the day and automatically switching to monochrome as the scene darkens

### Regions of interest

Regions of Interest (ROI) is a user defined feature that allows the operator to monitor specific areas of a scene while still maintaining overall situational awareness of less important areas

### Smart IR

With IR illumination, detailed images can be captured in low light or total darkness. The camera's Smart IR technology adjusts to the intensity of camera's infrared LEDs to compensate for the distance of an object. Smart IR technology prevents IR LEDs from whiting out images as they come closer to the camera. The camera's integrated infrared illumination provides high performance in extreme low-light environments up to 30m (98ft).

### Image flip

Capturing unnecessary data such as surrounding hallway walls can increase storage requirements without any added value. The image flip feature allows the camera's image to be rotated in 90° increments for better video optimization.

## Protection

Supporting  $\pm 10\%$  input voltage tolerance, this camera suits even the most unstable conditions for outdoor applications. Its 6KV lightning rating provides protection against the camera and its structure from the effects of lightning.

## Interoperability

The camera conforms to the ONVIF (Open Network Video Interface Forum) specifications, ensuring interoperability between network video products regardless of manufacturer

## Smart H.264+

Delivering high quality video without straining the network, Smart H.264+ is the optimized implementation of H.264. The Smart H.264+ encoding platform includes a scene adaptive encoding strategy, dynamic GOP, dynamic ROI, flexible multi-frame reference structure and intelligent noise reduction, providing a savings of up to 70% of bandwidth and storage when compared with standard H.264.

### Technical Specification

#### Camera

Image Sensor	1/3" 3Megapixel progressive CMOS
Effective Pixels	2688H)x1520(V)
RAM/ROM	256MB/16MB
Scanning System	Progressive
Electronic Shutter Speed	Auto/Manual, 1/3(4)~1/100000s
Minimum Illumination	0.31Lux/F2.2(Color), 0Lux/F2.2(IR on)
S/N Ratio	More than 40dB
IR Distance	Distance up to 30m(98ft)
IR On/Off Control	Auto/ Manual
IR LEDs	24

#### Lens

Lens Type	Fixed				
Mount Type	Board-in				
Focal Length	2.8 mm (3.6 mm optional)				
Max. Aperture	F2.0/F2.2				
Angle of View	H:106°/83°, V:56°/44°				
Focus Control	Fixed				
Close Focus Distance	N/A				
DORI Distance	Lens	Detect	Observe	Recognize	Identify
	2.8 mm	63m(207ft)	25m(82ft)	13m(43ft)	6m(20ft)
	3.6 mm	80m(262ft)	32m(105ft)	16m(52ft)	8m(26ft)

#### PTZ

Pan/Tilt Range	Pan:0° ~360° ;Tilt:0° ~90° ;Rotation:0° ~360°
----------------	---

#### Video

Compression	H.264+/H.264
Streaming Capability	2 Streams
Resolution	4M(2688x1520/2560x1440)/3M(2304x1296)/1080P(1920x1080)/720P(1280x720)/D1(704x576/704x480)/ CIF(352x288/352x240)
Frame Rate	4M(1 ~ 20fps)/3M (1 ~ 25/30fps)/2M (1 ~ 25/30fps) D1/CIF(1 ~ 25/30fps)
Bit Rate Control	CBR/VBR
Bit Rate	H264H:80K ~ 10240Kbps
Day/Night	Auto(ICR) / Color / B/W
BLC Mode	BLC / HLC / DWDR

White Balance	Auto/Natural/Street Lamp/Outdoor/Manual
Gain Control	Auto/Manual
Noise Reduction	3D DNR
Motion Detetion	Off / On (4 Zone, Rectangle)
Region of Interest	Off / On (4 Zone)
Electronic Image	Support
Smart IR	Support
Digital Zoom	16x
Flip	0°/90°/180°/270°
Mirror	Off / On
Privacy Masking	Off / On (4 Area, Rectangle)

#### Audio

Compression	N/A
-------------	-----

#### Network

Ethernet	RJ-45 (10/100Base-T)
Protocol	HTTP;HTTPS;TCP;ARP;RTSP;RTP;UDP;SMTP;FTP;DHCP;DNS;DDNS;PPPOE;IPv4/v6;QoS;UPnP;NTP;Bonjour;802.1x;Multicast;ICMP;IGMP;
Interoperability	ONVIF, PSIA, CGI
Streaming Method	Unicast / Multicast
Max. User Access	10 Users/20 Users
Edge Storage	NAS(Network Attached Storage) Local PC for instant recording
Web Viewer	IE, Chrome, Firefox, Safari
Management Software	Smart PSS, DSS, Easy4ip
Smart Phone	iPhone, iPad, Android Phone

#### Certifications

Certifications	CE (EN 60950:2000) UL:UL60950-1 FCC: FCC Part 15 Subpart B
----------------	--

#### Interface

Video Interface	N/A
Audio Interface	N/A
RS485	N/A
Alarm	N/A

#### Electrical

Power Supply	DC12V PoE(802.3af)(Class 0)
Power Consumption	<4.3W

Environmental

Operating Conditions	-30° C ~ +60° C (-22° F ~ +140° F) / Less than 95% RH
Storage Conditions	-30° C ~ +60° C (-22° F ~ +140° F) / Less than 95% RH
Ingress Protection	IP67
Vandal Resistance	N/A

Construction

Casing	Metal+Plastic
Dimensions	Ø70mm×164.7mm(2.76"×6.49")
Net Weight	0.38Kg(0.84lb)
Gross Weight	0.44Kg(0.97lb)

Ordering Information

Type	Part Number	Description
4MP camera	DH-IPC-HFW1420SP-0280B	4MP IR Mini-Bullet Network Camera, 2.8mm,PAL
	DH-IPC-HFW1420SN-0280B	4MP IR Mini-Bullet Network Camera, 2.8mm,NTSC
	IPC-HFW1420SP-280B	4MP IR Mini-Bullet Network Camera, 2.8mm,PAL
	IPC-HFW1420SN-0280B	4MP IR Mini-Bullet Network Camera, 2.8mm,NTSC
	DH-IPC-HFW1420SP-0360B	4MP IR Mini-Bullet Network Camera, 3.6mm,PAL
	DH-IPC-HFW1420SN-0360B	4MP IR Mini-Bullet Network Camera, 3.6mm,NTSC
	IPC-HFW1420SP-0360B	4MP IR Mini-Bullet Network Camera, 3.6mm,PAL
	IPC-HFW1420SN-0360B	4MP IR Mini-Bullet Network Camera, 3.6mm,NTSC
Accessories (optional)	PFA134	Junction box
	PFA150	Pole mount
	PFA151	Corner mount

Accessories

Optional:



PFA134 Junction Box



PFA150 Pole Mount



PFA151 Corner Mount

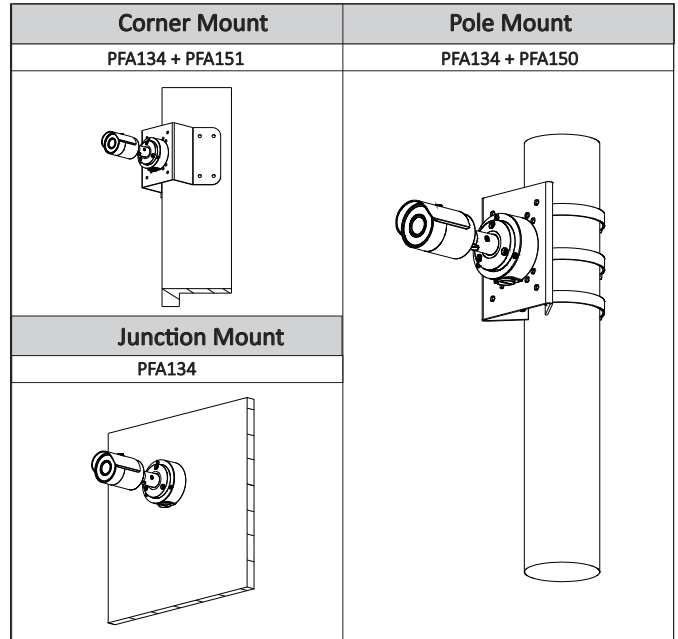

Dimensions (mm/inch)

